



HONDA

GL500 INTERSTATE
GL650 INTERSTATE

'83 ADDENDUM

HOW TO USE THIS MANUAL

Follow the Maintenance Schedule recommendations to ensure that the vehicle in peak operating condition and the emission levels are within the standards set by the U.S. Environmental Protection Agency. Performing the first scheduled maintenance is very important. It compensates for the initial wear that occurs during the break-in period.

All service procedures are based on the standard GL500. In those few instances where the Interstate model differs, the variations will be called out in the text or a note. Section 20, "Interstate Accessories" covers torque specifications and removal/reinstallation of accessories.

Sections 1 through 3 apply to the whole motorcycle, while sections 4 through 19 describe parts of the motorcycle, grouped according to location.

Find the section you want on this page, then turn to the table of contents on page 1 of that section.

Most sections start with an assembly or system illustration, service information and troubleshooting for the section. The subsequent pages give detailed procedures.

If you are not familiar with this motorcycle, read the TECHNICAL FEATURES in section 21.

If you don't know the source of the trouble, go to section 22, TROUBLESHOOTING.

Refer to section 23 for 1982 service information.

Refer to section 24 for 1983 GL650/INTERSTATE service information.

All information, illustrations, directions and specifications included in this publication are based on the latest product information available at the time of approval for printing. Honda Motor Co., Ltd. reserves the right to make changes at any time without notice and without incurring any obligation whatever. No part of this publication may be reproduced without written permission.

HONDA MOTOR CO., LTD.
Service Publications Office

CONTENTS

	GENERAL INFORMATION	1
	LUBRICATION	2
	MAINTENANCE	3
ENGINE	FUEL SYSTEM	4
	ENGINE REMOVAL/INSTALLATION	5
	CYLINDER HEAD/VALVE	6
	CLUTCH/OIL PUMP	7
	AC GENERATOR/FLYWHEEL/REAR COVER	8
	COOLING SYSTEM	9
	CAMSHAFT/CAM CHAIN	10
	TRANSMISSION	11
	CRANKSHAFT/PISTON	12
CHASSIS	FRONT WHEEL/SUSPENSION	13
	REAR WHEEL/BRAKE/FINAL DRIVE/SUSPENSION	14
	HYDRAULIC DISC BRAKE	15
ELECTRICAL	BATTERY/CHARGING SYSTEM	16
	IGNITION SYSTEM	17
	STARTER SYSTEM	18
	LIGHTS/SWITCHES	19
	INTERSTATE ACCESSORIES	20
TECHNICAL FEATURES	21	
TROUBLESHOOTING	22	
'82 GL500/INTERSTATE ADDENDUM	23	
'83 GL650/INTERSTATE ADDENDUM	24	



MODEL IDENTIFICATION

GL500

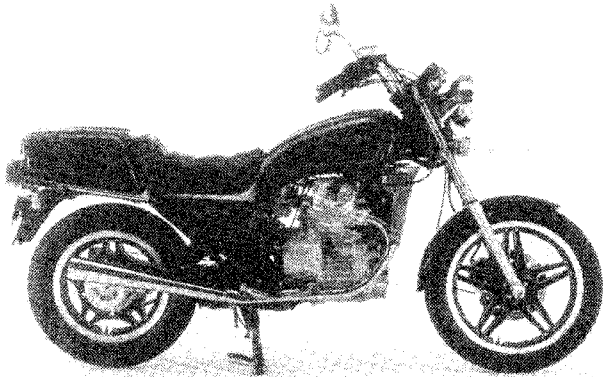

Beginning Frame Number: PC020 * BM000022 ~

NOTE: The asterisk (*) is part of the frame number.

The frame serial number is stamped on the right side of the steering head.

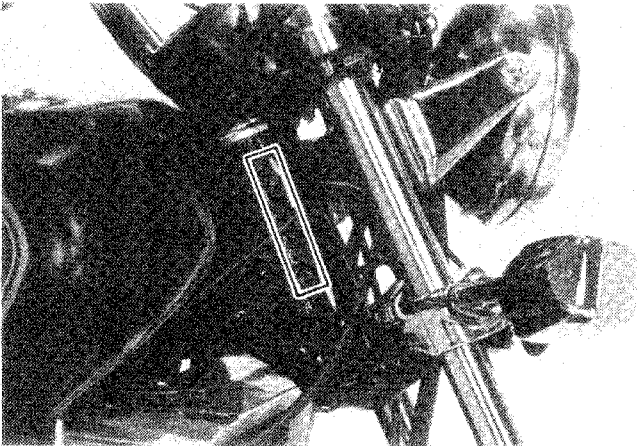

GL500I

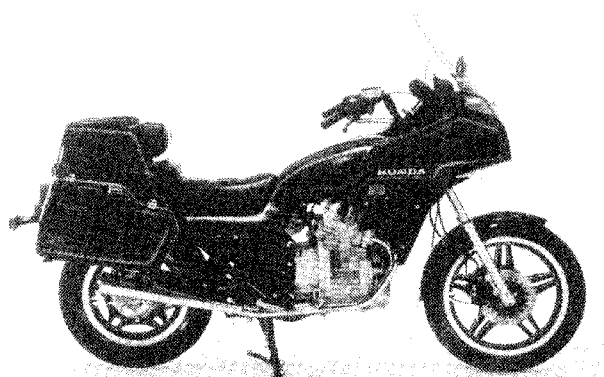

Beginning Frame Number: PC021 * BM000007 ~

The vehicle identification number is on the left side of the steering head.

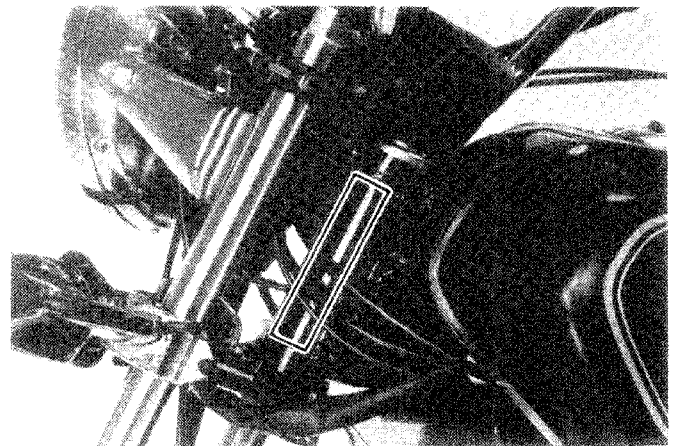

The engine serial number is stamped on the lower left side of the engine case.

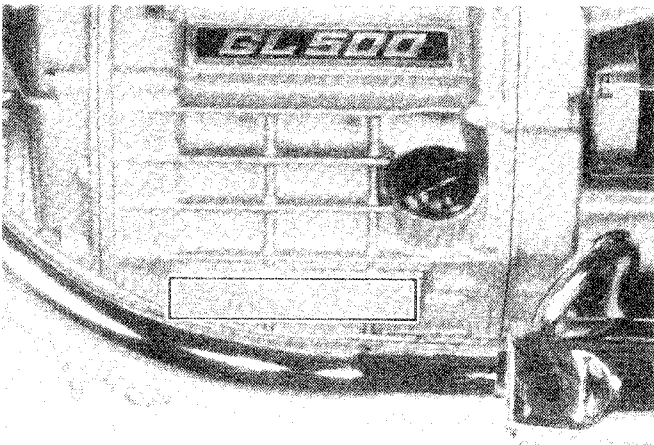

The carburetor identification number is on the left side of the carburetor body.

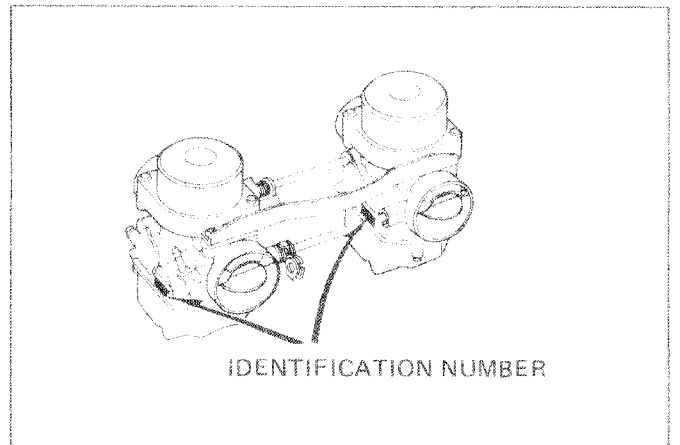

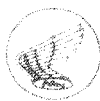

1. GENERAL INFORMATION

GENERAL SAFETY	1-1	CABLE & HARNESS ROUTING	1-7
SERVICE RULES	1-1	EMISSION CONTROL SYSTEM	1-9
SPECIFICATIONS	1-2	EMISSION CONTROL INFORMATION LABEL	1-9
TORQUE VALUES	1-4		
SPECIAL TOOLS/COMMON TOOLS	1-5		

GENERAL SAFETY

WARNING

If the engine must be running to do some work, make sure the area is well-ventilated. Never run the engine in a closed area. The exhaust contains poisonous carbon monoxide gas.

WARNING

Gasoline is extremely flammable and is explosive under certain conditions. Do not smoke or allow flames or sparks in your working area.

WARNING

The battery electrolyte contains sulfuric acid. Protect your eyes, skin and clothing. In case of contact, flush thoroughly with water and call a doctor if your eyes were exposed.

WARNING

The battery generates hydrogen gas which can be highly explosive. Do not smoke or allow flames or sparks near the battery, especially while charging it.

SERVICE RULES

1. Use genuine HONDA or HONDA-recommended parts and lubricants or their equivalent. Parts that do not meet HONDA's design specifications may damage the motorcycle.
2. Use the special tools designed for this product.
3. Use only metric tools when servicing this motorcycle. Metric bolts, nuts, and screws are not interchangeable with English fasteners. The use of incorrect tools and fasteners may damage the motorcycle.
4. Install new gaskets, O-ring cotter pins, lock plates, etc. when reassembling.
5. When tightening bolts or nuts, begin with larger-diameter or inner bolts first, and tighten to the specified torque diagonally, unless a particular sequence is specified.
6. Clean parts in cleaning solvent upon disassembly. Lubricate any sliding surfaces before reassembly.
7. After reassembly, check all parts for proper installation and operation.



SPECIFICATIONS

ITEM		GL500	GL500 INTERSTATE	
DIMENSIONS	Overall length	2,207 mm (86.9 in)	2,305 mm (90.7 in)	
	Overall width	875 mm (34.4 in)	875 mm (34.4 in)	
	Overall height	1,178 mm (46.4 in)	1,505 mm (59.2 in)	
	Wheel base	1,495 mm (58.8 in)	←	
	Seat height	788 mm (31.0 in)	778 mm (30.6 in)	
	Foot peg height	322 mm (12.7 in)	315 mm (12.4 in)	
	Ground clearance	132 mm (5.2 in)	127 mm (5.0 in)	
	Dry weight	207 kg (456 lbs)	230 kg (507 lbs)	
	Curb weight (Wet)	224 kg (494 lbs)	247 kg (547 lbs)	
FRAME	Type	Diamond		
	F. suspension, travel	Telescopic, 150 mm (5.9 in)		
	R. suspension, travel	Swing arm, 120 mm (4.7 in)		
	F. suspension air pressure	80–120 kPa (0.8–1.2 kg/cm ² , 11–17 psi)		
	R. suspension air pressure	0–500 kPa (0–5.0 kg/cm ² , 0–70 psi)	100–500 kPa (1.0–5.0 kg/cm ² , 14–70 psi)	
	Front tire size	3.50S19-4PR	Tubeless	
	Rear tire size	130/90-16 67S	Tubeless	
	Cold tire pressures	Up to 90 kg (200 lbs) load	Front Rear	200 kPa (2.0 kg/cm ² , 28 psi) 200 kPa (2.0 kg/cm ² , 28 psi)
		Up to vehicle capacity load	Front Rear	200 kPa (2.0 kg/cm ² , 28 psi) 250 kPa (2.5 kg/cm ² , 36 psi)
	F. brake and lining swept area	Single disc brake, 476 cm ² (73.8 sq.in)	Double disc brake, 812 cm ² (125.9 sq.in)	
R. brake and lining swept area	Internal expanding shoes, 201 cm ² (31.2 sq.in)			
Fuel capacity	17.6 lit (4.6 US gal, 3.9 Imp gal)			
Fuel reserve capacity	2.5 lit (0.7 US gal, 0.5 Imp gal)			
Caster angle	62°			
Trail length	117 mm (4.6 in)			
Front fork oil capacity	210 cc (7.1 oz) ATF after disassembly			
Rear shock oil capacity	163 cc (5.5 oz) ATF after draining 669 cc (22.6 oz) ATF			
ENGINE	Type, cylinder arrangement	Water cooled, 4 stroke O.H.V. engine		
	Engine weight	65 kg (143.3 lbs)		
	Bore and stroke	78 x 52 mm (3.071 x 2.047 in)		
	Displacement	497 cm ³ (30.3 cu-in)		
	Compression ratio	10.0 : 1		
	Cylinder compression	1,200 kPa (12.0 kg/cm ² , 171 psi)		
	Valve train	Chain driven camshaft and push rod		
	Oil capacity	3.6 lit (3.8 US qt, 3.1 Imp qt) after disassembly 3.0 lit (3.2 US qt, 2.6 Imp qt) after draining		
	Oil type	SAE 10W-40 SE, Honda 4-stroke oil or equivalent		
	Lubrication system	Forced pressure and wet sump		
	Air filtration system	Dry paper element		
	Cooling system capacity	2.0 lit (0.52 US gal, 0.44 Imp gal)		
	Radiator cap relief pressure	75–105 kPa (0.75–1.05 kg/cm ² , 10.7–14.9 psi)		



ITEM		GL500	GL500 INTERSTATE
ENGINE	Camshaft (at 1 mm lift)		
	Intake valve	Opens Closes	6° BTDC (at 1 mm lift), 79° BTDC (at 0 lift) 46° ABDC (at 1 mm lift), 123° ABDC (at 0 lift)
	Exhaust valve	Opens Closes	46° BBDC (at 1 mm lift), 114° BBDC (at 0 lift) 6° ATDC (at 1 mm lift), 85° ATDC (at 0 lift)
	Valve clearance (cold)	IN EX	0.08 mm (0.003 in) 0.10 mm (0.004 in)
	Idle speed		1,100 ± 100 rpm
CARBURETION	Carburetor type	VB type, 34 mm (1.3 in) venturi bore	
	Identification number	VB29A	
	Pilot screw	Refer to page 4-12	
	Float level	15.5 mm (0.61 in)	
DRIVE TRAIN	Clutch	Wet, multi-plate	
	Transmission	5-speed constant-mesh	
	Primary reduction ratio	2.242 (74/33)	
	Gear ratio 1st	2.733 (41/15)	
	Gear ratio 2nd	1.850 (37/20)	
	Gear ratio 3rd	1.416 (34/24)	
	Gear ratio 4th	1.148 (31/27)	
	Gear ratio 5th	0.931 (27/29)	
	Final reduction ratio	3.091 (34/11)	
	Gear shift pattern	Left foot operated return system 1-N-2-3-4-5	
	Final gear oil capacity	160--180 cc (5.4--6.1 oz)	
ELECTRICAL	Ignition	Transistorized	
	Ignition timing "F" mark	15° BTDC at idle	
	Full advance	45 ± 1.5° BTDC/3,000 rpm	
	Starting system	Starting motor	
	Alternator	AC generator, 12V-252W/5,000 rpm	
	Battery capacity	12V - 14AH	
	Spark plug		
	Standard	D8EA (NGK) or X24 ES-U (ND)	
	For extended high speed riding	D9EA (NGK) or X27 ES-U (ND)	
	For optional radio		
	Standard	DR8ES-L (NGK) or X24ESR-U (ND)	
	For extended high speed riding	DR8ES (NGK) or X27ESR-U (ND)	
	Spark plug gap	0.6--0.7 mm (0.024--0.028 in)	
	Fuse	10A, 30A (Main fuse)	5A, 10A, 30A (Main fuse)
LIGHTS	Headlight (High/Low)	12V--60/55W H4 bulb (Phillips 12342/99, or equivalent)	
	Tail/stoplight	12V--3/32 cp No. 1157	
	Turn signal light (Front)	12V--32 cp No. 1034	
	(Rear)	12V--32 cp No. 1073	
	Meter light	12V--2 cp No. 57	
	Neutral indicator	12V--2 cp No. 57	
	Turn signal indicator	12V--2 cp No. 57	
	High beam indicator	12V--2 cp No. 57	
	Oil pressure warning light	12V--2 cp No. 57	

TORQUE VALUES

ENGINE

ITEM	QTY	Thread Dia (mm)	Torque		
			N-m	kg-m	ft-lb
Crankshaft cap bolt	7	8	20-24	2.0-2.4	14-17
Connecting rod cap nut	4	8	28-32	2.8-3.2	20-23
Cylinder head bolt	8	12	50-60	5.0-6.0	36-43
Valve adjuster lock nut	8	6	15-18	1.5-1.8	11-13
Flywheel bolt	1	12	90-105	9.0-10.5	65-76
Clutch center lock nut	1	20	80-100	8.0-10.0	58-72
Primary drive gear bolt	1	12	80-95	8.0-9.5	58-69
Starting clutch torx bolt	3	8	18-25	1.8-2.5	13-18
Cooling fan bolt	1	8	20-25	2.0-2.5	14-18
Cam sprocket lock nut	1	20	80-100	8.0-10.0	58-72
Cam sprocket bolt	2	7	16-20	1.6-2.0	12-14
Radiator drain bolt	1	12	1.5-3.0	0.15-0.30	1.1-2.2

FRAME

Engine mount bolt	2	12	60-80	6.0-8.0	43-58
Engine mount bolt	4	10	45-70	4.5-7.0	33-51
Front engine hanger nut	4	10	30-40	3.0-4.0	22-29
Front axle nut	1	12	55-65	5.5-6.5	40-47
Front axle holder nut	4	8	18-25	1.8-2.5	13-18
Steering stem nut	1	24	90-120	9.0-12.0	65-87
Fork bridge pinch bolt	2	7	9-15	0.9-1.5	7-11
Steering stem pinch bolt	2	10	30-40	3.0-4.0	22-29
Handlebar holder bolt	4	8	25-35	2.5-3.5	18-25
Rear axle nut	1	14	50-80	5.0-8.0	36-58
Final driven flange bolt	5	10	40-50	4.0-5.0	29-36
Rear shock absorber mount bolt	2	10	45-55	4.5-5.5	33-40
Shock linkage pivot bolt	4	10	45-55	4.5-5.5	33-40
Rear brake stopper arm bolt	2	8	15-25	1.5-2.5	11-18
Foot peg bolt	2	10	30-40	3.0-4.0	22-29
Passenger foot peg bolt	2	10	45-60	4.5-6.0	33-43
Rear brake pedal bolt	1	6	10-15	1.0-1.5	7-11
Gear shift pedal bolt	1	6	10-14	1.0-1.4	7-10
Swing arm pivot bolt	1	30	9-12	0.9-1.2	7-9
Swing arm pivot lock nut	1	30	90-120	9.0-12.0	65-87
Drive shaft lock bolt	1	8	18-28	1.8-2.8	13-20
Rear axle pinch bolt	1	8	20-30	2.0-3.0	14-22
Final gear case nut	3	10	45-70	4.5-7.0	33-51
Front brake caliper mount bolt	2	10	30-45	3.0-4.5	22-33
Front brake caliper pivot bolt	1	12	25-30	2.5-3.0	18-22
Front brake caliper bolt	1	8	20-25	2.0-2.5	14-18
Exhaust pipe joint nut	4	6	8-14	0.8-1.4	6-10
Muffler band bolt	4	8	18-28	1.8-2.8	13-20
Brake pedal stopper bolt	1	6	6-9	0.6-0.9	4-7
Side stand pivot bolt	1	10	10-20	1.0-2.0	7-14
Side stand pivot nut	1	10	30-40	3.0-4.0	22-29
Fuel valve nut	1	18	20-25	2.0-2.5	14-18
Main stand bolt	2	10	30-40	3.0-4.0	22-29
Air cleaner case	2	6	6-9	0.6-0.9	4-7
Power chamber bolt	3	8	24-30	2.4-3.0	17-22
Rear fender bolt	2	14	30-40	3.0-4.0	22-29

Torque specifications listed above are for the most important tightening points. If a torque specification is not listed, follow the standards given below.

STANDARD TORQUE VALUES

Type	Torque N-m (kg-m, ft-lb)	Type	Torque N-m (kg-m, ft-lb)
5 mm bolt, nut	4.5-6.0 (0.45-0.6, 3.3-4.3)	5 mm screw	3.5-5.0 (0.35-0.5, 2.5-3.6)
6 mm bolt, nut	8-12 (0.8-1.2, 6-9)	6 mm screw	7-11 (0.7-1.1, 5-8)
8 mm bolt, nut	18-25 (1.8-2.5, 13-18)	6 mm flange bolt, nut	10-14 (1.0-1.4, 7-10)
10 mm bolt, nut	30-40 (3.0-4.0, 22-29)	8 mm flange bolt, nut	24-30 (2.4-3.0, 17-22)
12 mm bolt, nut	50-60 (5.0-6.0, 36-43)	10 mm flange bolt, nut	30-40 (3.0-4.0, 22-29)



SPECIAL TOOLS/COMMON TOOLS

SPECIAL

Asterisked (*) tools are new for the GL500 and GL500I

DESCRIPTION	NUMBER	ALTERNATE TOOL	NUMBER	REF. PAGE
* Pinion gear retainer wrench	07910-MA10100	Pinion gear retainer wrench	07910-4150000	14-31
* Pinion gear puller attachment	07934-MA10100			14-34
* Pinion gear puller catcher	07934-MA10200			14-34
* Oil seal driver	07965-MA10100			14-12, 14-13
* Oil seal driver attachment	07965-MA10200			14-12, 14-13
* Oil seal guide	07973-MA10100			14-32
* O-ring guide	07973-MA10200			14-32
* Socket bit 17 mm	07703-0020500			14-17, 14-23
Vacuum gauge	07404-0020000	Equivalent tools commercially available U.S.A.	M937B-021-XXXXX	3-9
(Vacuum gauge attachment)	(07510-3000100)			Vacuum gauge set
Torx driver bit	07703-0010100	Equivalent tools commercially available in U.S.A.		8-6
Piston slider	07755-0010000			12-18
Socket wrench 17 x 27 mm	07907-4150000			10-3
Pivot lock nut wrench	07908-4690001	Swingarm locknut wrench	KS-ABA-08-469	14-17, 14-23
Ring gear retainer wrench	07910-3710100			14-28
Circlip pliers	07914-3230001	Equivalent tools commercially available in U.S.A.		13-14, 15-6
Allen wrench 6 mm	07917-3230000			13-13
Clutch center holder	07923-4150000			7-3, 7-7
Gear holder	07924-4150000			8-4, 10-3, 12-6
Crank cap puller	07935-4150000	(Use hydraulic press)		12-7
Bearing remover 20 mm	07936-3710000			11-7, 11-8
Bearing remover attachment 20 mm	07936-3710600			11-7, 11-8
Bearing remover handle	07936-3710100			11-7, 11-8
Bearing remover weight	07936-3710200			11-7, 11-8
Needle bearing remover	07936-8890300			14-19
Piston remover	07941-4150000			12-3
Valve guide driver attachment	07943-4150000			6-9
Bearing driver attachment	07945-3330300			8-9, 13-25
Crank cap driver set	07945-4150100			11-3, 12-14
Ring gear center guide	07965-4150100			12-15
Mechanical seal driver attachment	07945-4150400	Driver	07945-3710200	9-7
Seal driver attachment	07945-4150200			14-20, 14-21, 14-32
Ball race driver attachment	07946-3290000	Ball race remover/installer	07946-3710400	13-24
Steering stem driver	07946-3710601			13-24
Fork seal driver attachment	07947-KA20200			13-17
Ball race remover	07953-KA50000	Race remover	07953-4250002	13-24
Ring gear dis/assembly tool set	07965-4150001			14-29
Ring gear dis/assembly tool A	07965-4150201			14-29
Ring gear dis/assembly tool B	07965-3710200			14-29
Main bearing dis/assembly tool	07973-4150000			12-11, 12-13
Valve guide reamer	07984-6110000	Valve guide reamer	07984-6570100	6-8, 6-10
Preload or preload inspection tool	07998-4150000			14-27, 14-33
Carburetor synchronizing wrench	07908-4600200			3-9
Hand vacuum pump	A973X-041-XXXXX			4-14
Timing inspection plug	07999-4150000			17-6

GENERAL INFORMATION



COMMON

DESCRIPTION	NUMBER	ALTERNATE TOOL	NUMBER	REF. PAGE
Float level gauge	07401-0010000			4-10
Pin spanner	07702-0010000	Adjustable pin spanner		13-22, 13-25
Valve adjuster wrench 10 x 12 mm	07708-0030200	Valve adjuster wrench	07908-3640000	3-8
Valve adjusting wrench	07708-0030400			3-8
Bearing retainer wrench B	07710-0010200	Retainer wrench	07910-3230101	13-8, 14-7
Bearing retainer wrench body	07710-0010401			13-8, 14-7
Lock nut wrench 26 x 30 mm	07716-0020202			7-3, 7-7
Steering stem socket 30 x 32 mm	07716-0020400	Equivalent tools commercially available in U.S.A.		13-22
Extension	07716-0020500			7-3
Rotor puller	07733-0010000	Rotor puller	07933-0010000	9-6
Flywheel puller	07733-0020001	Flywheel puller	07933-3950000	8-5
Valve guide remover 5.6 mm	07742-0010200	Valve guide driver	07942-6110000	6-9
			or	
Pin driver 3.5 mm	07744-0010300	Pin driver 3.5 mm	07942-6570100	
Attachment 32 x 35 mm	07746-0010100	Attachment	07944-6340100	14-18
		Attachment	07946-3640000	11-10
		Attachment	07946-6920100	
Attachment 37 x 40 mm	07746-0010200	Attachment	07946-4250100	14-20, 14-21
Attachment 42 x 47 mm	07746-0010300	Attachment	07945-3330100	11-10, 13-10
				14-8
Attachment 52 x 55 mm	07746-0010400	Attachment	07946-3710200	11-10
Attachment 62 x 68 mm	07746-0010500	Attachment	07946-3600000	11-10
Pilot 15 mm	07746-0040300			13-10, 14-8
Pilot 20 mm	07746-0040500			11-10
Pilot 22 mm	07746-0041000			8-9
Pilot 25 mm	07746-0040600			11-10
Pilot 30 mm	07746-0040700			14-30
Driver	07749-0010000			8-9, 9-7, 11-10
Fork oil seal driver	07747-0010100			13-7
Valve spring compressor	07757-0010000	Valve spring compressor	07957-3290001	6-7, 6-13

CABLE AND HARNESS ROUTING

GL500

GENERAL INFORMATION

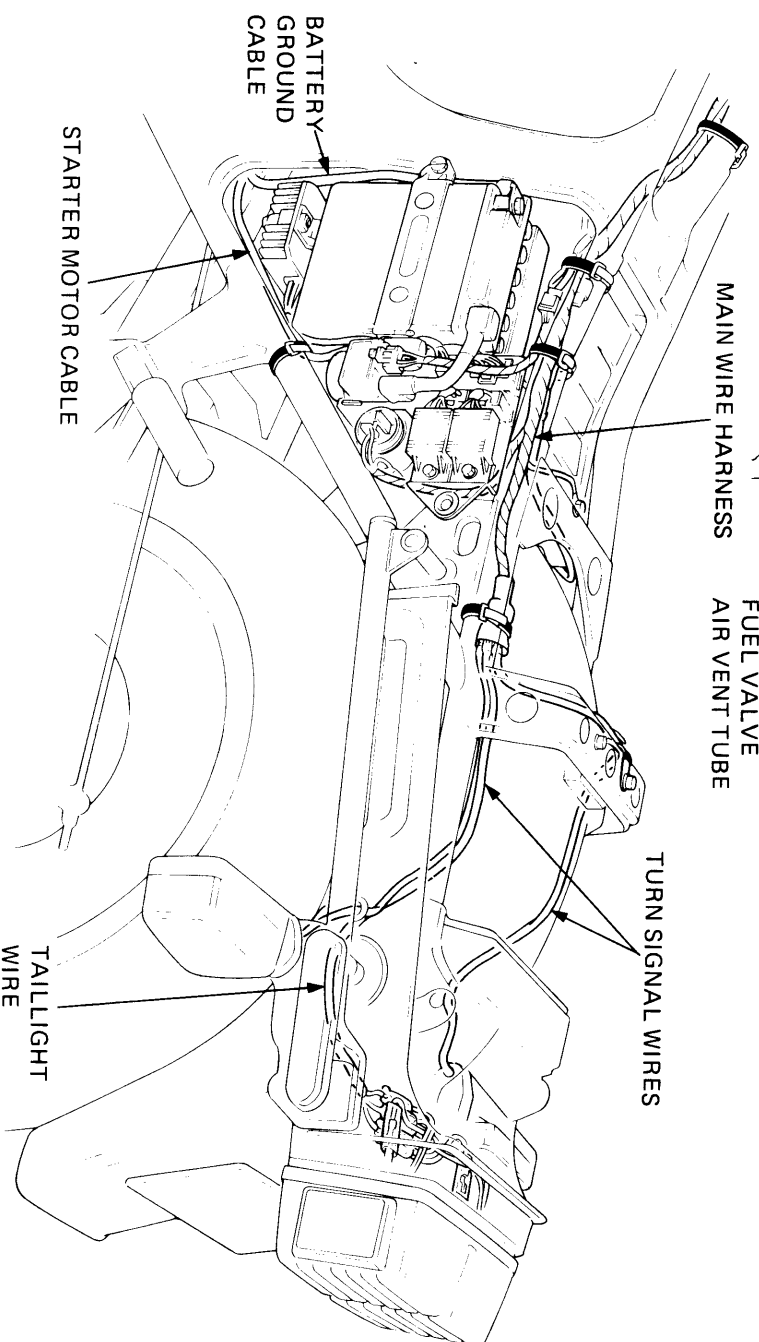
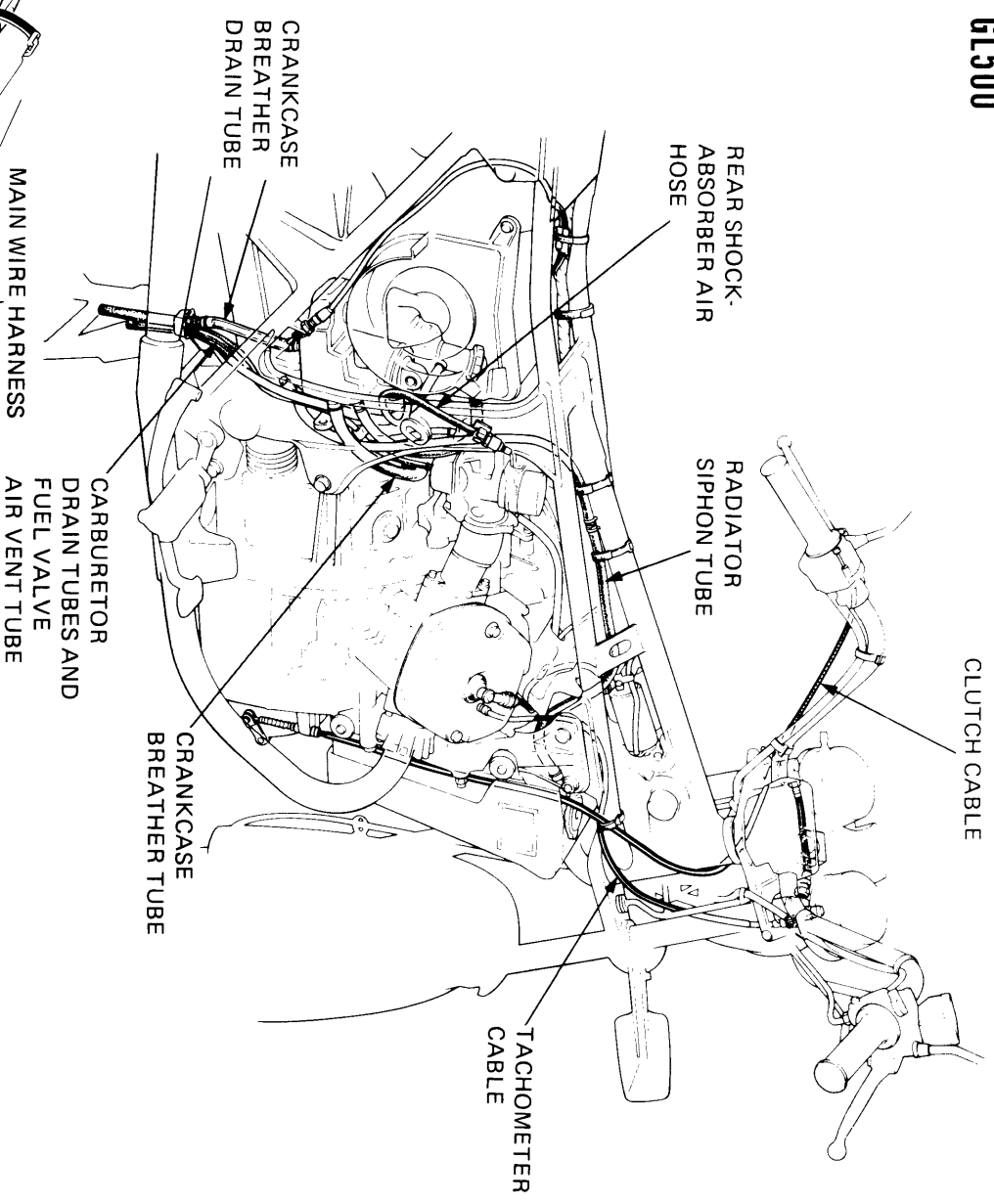
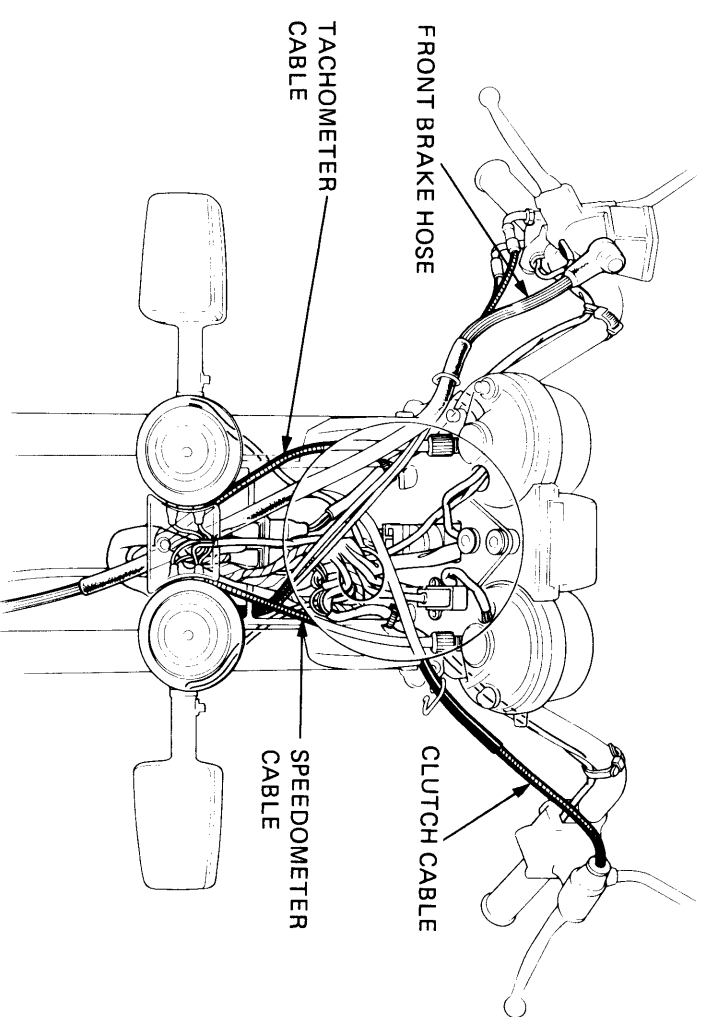
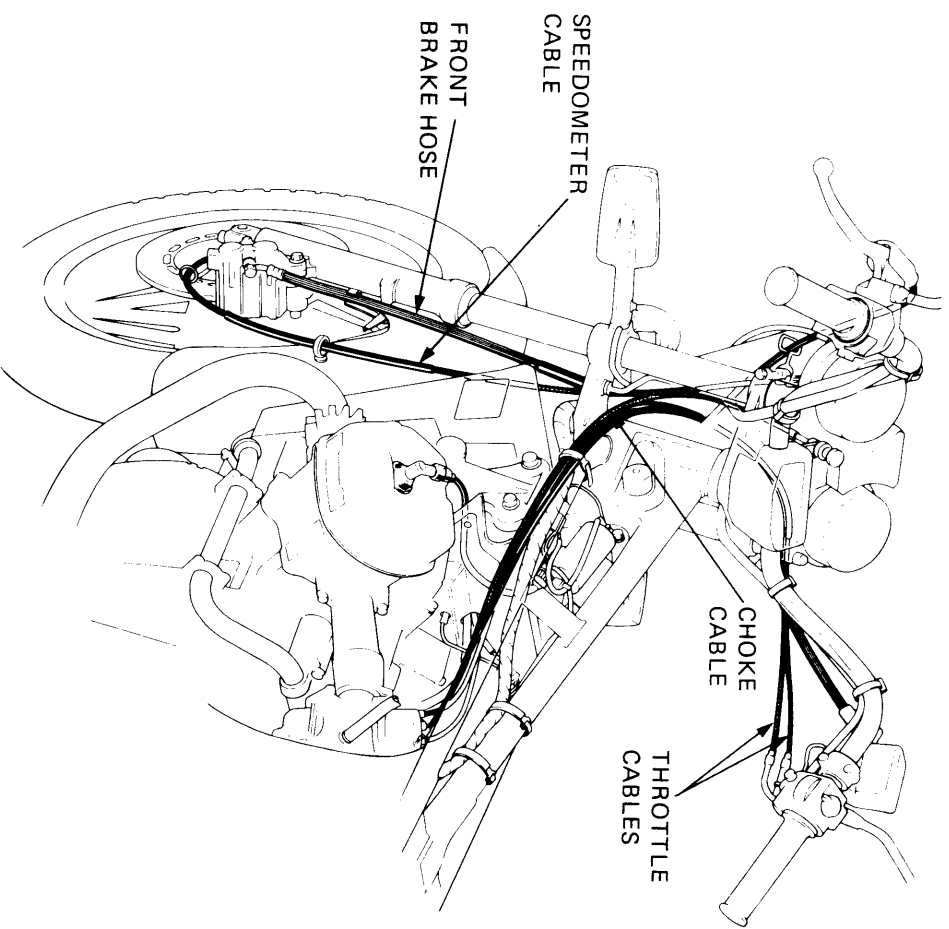

GL500 INTERSTATE



HONDA
GL500
INTERSTATE

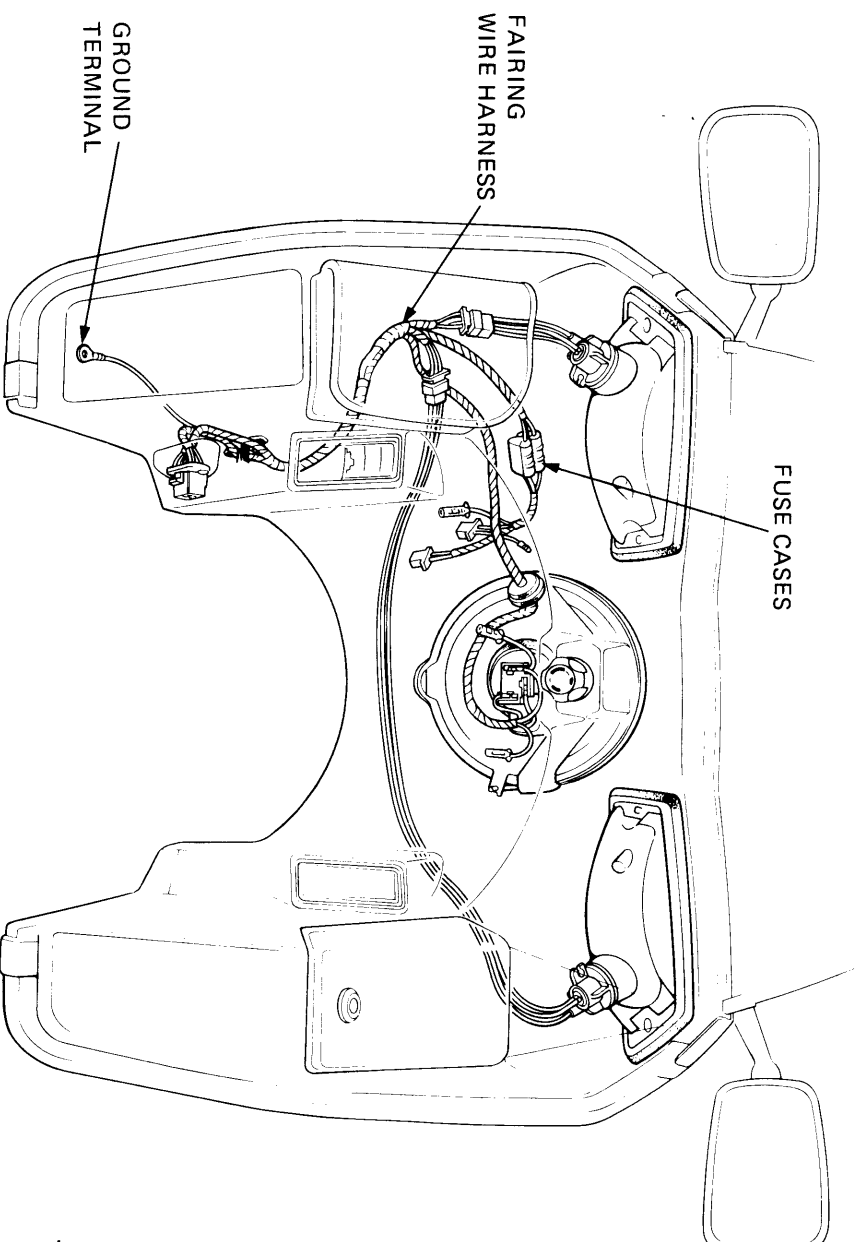
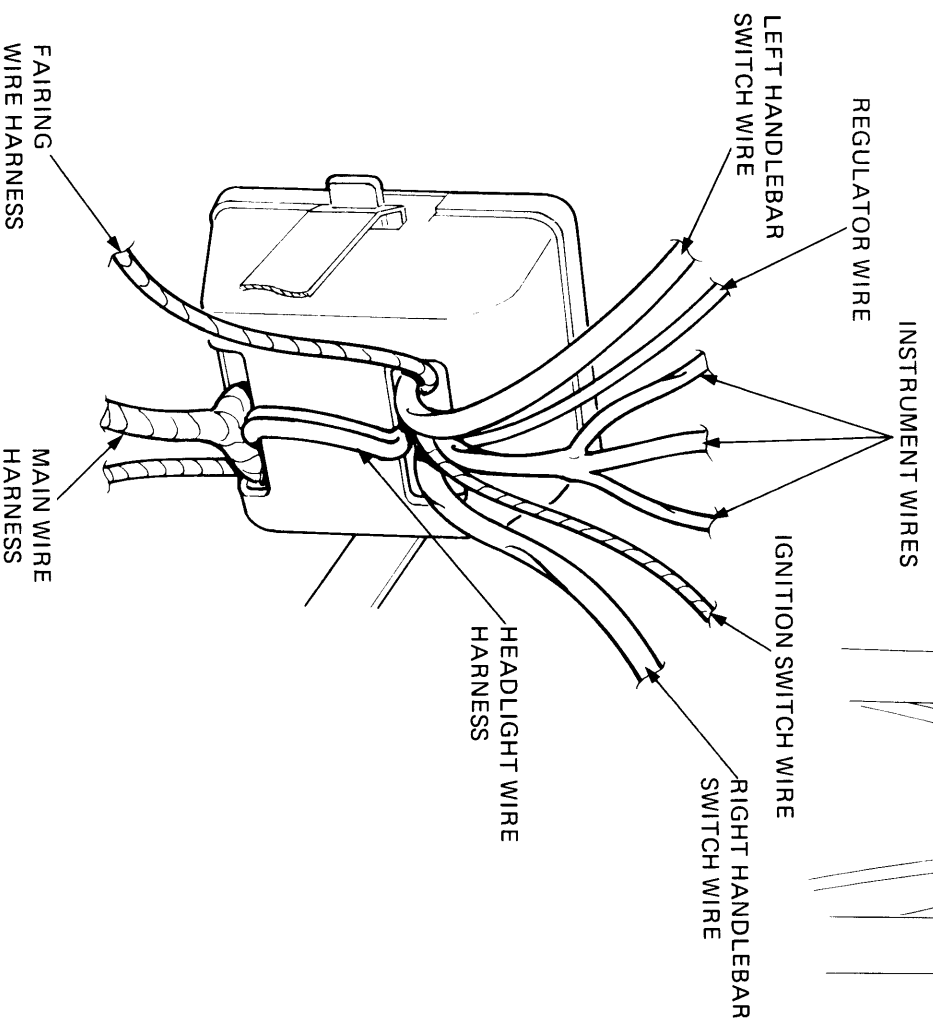
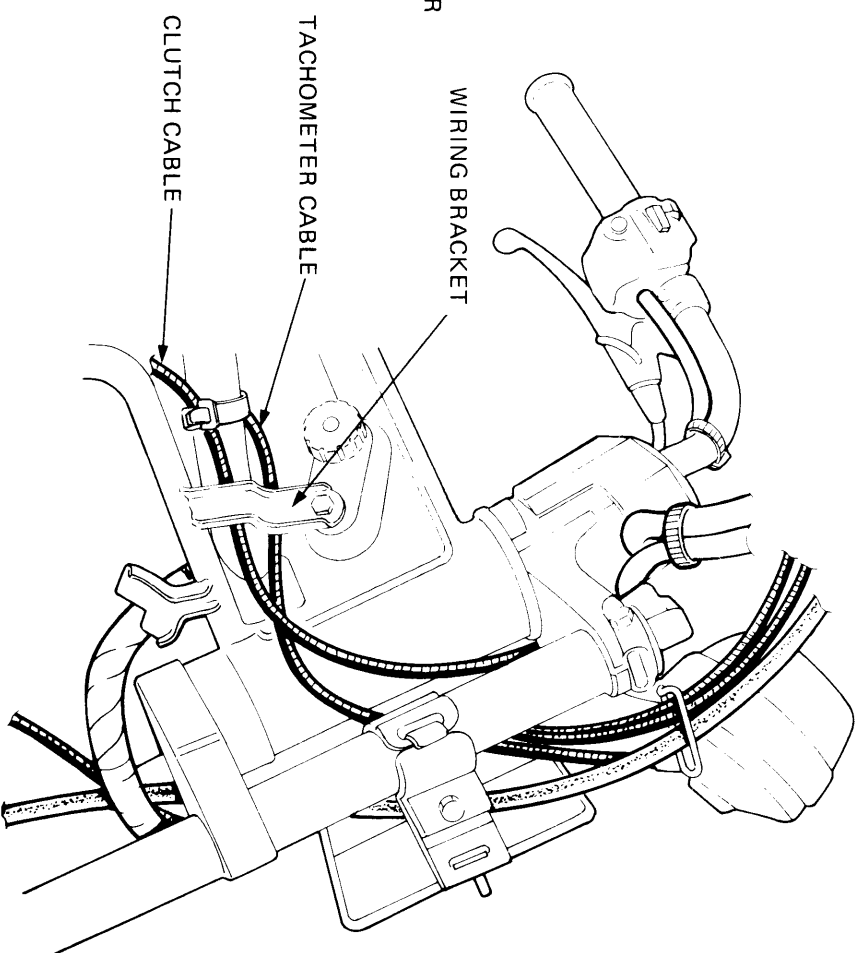
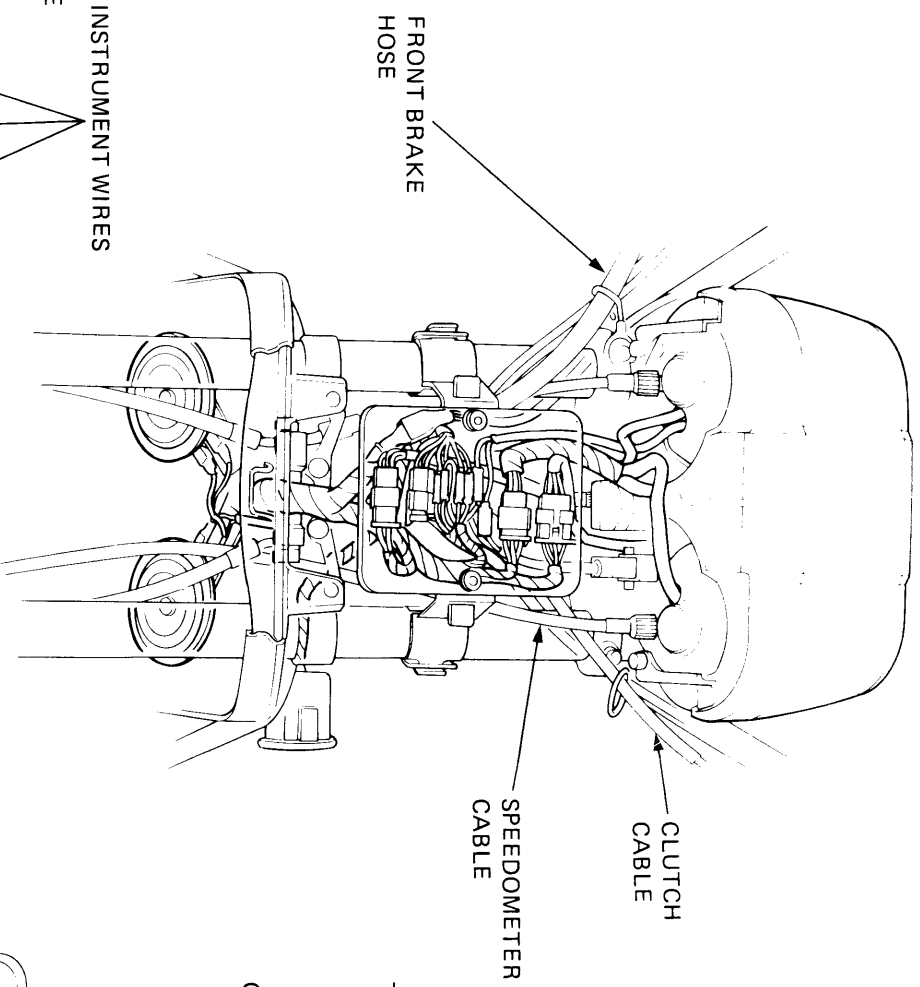

EMISSION CONTROL SYSTEM

The GL500 is equipped with two emission control systems.

- **EXHAUST EMISSION CONTROL SYSTEM**

The exhaust emission control system is composed of a factory pre-set carburetor. No adjustment should be made except to the idle speed with the throttle stop screw.

- **CRANKCASE EMISSION CONTROL SYSTEM**

The engine is equipped with a "closed crankcase system" to prevent crankcase emissions from entering the atmosphere. Blow-by gas is returned to the combustion chamber through the breather tube, separator and intake pipe.

CRANKCASE EMISSION CONTROL SYSTEM

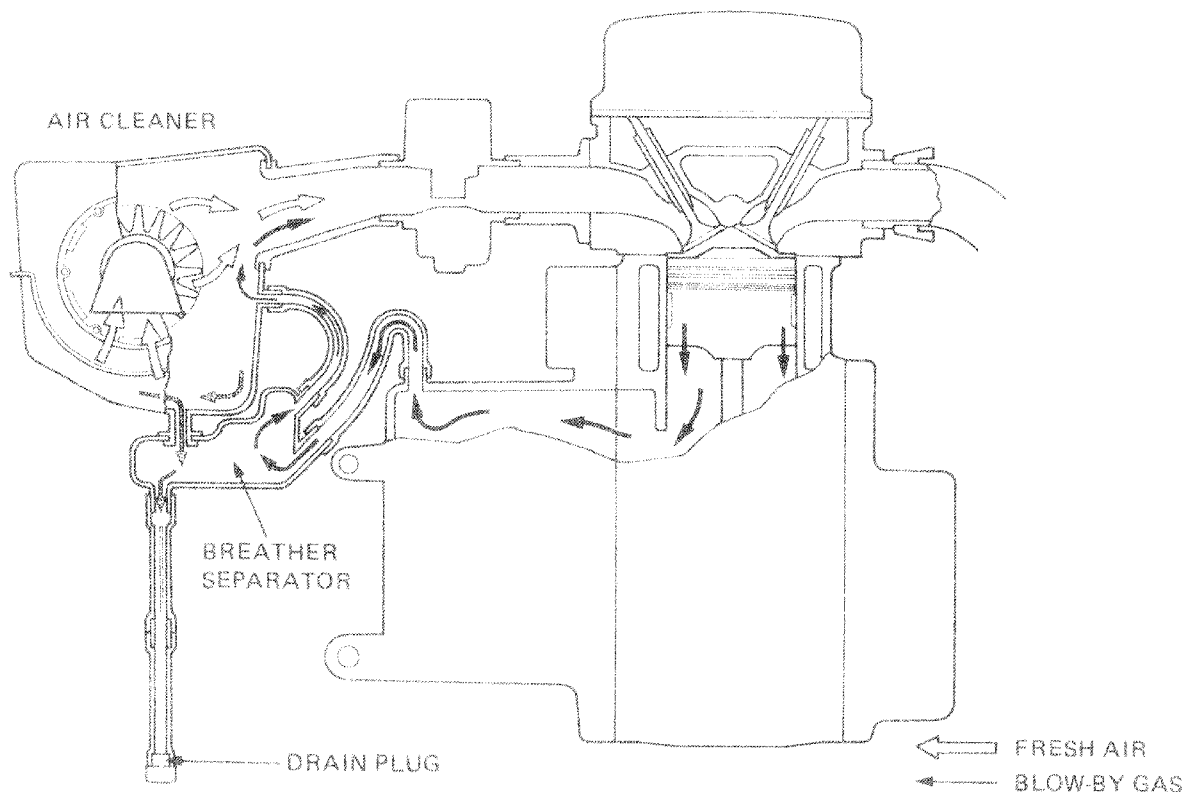

EMISSION CONTROL INFORMATION LABEL

An Emission Control Information Label is located on the frame as shown. It gives basic tune-up specifications.

EMISSION CONTROL INFORMATION LABEL

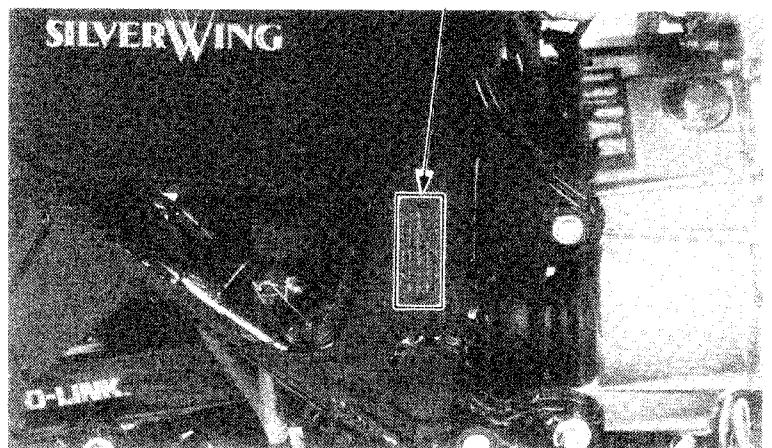



LUBRICATION

LUBRICATION DIAGRAM

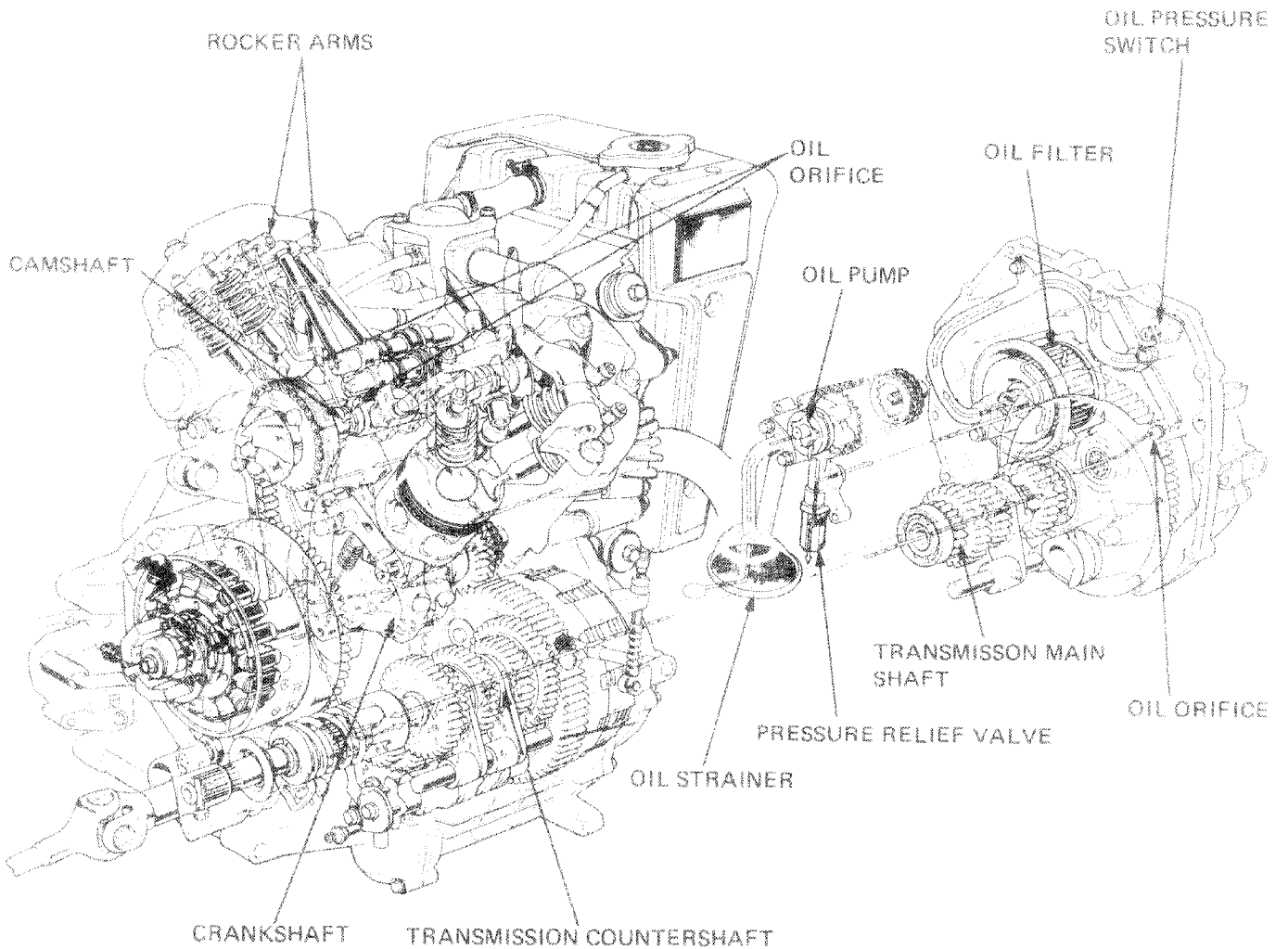



2. LUBRICATION

SERVICE INFORMATION	2-1
TROUBLESHOOTING	2-1
ENGINE OIL LEVEL CHECK	2-2
ENGINE OIL & OIL FILTER CHANGE	2-2
FINAL GEAR OIL CHECK/REPLACEMENT	2-3
DRIVE SHAFT JOINT	2-3
CONTROL CABLE LUBRICATION	2-3
LUBRICATION POINTS	2-4

SERVICE INFORMATION

GENERAL INSTRUCTIONS

Oil pump	Refer to Section 7.
Oil pressure relief valve	Refer to Section 7.
Oil strainer	Refer to Section 7.

SPECIFICATIONS

Engine Oil

Oil capacity	2.5 lit (2.6 US qt, 2.2 Imp qt) at change 3.0 lit (3.2 US qt, 2.6 Imp qt) at disassembly
Oil recommendation	Use HONDA 4-STROKE OIL or equivalent. API SERVICE CLASSIFICATION: SE VISCOSITY: SAE 10W-40 Other viscosities shown in the chart may be used when the average temperature in your riding area is within the indicated range.
Oil pump delivery	9.3 - 9.5 lit/min at 3,000 rpm

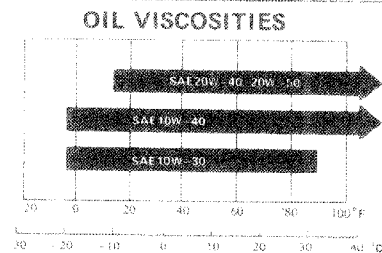

Final drive gear

Oil capacity	160 - 180 cc (5.4 - 6.1 oz)		
Recommended oil	Hypoid gear oil	Above 5°C/41°F	SAE 90
		Below 5°C/41°F	SAE 80

TROUBLESHOOTING

Oil Level Too Low:

1. Normal oil consumption
2. External oil leaks
3. Worn piston rings

Oil Contamination

1. Oil or filter not changed often enough
2. Defective head gasket

Low Oil Pressure

1. Faulty warning light switch
2. Pressure relief valve stuck open
3. Plugged oil pick-up screen
4. Oil pump worn

High Oil Pressure:

1. Pressure relief valve stuck closed
2. Plugged oil filter, gallery, or metering orifice
3. Incorrect oil being used

No Oil Pressure

1. Oil level too low
2. Oil pump drive chain broken
3. Faulty oil pump

LUBRICATION
ENGINE OIL LEVEL CHECK

Place the motorcycle on its center stand. Check the oil level with the filler cap dipstick after 2–3 minutes. Do not screw in the cap when making this check. If the level is below the lower level mark on the dipstick, fill to the upper level mark with the recommended oil.

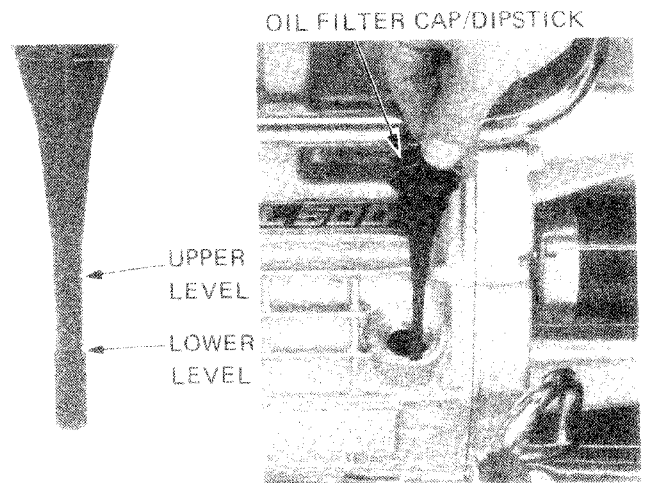
ENGINE OIL & OIL FILTER CHANGE
NOTE

Engine oil change is performed with the engine at normal operating temperature and vehicle on its center stand to ensure complete and rapid draining.

Remove the oil filler cap.
 Remove the drain plug to drain oil from the engine.

NOTE

Crank the engine for 2–3 seconds to drain any residual oil.

Screw out the oil filter bolt and remove the oil filter element from the oil filter case. Check operation of the by-pass valve in the oil filter bolt. Install a new oil filter element and retighten the oil filter bolt.

NOTE

Make sure that the O-ring on the filter bolt and the oil filter cover are not damaged and are in good condition.

Torque the oil filter bolt.

TORQUE: 20–25 N·m
 (2.0–2.5 kg·m, 14–18 ft·lb)

Reinstall the drain plug.
 Making sure the sealing washer is in good condition. Fill the engine with 2.5 liters (2.6 U.S. qt) of recommended oil.

RECOMMENDED OIL:

Use **HONDA 4-STROKE OIL** or equivalent.
 API Service Classification: **SE**
 General, all temperatures: **SAE 10W-40**

Stop the engine, make sure that the oil level is at the upper level mark, and there are no oil leaks.

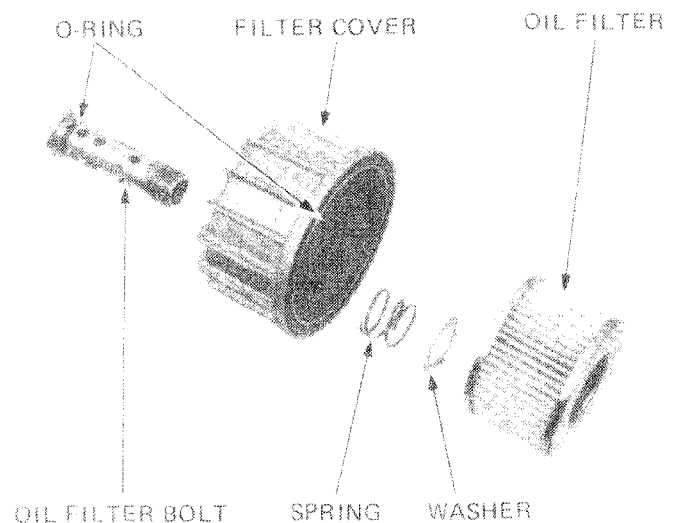
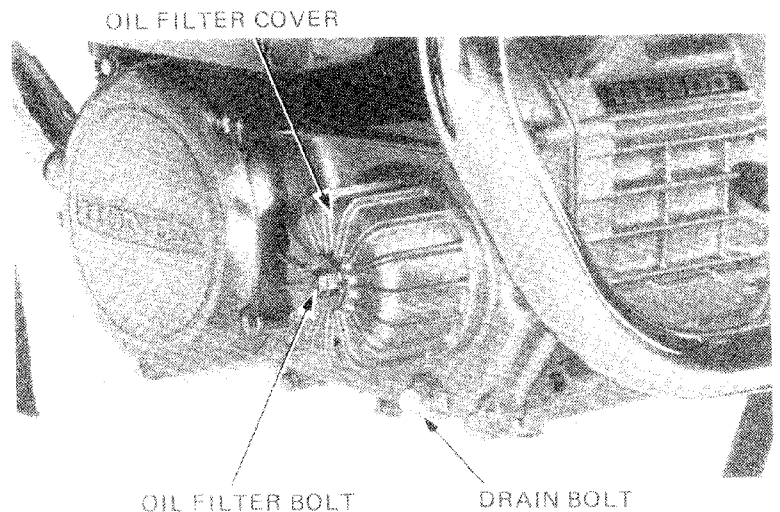



FINAL GEAR OIL CHECK/REPLACEMENT

OIL LEVEL CHECK

Place the motorcycle on its center stand.
Remove the oil filler cap.
Check that the final gear case is filled up to the lower edge of the oil filler cap hole.

NOTE

If the level is low, check for leaks. Pour fresh oil through the oil filler opening until it reaches the lower edge of the opening.

OIL REPLACEMENT

Remove the oil filler cap.
Remove the drain bolt to drain all oil from the final gear case.
Reinstall the drain bolt securely.
Fill the gear case with the recommended oil up to the correct level.

OIL CAPACITY: 160–180 cc (5.4–6.1 oz)

RECOMMENDED OIL: HYPOID GEAR OIL

SAE 90 (Above 5°C/41°F)

SAE 80 (Below 5°C/41°F)

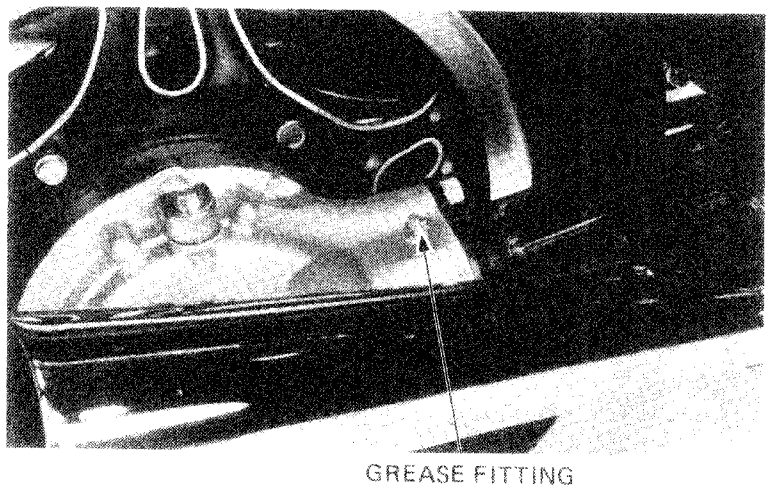
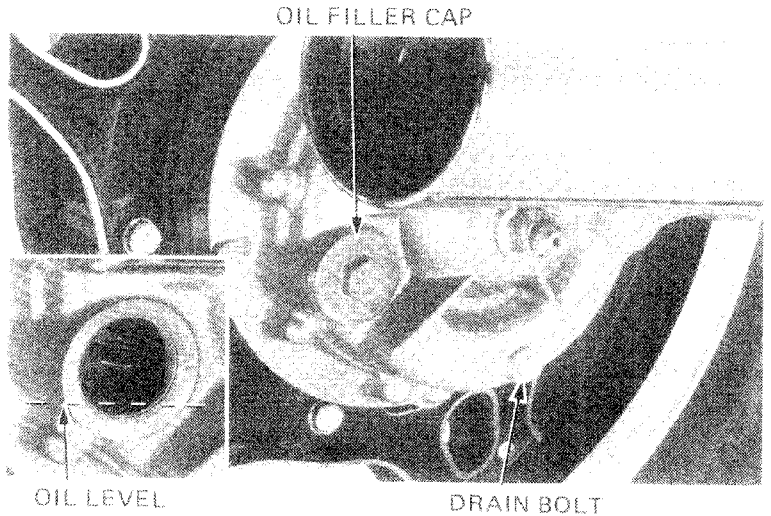

DRIVE SHAFT JOINT

Apply approx. 18gr. (20 cc 1.2 cu-in) lithium-based MULTIPURPOSE NLGI No. 2 (with molybdenum disulfide-MoS₂-additive) GREASE through the drive shaft joint grease fitting.

NOTE

Use lithium-based MULTIPURPOSE grease with MoS₂-additive as follows:

- MOLYKOTE® BR2-S manufactured by Dow Corning, U.S.A.
- MULTIPURPOSE M-2 manufactured by Mitsubishi Oil, Japan.
- Other lubricants of equivalent quality.

CONTROL CABLE LUBRICATION

Periodically, disconnect the throttle and clutch cables at their upper ends.
Thoroughly lubricate the cables and their pivot points with a commercially available cable lubricant.



LUBRICATION

LUBRICATION POINTS

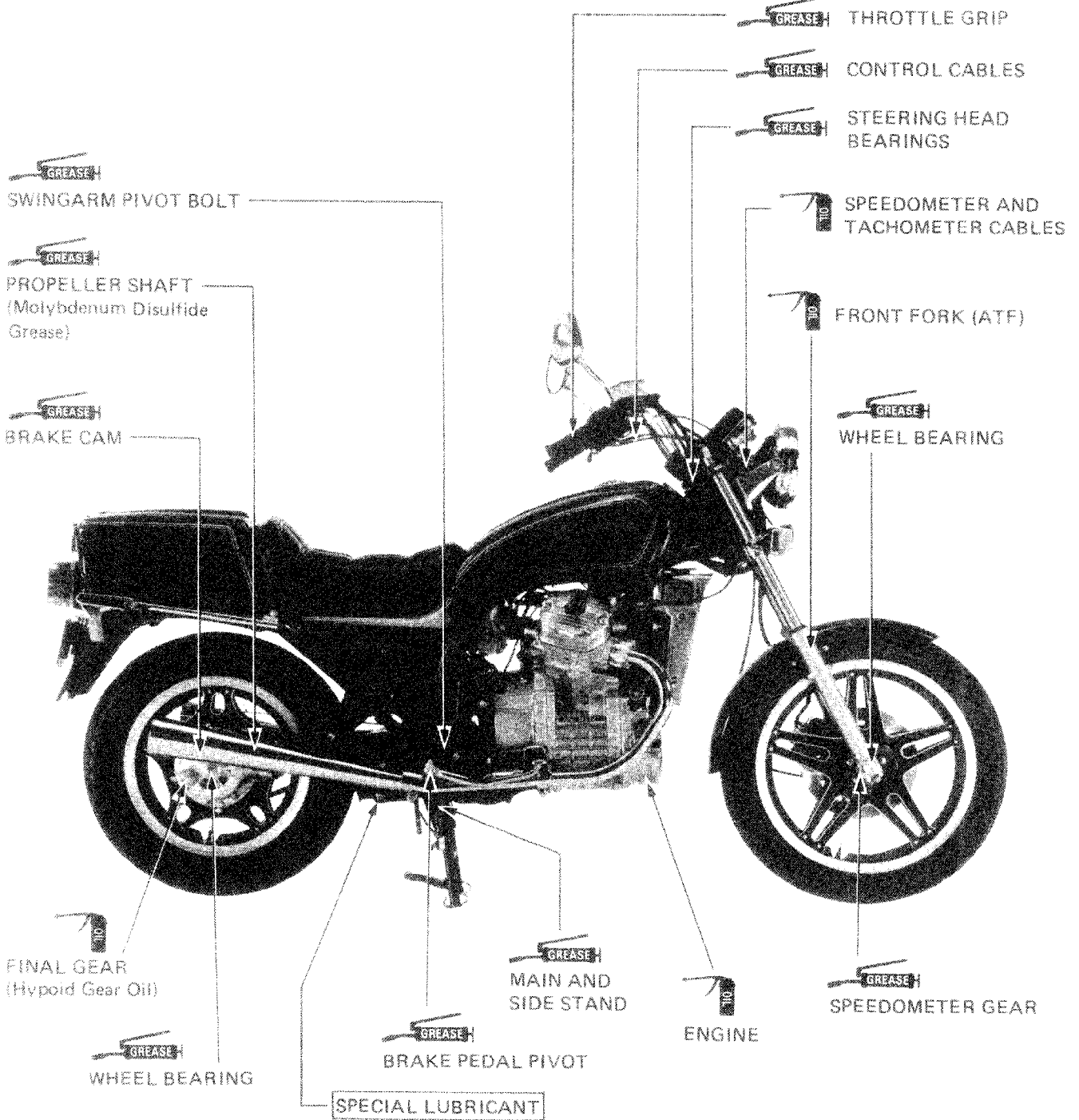

- SHOCK ABSORBER UPPER MOUNT BUSHINGS (page 14-26)
- SUSPENSION LINKAGE PIVOTS (page 14-26)



3. MAINTENANCE

SERVICE INFORMATION	3-1	COOLING SYSTEM HOSES	3-11
MAINTENANCE SCHEDULE	3-3	< CHASSIS >	
< ENGINE >		BATTERY	3-11
FUEL LINES	3-4	BRAKE FLUID	3-11
THROTTLE OPERATION	3-4	BRAKE SHOE/PAD WEAR	3-12
CARBURETOR CHOKE	3-5	BRAKE SYSTEM	3-12
AIR CLEANER	3-5	BRAKELIGHT SWITCH	3-13
CRANKCASE BREATHER	3-6	HEADLIGHT AIM	3-13
SPARK PLUGS	3-7	CLUTCH	3-14
VALVE CLEARANCE	3-7	SIDE STAND	3-14
CAM CHAIN TENSION	3-9	SUSPENSION	3-15
CARBURETOR-SYNCHRONIZATION	3-9	NUTS, BOLTS, FASTENERS	3-16
CARBURETOR-IDLE SPEED	3-10	WHEELS	3-16
RADIATOR COOLANT	3-10	STEERING HEAD BEARINGS	3-17
RADIATOR CORE	3-10		

SERVICE INFORMATION

GENERAL INSTRUCTIONS

- Engine oil See page 2-2
- Engine oil filter See page 2-2
- Final drive gear oil See page 2-3
- Drive shaft joint See page 2-3

TOOLS

Special

- Vacuum gauge 07404-0020000 or M937B-021-XXXXX (USA only)
- Carb synchronization wrench 07908-4600200

Common

- Valve adjusting wrench 10 x 12 mm : 07708-0030200
 - Valve adjuster B : 07708-0030400
- } 07908-3640000

SPECIFICATIONS

< Engine >

Spark plug: Recommended spark plug

	GL500, GL500I		For optional radio	
	Standard	For extended high speed riding	Standard	For extended high speed riding
NGK	D8EA	D9EA	DR8ES-L	DR8ES
ND	X24ES-U	X27ES-U	X24ESR-U	X27ESR-U

Plug gap : 0.6 - 0.7 mm (0.02 - 0.03 in)

Ignition timing:

- "F" mark : 15° BTDC at 1,100 rpm
- Full advance : 45 ± 1.5° BTDC at 3,000 rpm

Valve clearance (IN) : 0.08 mm (0.003 in)

EX : 0.10 mm (0.004 in)

Throttle free play : 2 - 6 mm (0.08 - 0.24 in)

Idle speed : 1,100 ± 100 rpm

Vacuum pressure difference

between carburetors : 40 mm (1.6 in) Hg

Compression : 1,200 ± 200 kPa (12 ± 2 kg/cm², 171 ± 28 psi)

Clutch free play : 10 - 20 mm (3/8 - 3/4 in)



MAINTENANCE

CHASSIS

Rear brake pedal free play: 20 – 30 mm (3/4 – 1/4 in)

Tires

Tire size		Front	Rear
		3.50S 19-4PR	130/90-16 67S
Cold tire pressures kPa (kg/cm ² , psi)	Up to 90 kg (200 lbs) load	200 (2.0, 28)	200 (2.0, 28)
	90 kg (200 lbs) load to vehicle capacity load	200 (2.0, 28)	250 (2.5, 36)
Tire brand	BRIDGESTONE	L303	S714
	DUNLOP	F11	K127

Suspension air pressure: Front: 80 – 120 kPa (0.8 – 1.2 kg/cm², 11 – 17 psi)
 Rear: GL500: 0 – 500 kPa (0 – 5.0 kg/cm², 0 – 70 psi)
 GL500I: 100 – 500 kPa (1.0 – 5.0 kg/cm², 14 – 70 psi)



MAINTENANCE SCHEDULE

Perform the PRE-RIDE INSPECTION in the Owner's Manual at each scheduled maintenance period.

I: INSPECT AND CLEAN, ADJUST, LUBRICATE, OR REPLACE IF NECESSARY.

C: CLEAN

R: REPLACE

A: ADJUST

L: LUBRICATE

ITEM	FREQUENCY	WHICHEVER OCCURS FIRST	ODOMETER READING NOTE (3)							REFER TO PAGE
			500 mi (1,000 km)	3,750 mi (6,000 km)	7,500 mi (12,000 km)	11,250 mi (18,000 km)	15,000 mi (24,000 km)	18,750 mi (30,000 km)	22,500 mi (36,000 km)	
* FUEL LINES		EVERY			I		I		I	3-4
* THROTTLE OPERATION			I		I		I		I	3-4
* CARBURETOR-CHOKE					I		I		I	3-5
AIR CLEANER	NOTE (1)				I		I		I	3-5
CRANKCASE BREATHER	NOTE (2)		C		R		C		R	3-5
SPARK PLUGS			R		R		C		C	3-6
* VALVE CLEARANCE					I		R		R	3-7
ENGINE OIL	YEAR		R				I			3-7
ENGINE OIL FILTER	YEAR		R		R		R		R	2-2
* CAM CHAIN TENSION			A		A		A		A	2-2
* CARBURETOR-SYNCHRONIZE					I		I		I	3-9
* CARBURETOR-IDLE SPEED					I		I		I	3-9
RADIATOR COOLANT					I		I		*R	3-10
* RADIATOR CORE					I		I		I	3-10
* COOLING SYSTEM, HOSES					I		I		I	3-10
* DRIVE SHAFT JOINT					L		L		L	2-3
FINAL DRIVE LUBRICANT					I		I		R	2-3
BATTERY	MONTH		I		I		I		I	3-11
BRAKE FLUID (FRONT)	MONTH I 2 YEARS R				I		I		*R	3-11
BRAKE SHOE/PAD WEAR					I		I		I	3-12
BRAKE SYSTEM (REAR)					I		I		I	3-12
* BRAKE LIGHT SWITCH					I		I		I	3-13
* HEADLIGHT AIM					I		I		I	3-13
CLUTCH					I		I		I	3-14
SIDE STAND					I		I		I	3-14
* SUSPENSION					I		I		I	3-14
* NUTS, BOLTS, FASTENERS					I		I		I	3-15
** WHEELS					I		I		I	3-16
** STEERING HEAD BEARING					I		I		I	3-16

* SHOULD BE SERVICED BY AN AUTHORIZED HONDA DEALER, UNLESS THE OWNER HAS PROPER TOOLS AND SERVICE DATA AND IS MECHANICALLY QUALIFIED.

** IN THE INTEREST OF SAFETY, WE RECOMMEND THESE ITEMS BE SERVICED ONLY BY AN AUTHORIZED HONDA DEALER.

NOTES: (1) SERVICE MORE FREQUENTLY WHEN RIDING IN DUSTY AREAS.

(2) SERVICE MORE FREQUENTLY WHEN RIDING IN RAIN OR AT FULL THROTTLE, OR AFTER BEING WASHED OR DROPPED ON ITS SIDE.

(3) FOR HIGHER ODOMETER READINGS, REPEAT AT THE FREQUENCY INTERVAL ESTABLISHED HERE.

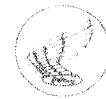

FUEL LINES

Make sure that the fuel lines and connections are not deteriorated, damaged or leaking.
Replace any parts which have signs of deterioration, damage or leakage.

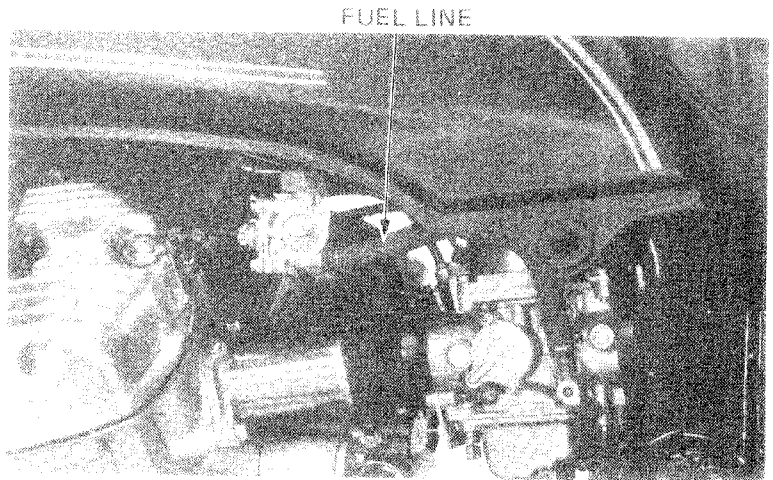

THROTTLE OPERATION

NOTE

The accelerator pump may flood the carburetors during this inspection.

Check that there is no deterioration, damage, or kinks in the throttle cables, and that the throttle grip free play is 2–6 mm (1/8–1/4 in) on the outer edge of the throttle grip flange.

Check for smooth throttle grip rotation from fully closed to fully open positions at all steering positions.

Lubricate the cables if they are not smooth.

Check that the throttle grip automatically returns from fully open to fully closed position when released.

Adjust or replace, if necessary.

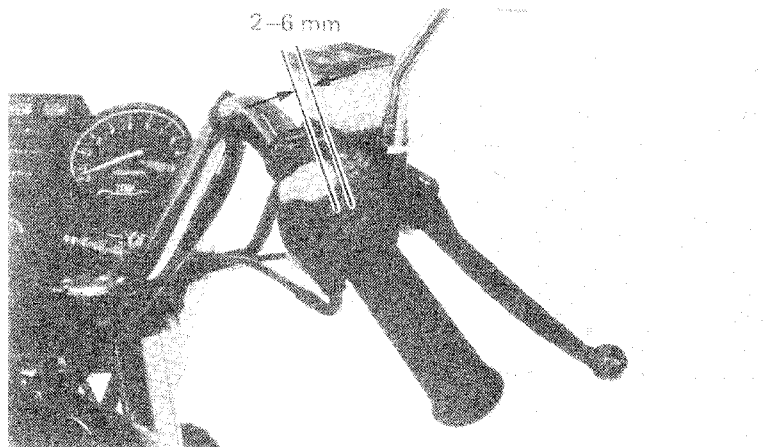

Throttle grip free play can be adjusted at either end of the throttle PULL cable. Major adjustments must be made at the lower adjuster on the carburetor, after removing the fuel tank. Adjust by loosening the adjuster lock nut and turning the adjuster. Tighten the lock nut. Minor adjustments must be made at the upper adjuster.

Install the fuel tank.

Recheck throttle operation.

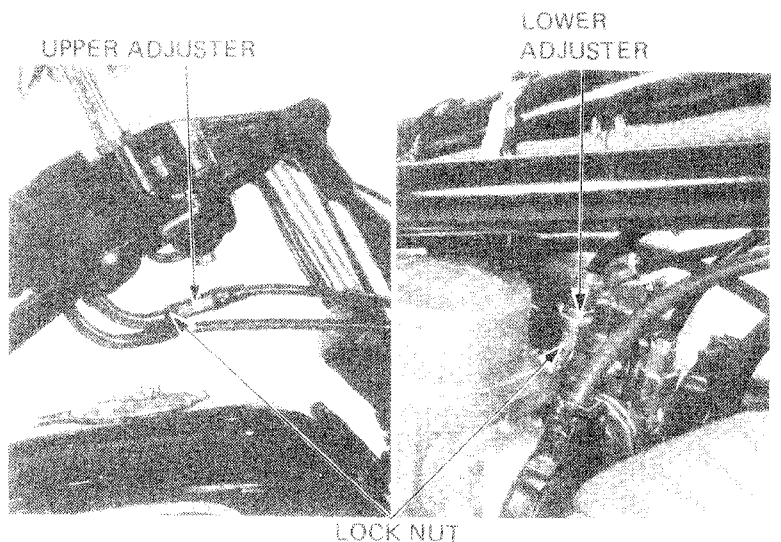



CARBURETOR CHOKE

Operate the choke knob and check for smooth operation.

Pull the choke knob up all the way to fully closed. Make sure that the choke valve is fully closed at the carburetors by moving the lever.

To adjust, remove the fuel tank. Loosen the choke cable clamp and move the choke cable casing until the lever is fully closed.

Tighten the clamp, holding the choke lever fully closed.

Push the choke knob down all the way to fully open.

Make sure the choke valve is fully open by checking for free play in the cable between the lever and cable casing.

Install the fuel tank.

Adjust the choke operating friction by turning the friction adjuster if necessary.

The choke knob must move smoothly and stay where positioned.

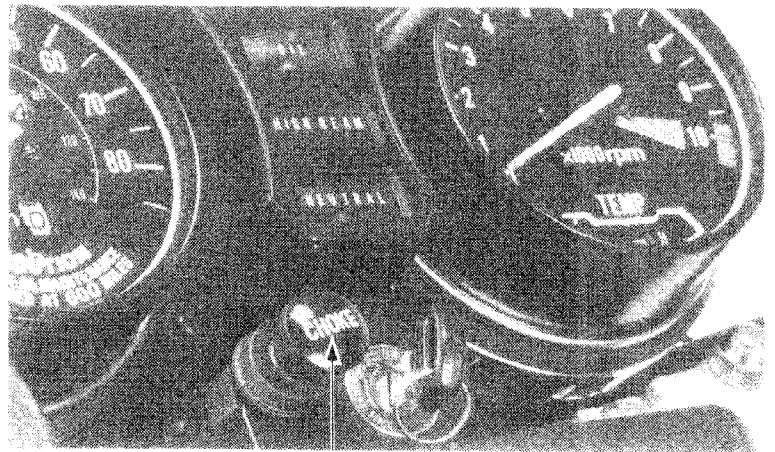

CHOKE KNOB

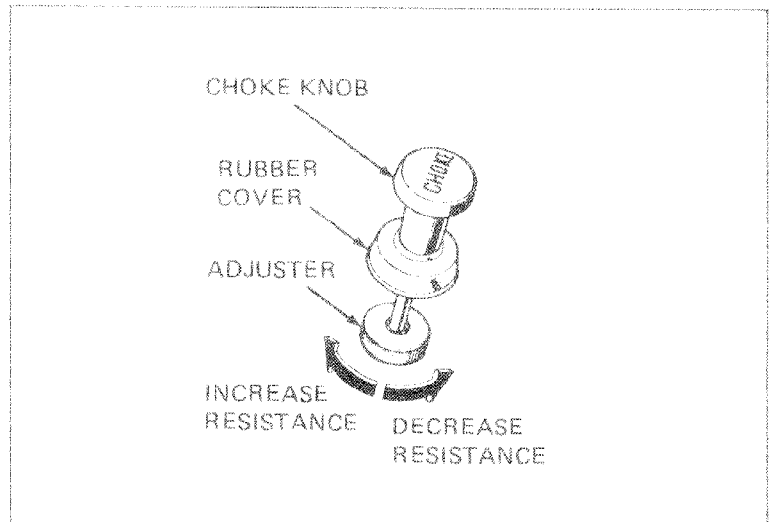

AIR CLEANER

Remove the right side cover.

Remove the air cleaner cover by turning it counter-clockwise.

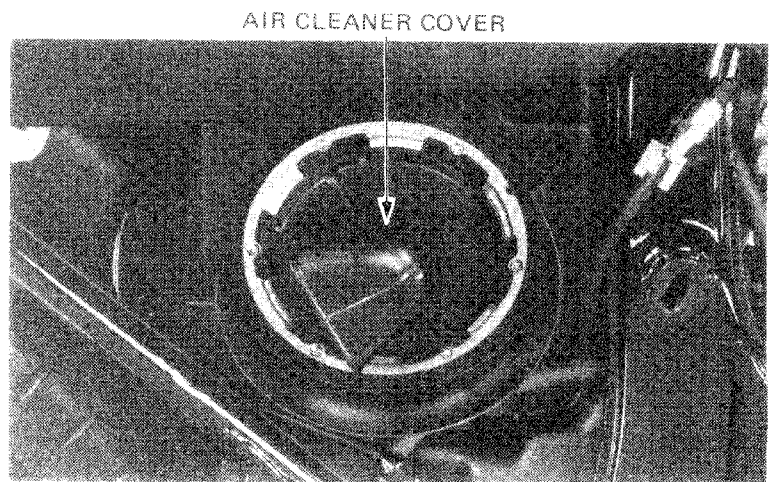

AIR CLEANER COVER

Remove the air cleaner element.

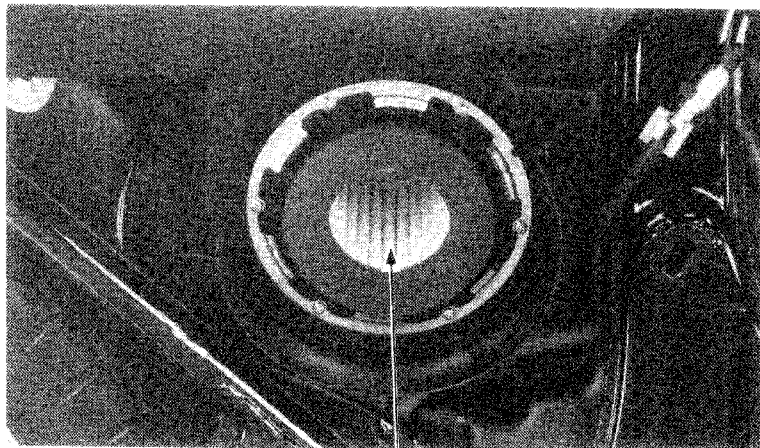

AIR CLEANER ELEMENT

Clean the air cleaner element by tapping it lightly to loosen dust.

Blow away remaining dust by compressed air from the outside of the element.

Replace the element if it is excessively dirty, torn or damaged.

NOTE

Install the cover with the "TOP" mark facing upward.

Install element and cover. Install the right side cover.

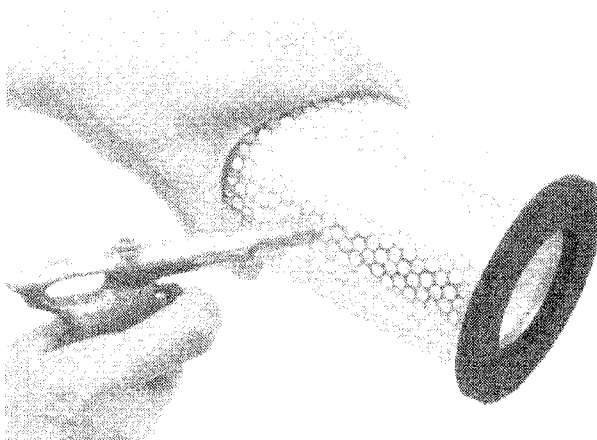

CRANKCASE BREATHER

Remove the plug from the drain tube to drain deposits.

Install the drain plug.

NOTE

Service more frequently when ridden in rain, or at full throttle or if the deposit level can be seen in the transparent section of the drain tubes.

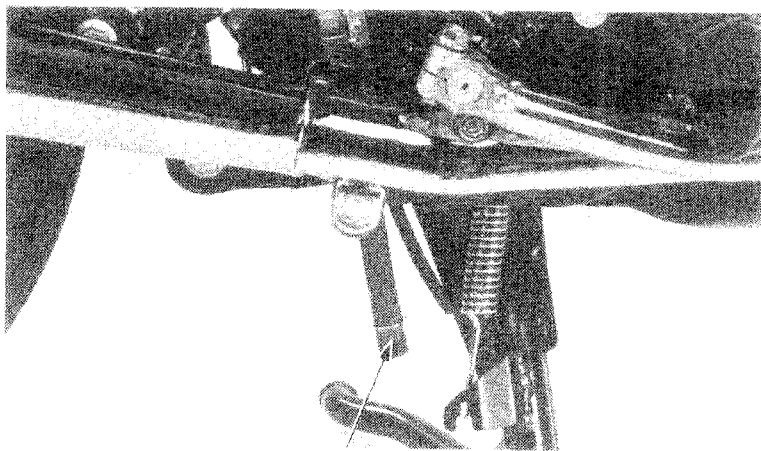

DRAIN PLUG



SPARK PLUGS

RECOMMENDED SPARK PLUG

	GL500, GL500I		For optional radio	
	Standard	For extended high speed riding	Standard	For extended high speed riding
NGK	D8EA	D9EA	DR8ES-L	DR8ES
ND	X24ES-U	X27ES-U	X24ESR-U	X27ESR-U

Clean any dirt from around the spark plug base.
Disconnect the spark plug caps.
Remove and discard the spark plugs.
Measure the new spark plug gaps using a wire-type feeler gauge.

SPARK PLUG GAP:

0.6 – 0.7 mm (0.024 – 0.028 in)

Adjust by bending the side electrode carefully.
With the plug washer attached, thread the spark plugs in by hand to prevent cross-threading.
Tighten the spark plugs another 1/2 turn with a spark plug wrench to compress the plug washer.
Connect the spark plug caps.

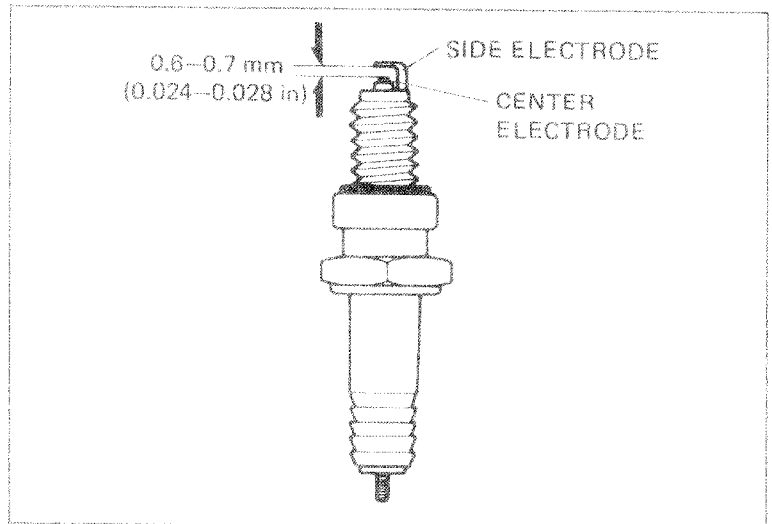

VALVE CLEARANCE

NOTE

This inspection and adjustment must be performed while the engine is cold (below 35°C).

Remove the radiator cover.
Remove the crankshaft hole cap from the transmission cover and the timing inspection hole cap from the rear cover.
Remove the spark plug caps.
Remove the cylinder head covers.

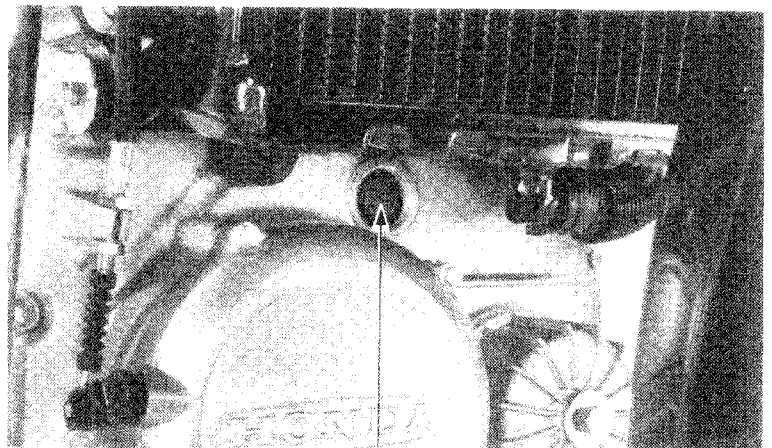

CRANKSHAFT



MAINTENANCE

Turn the crankshaft clockwise and align the "TL" mark on the rotor with the index mark. The left cylinder must be at T.D.C. of the compression stroke.

Check the intake and exhaust valve clearance of the left cylinder by inserting a feeler gauge between the clearance adjusting screw and valve stem.

VALVE CLEARANCE

- IN : 0.08 mm (0.003 in)
- EX : 0.10 mm (0.004 in)

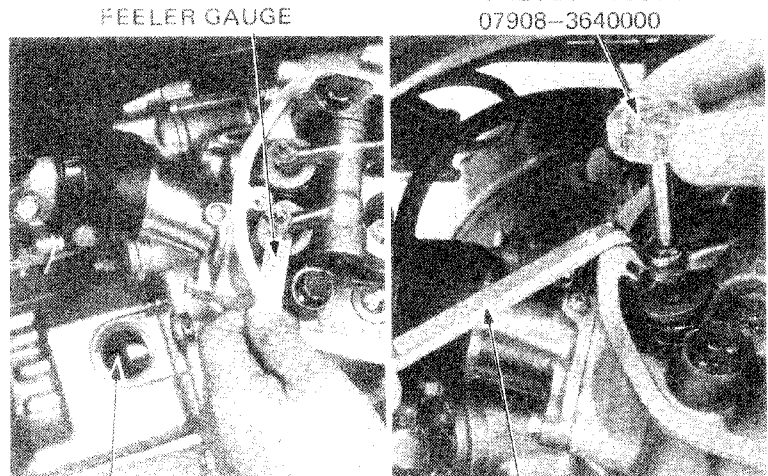

FEELER GAUGE

VALVE ADJUSTER
07908-3640000

TIMING INSPECTION HOLE

VALVE ADJUSTING WRENCH 10 x 12 mm

Adjust, by loosening the lock nut, and turning the screw until there is a slight drag on the feeler gauge. Hold the screw and tighten the lock nut. Recheck the valve clearances.

Turn the crankshaft clockwise and align the "TR" mark on the rotor with the index mark. The right cylinder must be at the T.D.C. of the compression stroke.

Check the intake and exhaust valve clearance of the right cylinder as described for the left cylinder.

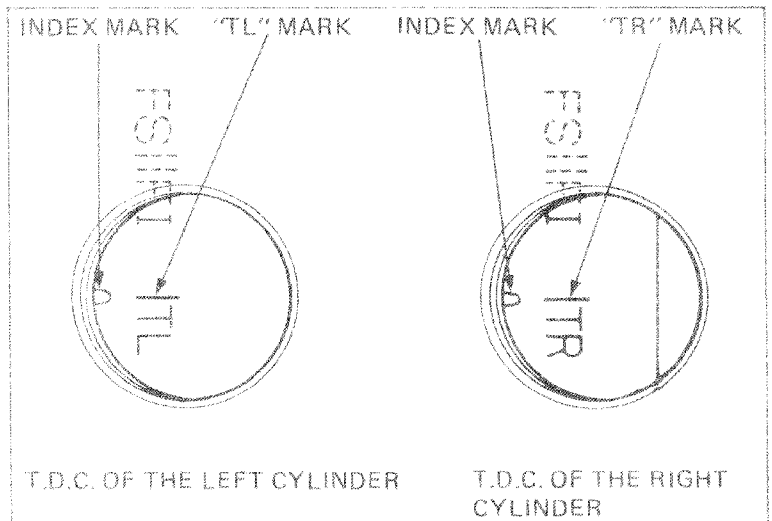

T.D.C. OF THE LEFT CYLINDER

T.D.C. OF THE RIGHT CYLINDER

Install the removed parts in the reverse order of disassembly.

NOTE

Coat the cylinder head cover bolt rubbers with oil before tightening.

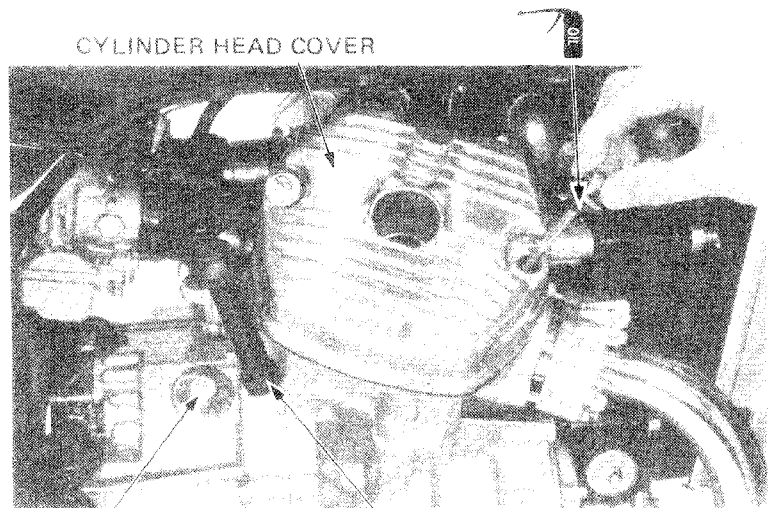

CYLINDER HEAD COVER

TIMING INSPECTION CAP

SPARK PLUG CAP



CAM CHAIN TENSION

Remove the left cylinder head cover.
Remove the crankshaft and timing hole caps from the transmission and rear covers respectively.
Slowly turn the crankshaft clockwise and align the rotor "TL" mark with the index mark. Be sure the left piston is at T.D.C. of the compression stroke.
Loosen the cam chain tensioner lock bolt.
When this bolt is loosened, the cam chain tensioner will automatically position itself to provide the correct cam chain tension.
Retighten the lock bolt.
Install the removed parts in the reverse order of disassembly.

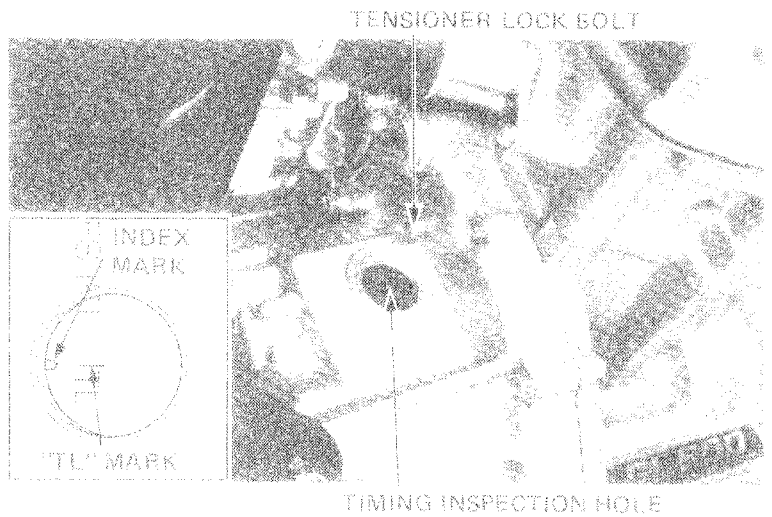

CARBURETOR SYNCHRONIZATION

NOTE

This adjustment is performed with engine at normal operating temperature, transmission in neutral, and vehicle on center stand.

Remove the plugs from the carburetor spacers and install adapters.
Connect the vacuum gauges.

Start the engine and adjust the idle speed to 1,100 \pm 100 rpm.

The difference of vacuum between cylinders should be within 40 mm (1.6 in) Hg.

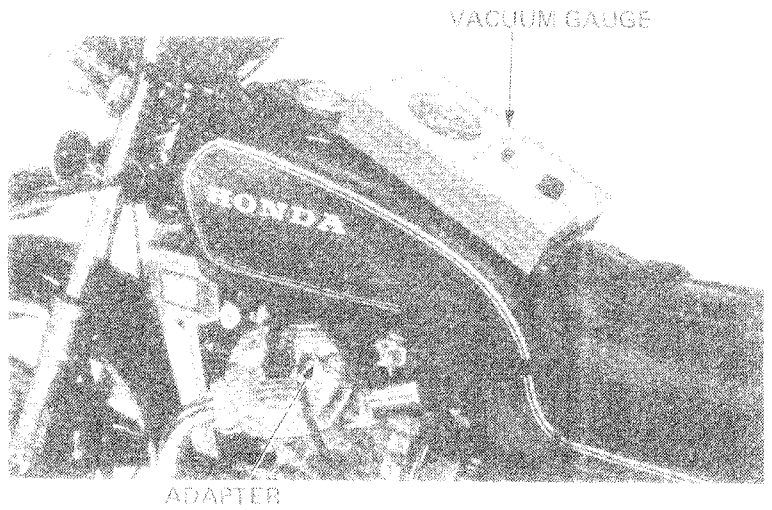

ADJUSTMENT

Prepare a longer fuel tube and connect it to the fuel tank and carburetor.
Position the tank higher than normal.
Loosen adjusting screw lock nut.
Balance the vacuum between cylinders to within 40 mm (1.6 in) Hg of each other, by turning the adjusting screw with tool 07908-4600200.
Hold adjusting screw, and tighten the lock nut.
Recheck the synchronization and idle speed.
Install the carburetor spacer plugs.
Reinstall the fuel tank and seat.

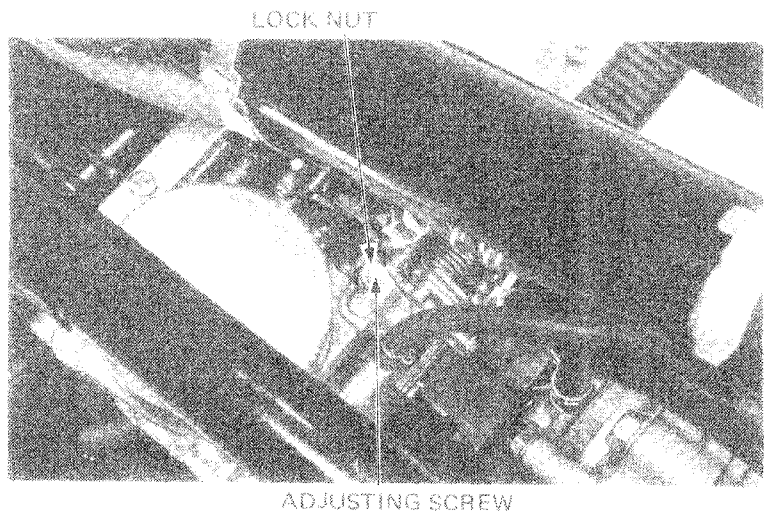



MAINTENANCE

CARBURETOR-IDLE SPEED

NOTE

The engine must be warm for accurate idle adjustment. Ten minutes of stop and go driving is sufficient, or when the temperature gauge needle is in the wide white line.

Warm up the engine, place the transmission in neutral and the motorcycle on its center stand. Adjust idle speed with the throttle stop screw.

IDLE SPEED: 1,100 ± 100 rpm

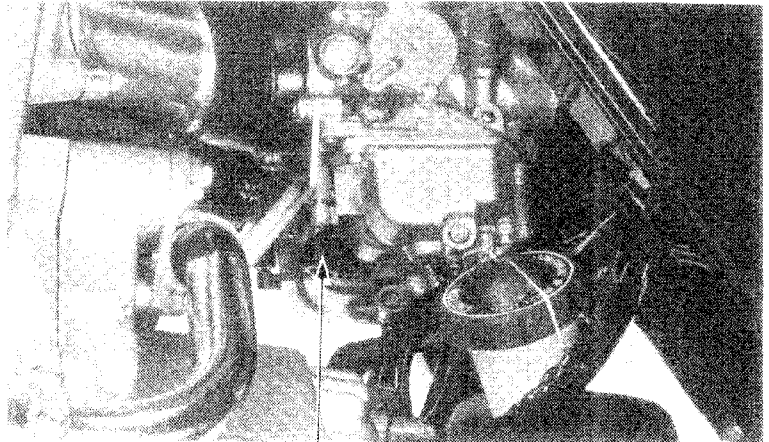

THROTTLE STOP SCREW

RADIATOR COOLANT

Check the coolant level of the reserve tank with the engine running at normal operating temperature.

The level should be between the "FULL" and "LOW" level lines.

If necessary, remove the reserve tank cap and fill to the "FULL" level line.

RESERVE TANK CAP

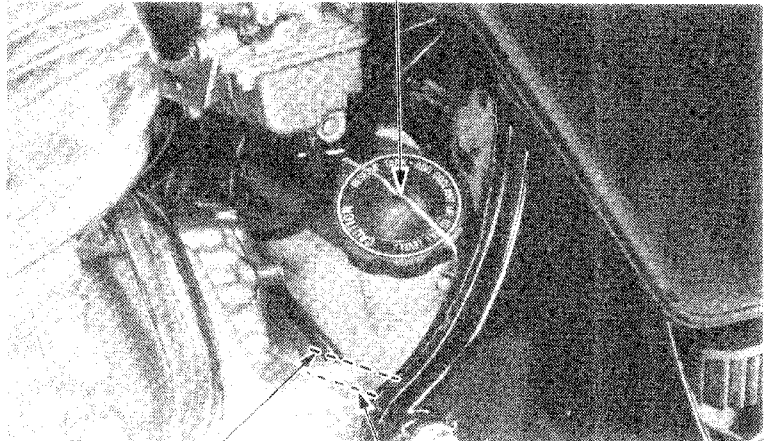

"FULL" MARK

"LOW" MARK

RADIATOR CORE

Check the air passages for clogging or damage.

Straighten bent fins.

Remove insects, mud or any obstruction with compressed air or low water pressure.

Replace the radiator if the air flow is restricted over more than 20% of the radiating surface.

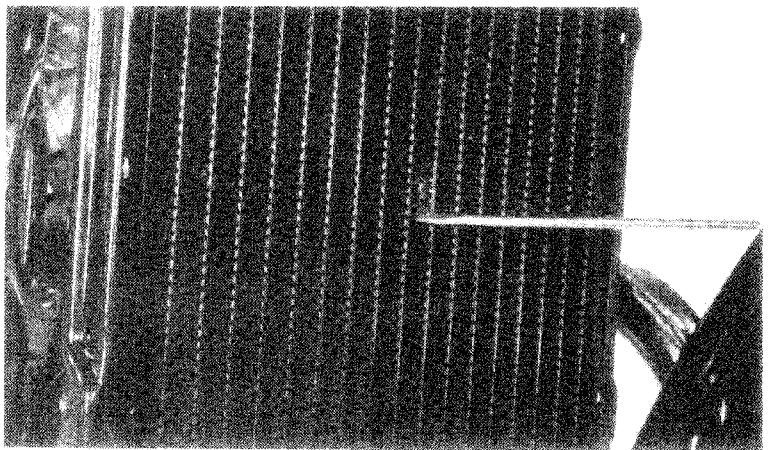



COOLING SYSTEM HOSES

Inspect the hoses for cracks or deterioration, and replace if necessary.
Check the hose clamps, and tighten if necessary.

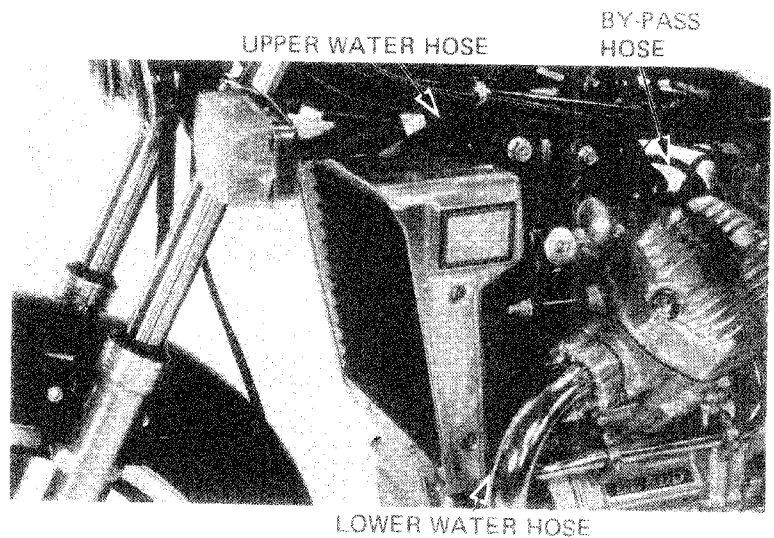

BATTERY

Remove the left side cover.
Inspect the battery electrolyte level.
When the electrolyte level nears the lower level mark, fill with distilled water to the upper level mark.
If sulfation forms on the battery walls or sediments (paste) accumulate on the bottom of the battery, replace the battery.

NOTE

Add only distilled water. Tap water will shorten the service life of the battery.

WARNING

The battery electrolyte contains sulfuric acid. Protect your eyes, skin and clothing. In case of contact, flush thoroughly with water and call a doctor if electrolyte gets in your eyes.

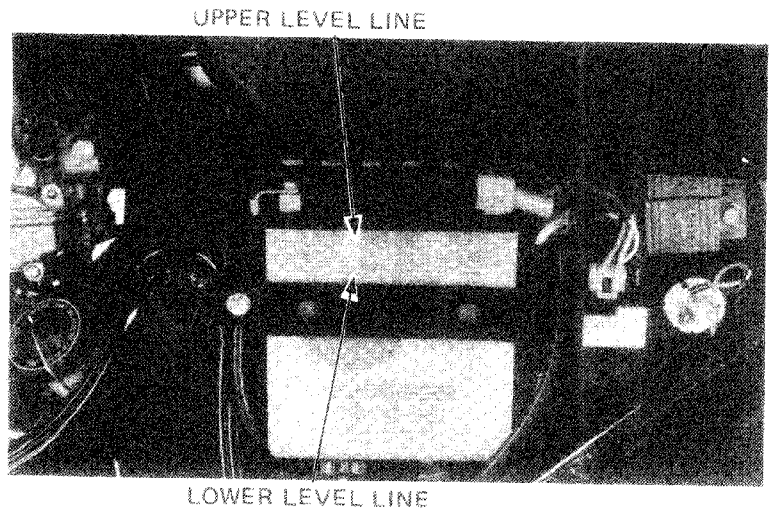

BRAKE FLUID

Check the front brake fluid reservoir level.
If the level nears the lower level mark, fill the reservoir with SAE J1703 or DOT -3 BRAKE FLUID to the upper level mark.
Check the entire system for leaks, if the level is low.

CAUTION

- Do not remove the cover until the handlebar has been tuned so that the reservoir is level.
- Avoid operating the brake lever with the cap removed. Brake fluid will squirt out if the lever is pulled.
- Do not mix different types of fluid, as they are not compatible.

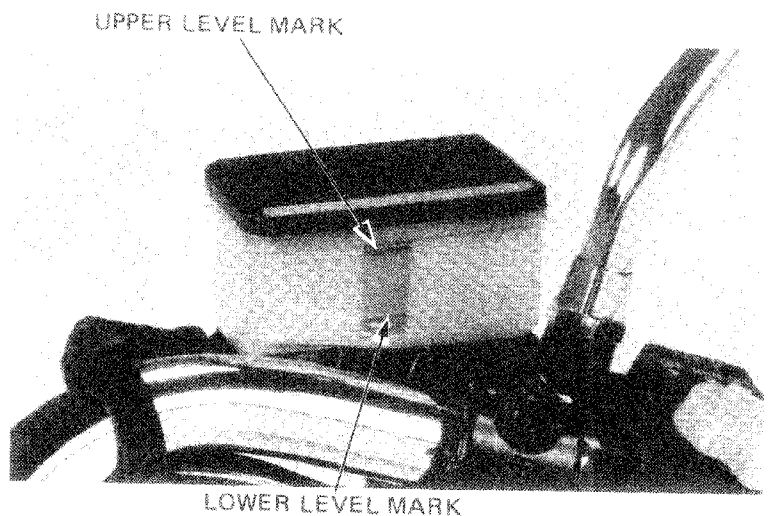



MAINTENANCE

BRAKE SHOE/PAD WEAR

BRAKE PAD WEAR

Check the brake pads for wear by looking through the slot indicated by the arrow cast on the caliper assembly.

Replace the brake pads if the wear line on the pads reaches the edge of the brake disc (Refer to page 15-3).

CAUTION

Always replace the brake pads in pairs to assure even disc pressure.

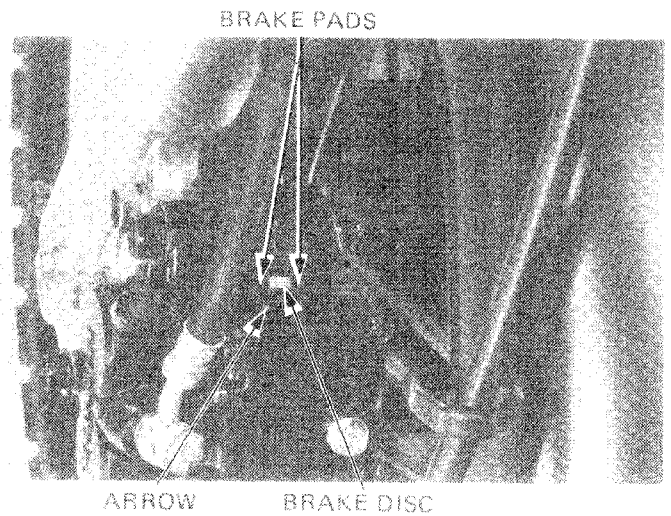

BRAKE SHOE INSPECTION (WEAR INDICATOR)

Replace the brake shoes if the arrow on the brake arm aligns with the reference mark "△" on full application of the rear brake.

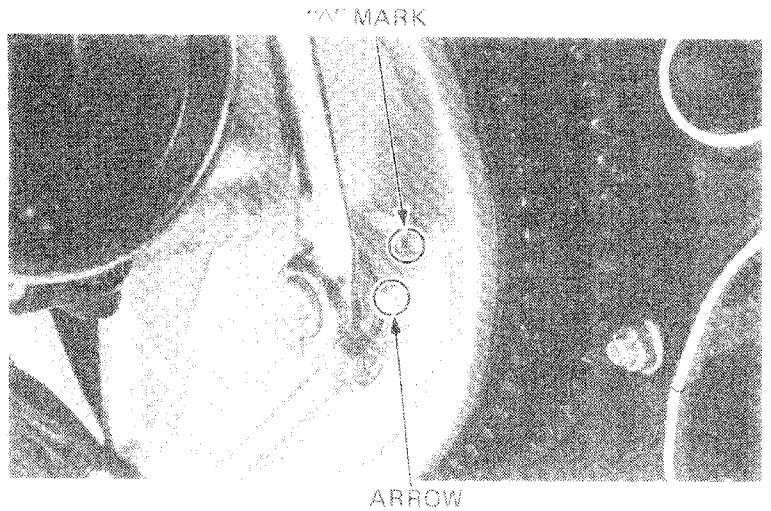

BRAKE SYSTEM

BRAKE SYSTEM HOSE

Make sure that the brake hose is not deteriorated and check the entire brake system for leaks.

BRAKE PEDAL HEIGHT

Loosen the lock nut.
Adjust the brake pedal height by turning the stopper bolt.
Retighten the lock nut.

NOTE

After adjusting the brake pedal height, check the rear brake light switch and adjust if necessary.

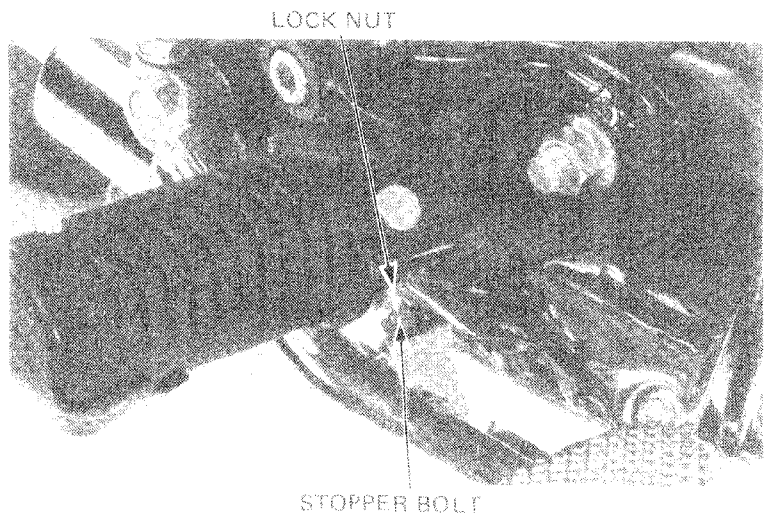



BRAKE PEDAL FREE PLAY

Check the brake pedal free play.

FREE PLAY: 20 – 30 mm (3/4 – 1-1/4 in)

If adjustment is necessary, turn the rear brake adjusting nut.

BRAKE ADJUSTING NUT

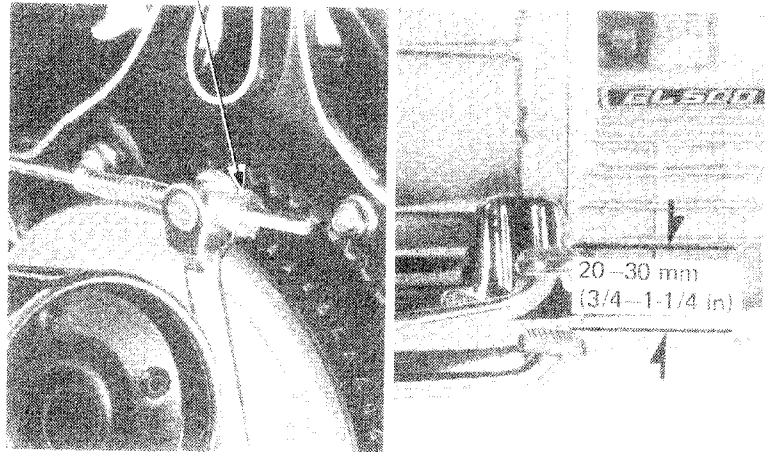

BRAKELIGHT SWITCH

Adjust the brakelight switch so that the brakelight will come on when the brake pedal is depressed 20 mm (3/4 in), when the brake begins engagement. Adjust by turning the switch adjusting nut.

NOTE

- Perform brakelight switch adjustment after adjusting brake pedal play and pedal height.
- Do not turn the switch body.

BRAKE LIGHT SWITCH

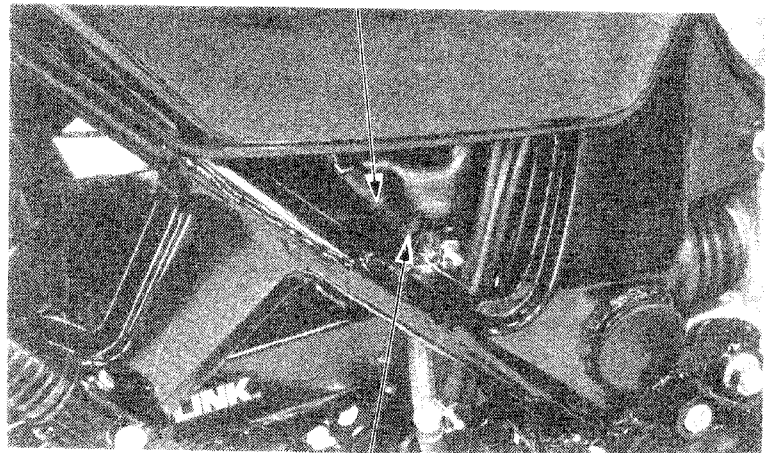

ADJUSTING NUT

HEADLIGHT AIM

Adjust vertically by loosening both headlight case mounting bolts.

Adjust horizontally by turning the adjusting screw on the headlight rim.

Turn the adjusting screw clockwise to direct the beam toward the right side of the rider.

NOTE

Adjust the headlight beam as specified by local laws and regulations.

WARNING

An improperly adjusted headlight may blind oncoming drivers, or it may fail to light the road for a safe distance.

MOUNTING BOLTS

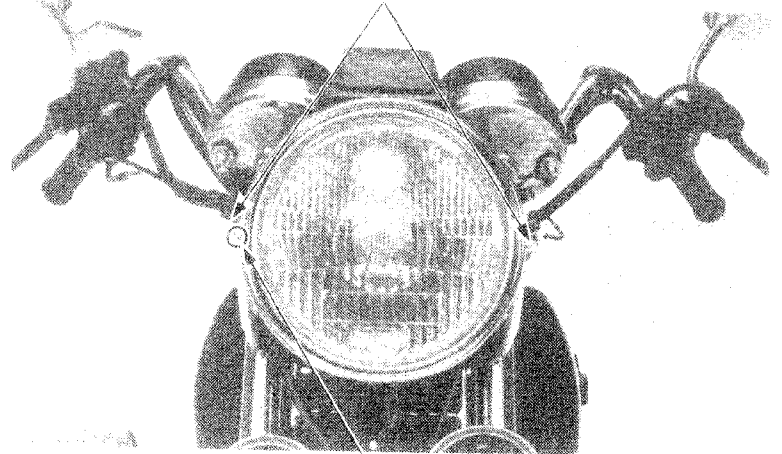

ADJUSTING SCREW



MAINTENANCE

CLUTCH

Inspect the clutch lever free play at the end of the lever.

FREE PLAY: 10 – 20 mm (3/8 – 3/4 in)

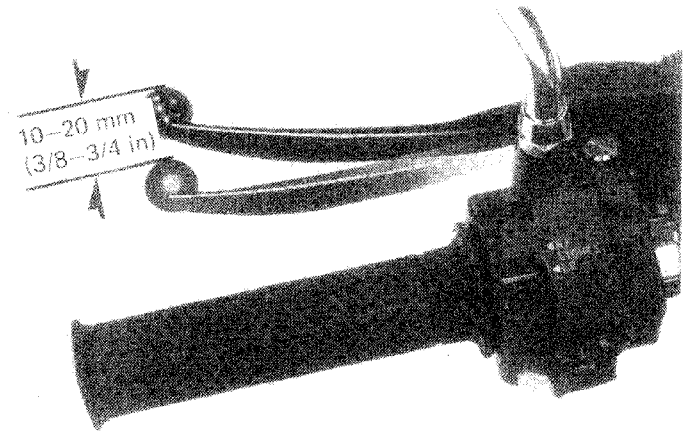

Major adjustments should be made using the adjuster located at the clutch housing. Loosen the lock nut and turn the clutch cable adjuster. Minor adjustments can be made with the clutch cable adjuster located on the clutch lever. Loosen the lock nut and turn the adjuster.

NOTE

Do not allow the threads at the adjuster to come out by more than 8 mm (0.3 in.).

WARNING

Do not burn yourself on the exhaust pipe.

Recheck the clutch operation.

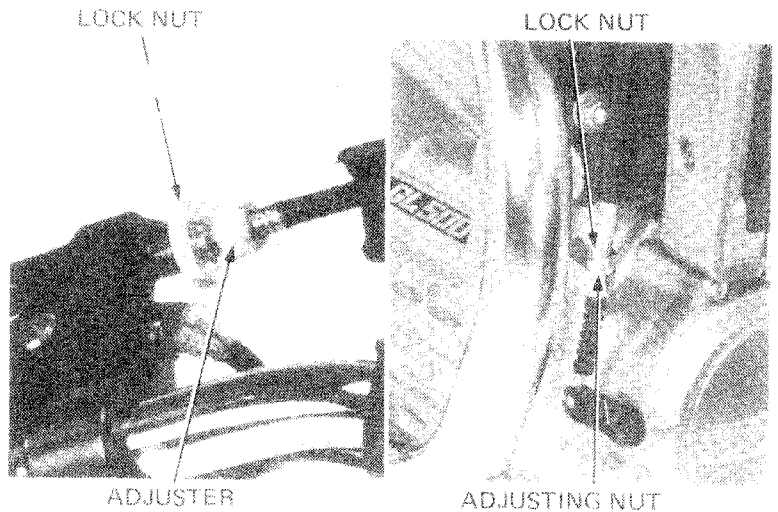

SIDE STAND

Check the rubber pad for deterioration or wear. Replace if any wear extends to wear line as shown. Check the side stand spring for damage and loss of tension, and the side stand assembly for freedom of movement and bend.

NOTE

- When replacing, use a rubber pad with the mark "Over 260 lbs ONLY".
- Spring tension is correct if the measurements fall within 2–3 kg (4.4–6.6 lb), when pulling the side stand lower end with a spring scale.

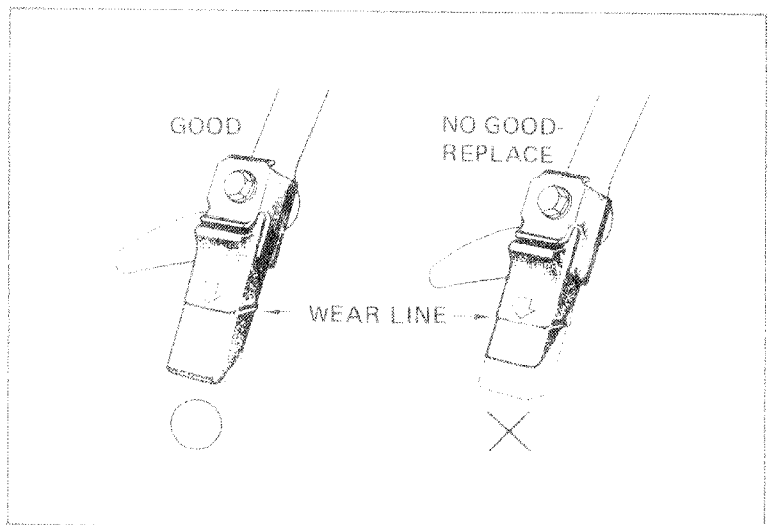



SUSPENSION

WARNING

Do not ride a vehicle with faulty suspension. Loose, worn or damaged suspension parts impair vehicle stability and control.

FRONT

Check the action of the front forks by compressing them several times.

Check the entire fork assembly for leaks or damage. Replace damaged components which cannot be repaired.

Tighten all nuts and bolts.

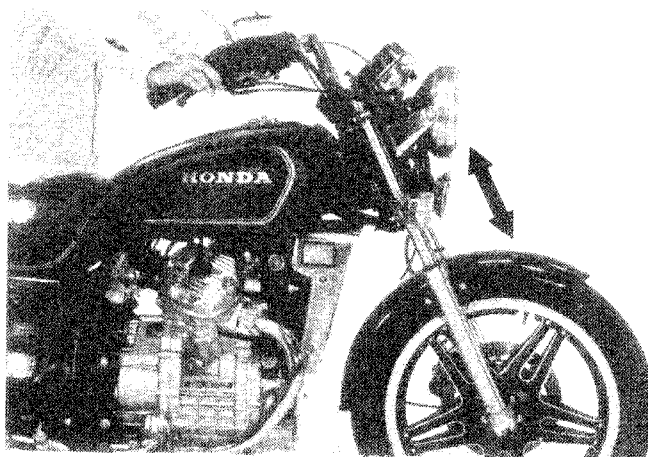

Check the front fork air pressure when the front forks are cold.

Place the vehicle on its center stand.

Remove the valve cap and measure the front fork air pressure.

FRONT FORK AIR PRESSURE:

80 — 120 kPa (0.8 — 1.2 kg/cm², 11 — 17 psi)

VALVE CAP

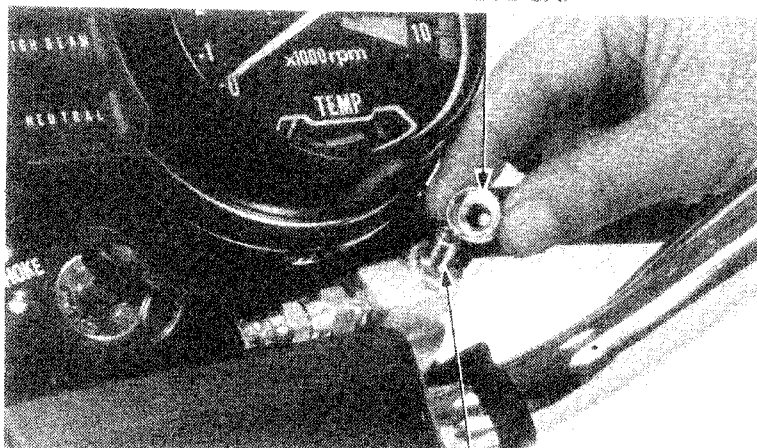

AIR VALVE

REAR

Place the motorcycle on its center stand.

Move the rear wheel sideways with force to see if the swingarm bearings are worn.

Replace if excessively worn (page 14-19).

Check the shock absorber for leaks or damage.

Tighten all rear suspension nuts and bolts.

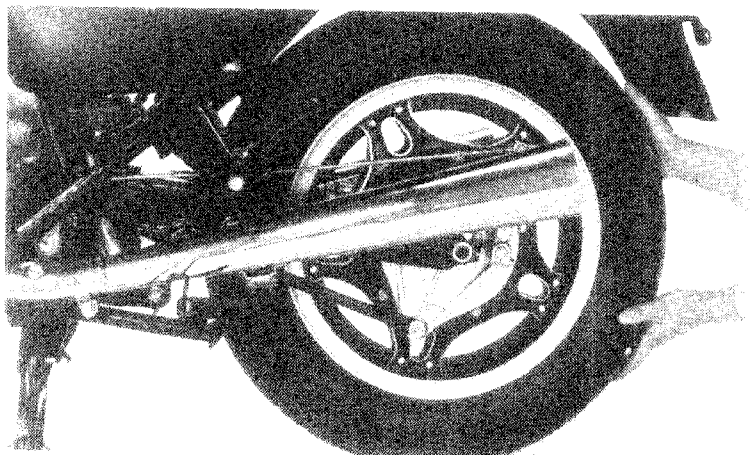

MAINTENANCE

Remove the right side cover.
 Remove the valve cap and measure the rear shock absorber air pressure.

REAR SHOCK ABSORBER AIR PRESSURE:

GL500: 0–500 kPa (0–5.0 kg/cm², 0–70 psi)
 GL500i: 100–500 kPa (1.0–5.0 kg/cm²,
 14–70 psi)

NOTE

Check the air pressure when the rear shock absorber is cold.

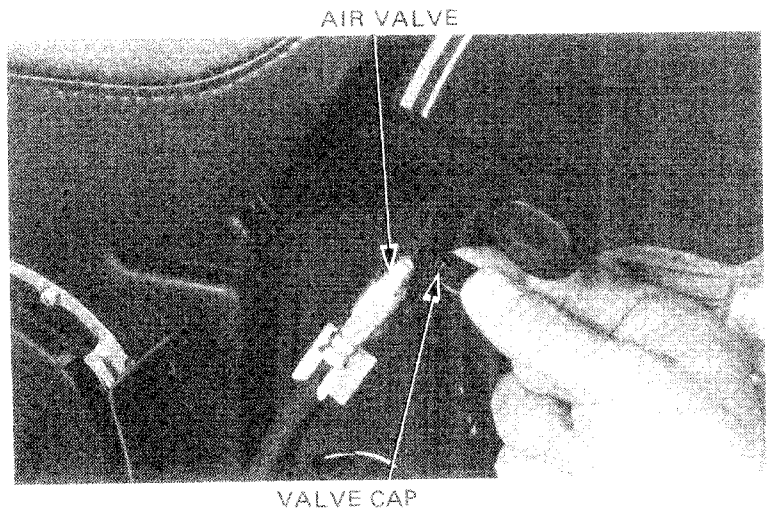
NUTS, BOLTS, FASTENERS

Check that all chassis nuts and bolts are tightened to correct torque values.
 Check all cotter pins and safety clips.

WHEELS
NOTE

Tire pressure should be checked when tires are **COLD**.

Check the tires for cuts, imbedded nails, or other sharp objects.

RECOMMENDED TIRE PRESSURE AND TIRE SIZE:

		Front	Rear
Tire size		3.50S19-4PR	130/90-16-67S
Cold tire pressures kPa (kg/cm ² , psi)	Up to 90 kg (200 lbs) load	200 (2.0, 28)	200 (2.0, 28)
	90 kg (200 lbs) load to vehicle capacity load	200 (2.0, 28)	250 (2.5, 36)
Tire brand	BRIDGE-STONE	L303	S714
	DUNLOP	F11	K127

Check the front and rear wheels for trueness. (page 13-3, 14-5)
 Measure the tread depth at the center of the tires.
 Replace the tires if the tread depth reaches the following limit.

Minimum tread depth:

Front: 1.5 mm (1/16 in)
 Rear: 2.0 mm (3/32 in)

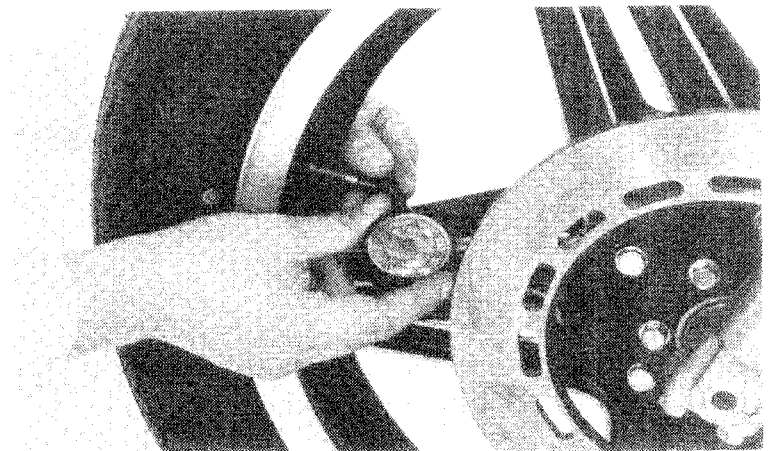



STEERING HEAD BEARINGS

NOTE

Check that the control cables do not interfere with handlebar rotation.

Raise the front wheel off the ground.
Check that the handlebar rotates freely.

If the handlebar moves unevenly, binds, or has vertical movement, adjust the steering head bearing by turning the steering head adjusting nut (page 13-25).

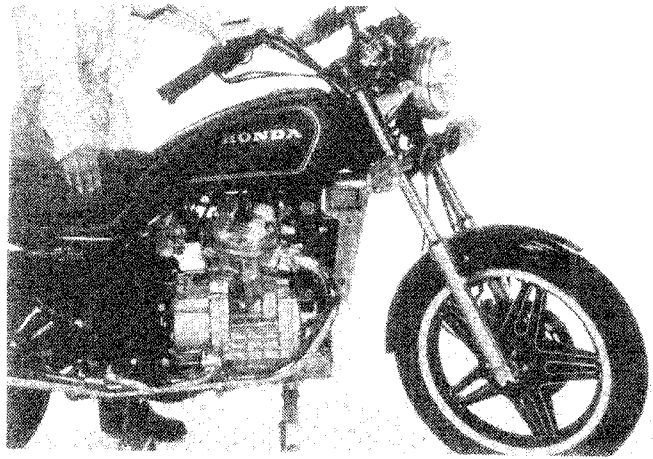

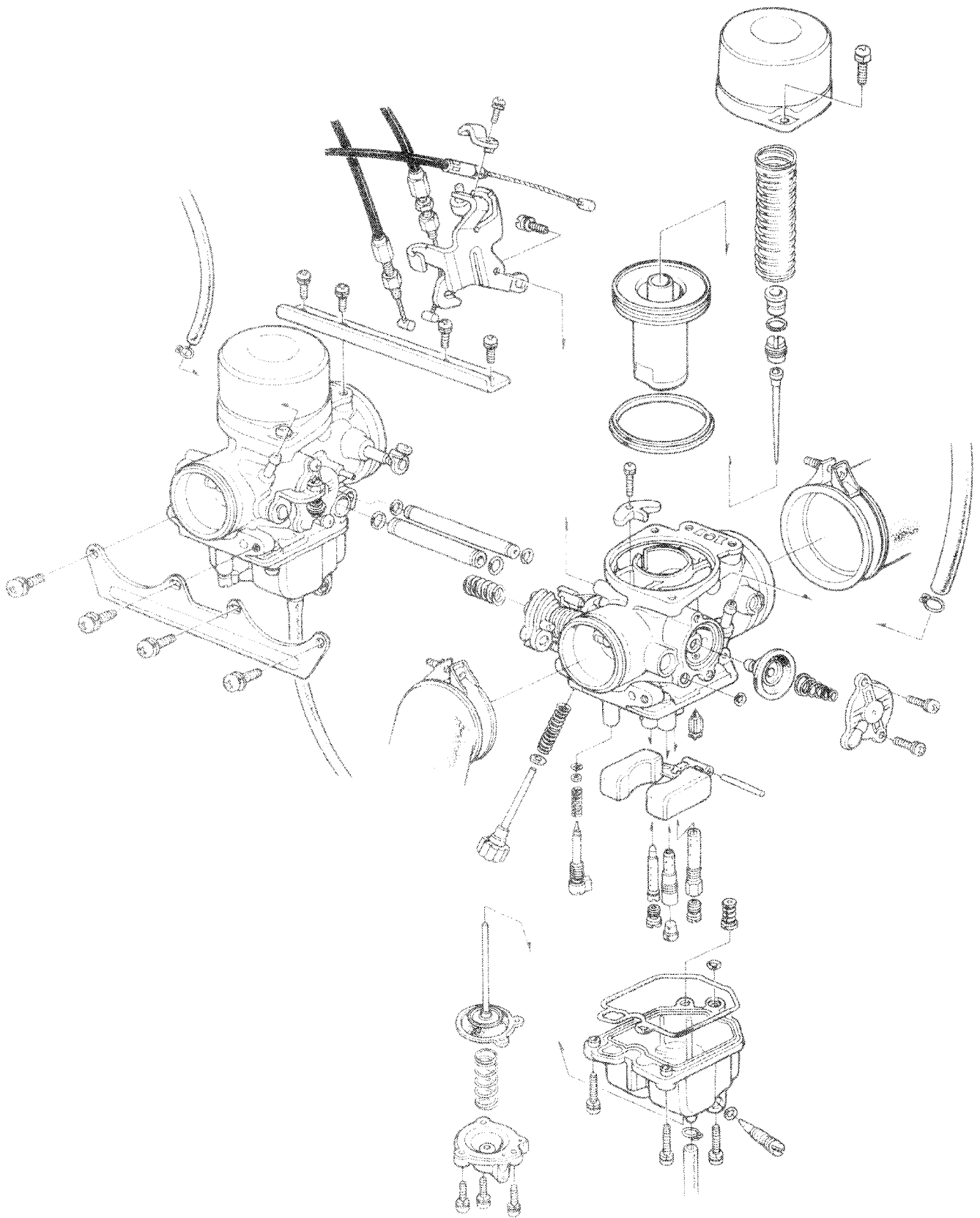



4. FUEL SYSTEM

SERVICE INFORMATION	4-1	ACCELERATOR PUMP DISASSEMBLY	4-9
TROUBLESHOOTING	4-1	COMPONENT ASSEMBLY	4-9
CARBURETOR REMOVAL	4-2	FLOAT LEVEL	4-10
CARBURETOR SEPARATION	4-2	FAST IDLE ADJUSTMENT	4-11
CARBURETOR ASSEMBLY	4-4	ACCELERATOR PUMP ADJUSTMENT	4-11
VACUUM CYLINDER		CARBURETOR INSTALLATION	4-12
DISASSEMBLY/INSPECTION	4-5	PILOT SCREW ADJUSTMENT	4-12
FLOAT CHAMBER DISASSEMBLY	4-6	HIGH ALTITUDE ADJUSTMENT	4-13
AIR CUT-OFF VALVE		FUEL TANK	4-14
DISASSEMBLY	4-8	AIR CLEANER CASE	4-16

SERVICE INFORMATION

GENERAL INSTRUCTIONS

- Use caution when working with gasoline. Always work in a well-ventilated area and away from sparks or open flames.
- When disassembling fuel system parts, note the locations of the O-rings. Replace them with new ones on reassembly.
- The float bowls have drain plugs that can be loosened to drain residual gasoline.

TOOL

Common

- Float level gauge 07401-0010000
- Hand vacuum pump A973X-041-XXXXX (USA only)

SPECIFICATIONS

Venturi diameter	34 mm (1.3 in)
I.D. No.	VB29A
Float level	15.5 mm (0.61 in)
Pilot screw	See Page 4-12
Idle speed	1,100 ± 100 rpm
Vacuum pressure difference between carburetors	40 mm (1.6 in) Hg
Throttle grip free play	2 - 6 mm (1/8 - 1/4 in)

TROUBLESHOOTING

Engine Cranks But Won't Start

1. No fuel in tank
2. No fuel getting to cylinders
3. Too much fuel getting to cylinders
4. No spark at plugs - ignition malfunction
5. Fuel flow restricted

Engine Idles Roughly, Stalls, or Runs Poorly

1. Idle speed incorrect
2. Ignition malfunction
3. Low compression
4. Rich mixture
5. Lean Mixture
6. Air cleaner clogged
7. Air leaking into manifold
8. Fuel flow restricted
9. Fuel contaminated
10. Carburetors not synchronized
11. Faulty vacuum piston

Lean Mixture:

1. Carburetor fuel jets clogged
2. Vacuum piston stuck closed
3. Fuel cap vent blocked
4. Fuel filter clogged
5. Fuel line blocked
6. Float valve faulty
7. Float level too low
8. Fuel flow restricted

Rich Mixture:

1. Choke stuck closed
2. Float level set too high or float sticking
3. Carburetor air jets clogged
4. Sticking float
5. Dirty air cleaner

Fuel flow restricted:

1. Fuel strainer or fuel valve clogged
2. Fuel tank cap breather hole clogged
3. Vacuum tube or air vent tube clogged
4. Fuel valve diaphragm faulty

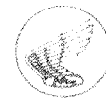

FUEL SYSTEM

CARBURETOR REMOVAL

Remove the fuel tank (page 4-14).
Disconnect the carburetor overflow drain tubes.
Loosen the carburetor band screws.
Remove the carburetor manifolds and remove the carburetor assembly to the left side.

CARBURETOR WIRE BANDS

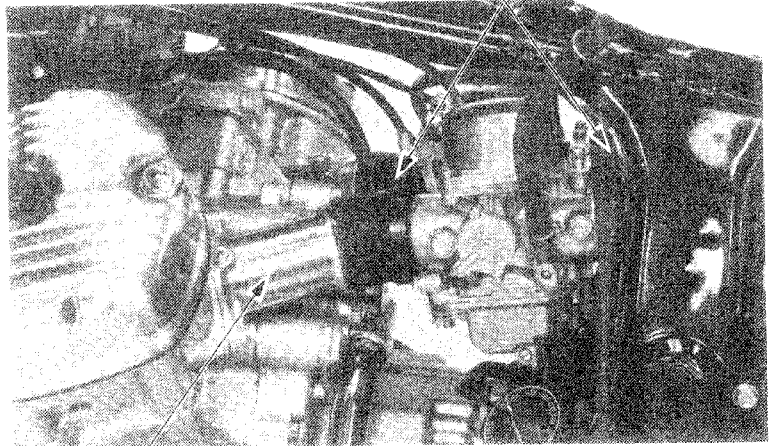

CARBURETOR
MANIFOLD

Loosen the choke cable holder screw and disconnect the choke cable.
Loosen the cable lock nuts and disconnect the throttle cables.
Remove the carburetors.
Disconnect the fuel and vacuum tubes from the carburetor.

THROTTLE CABLES

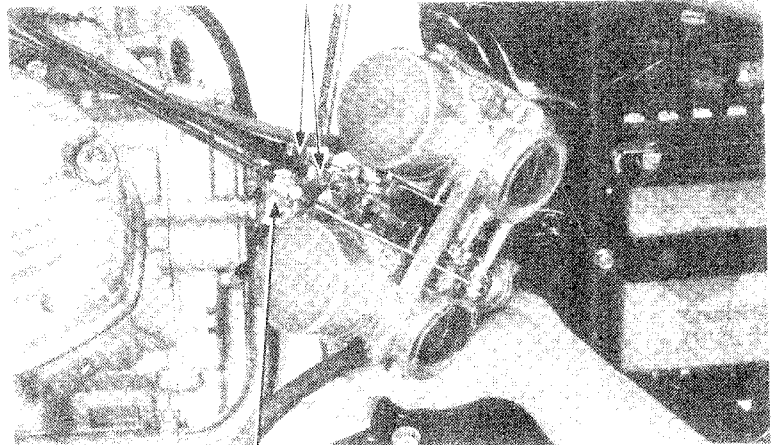

CHOKE CABLE HOLDER

CARBURETOR SEPARATION

CAUTION

The carburetor is pre-set at the factory and pilot screw adjustment is not necessary except after overhauling it.

Remove the choke relief spring.

RELIEF SPRING

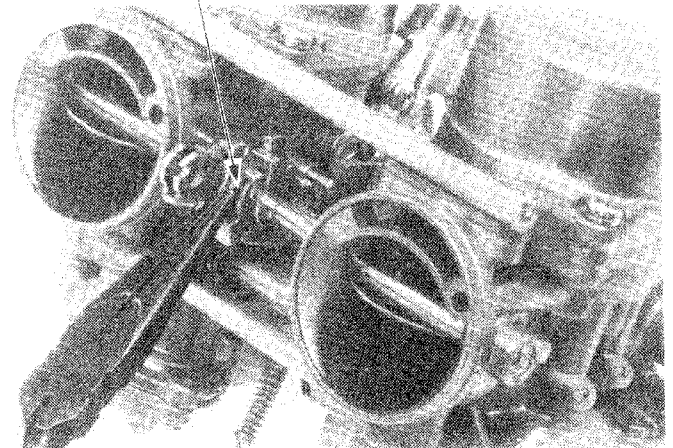

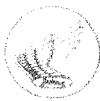

Remove the rear stay.

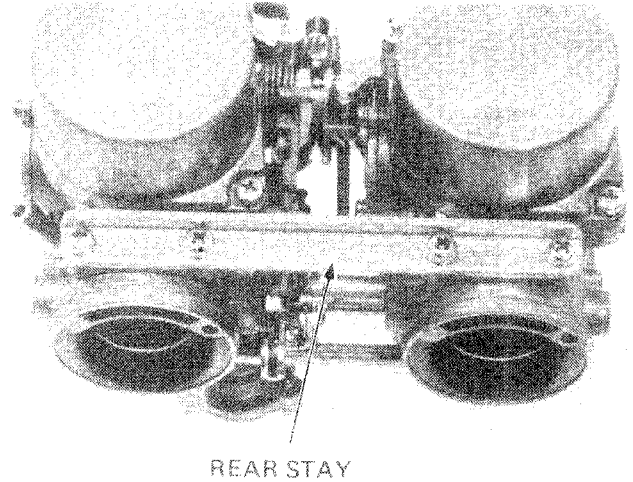

Remove the front stay plate.

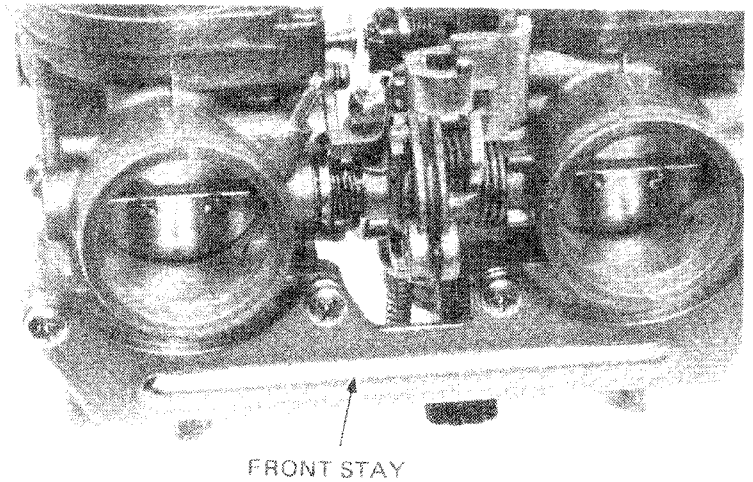

Separate the carburetors.

CAUTION

Separate the carburetors horizontally to prevent damage to the joint pipes and choke linkage.

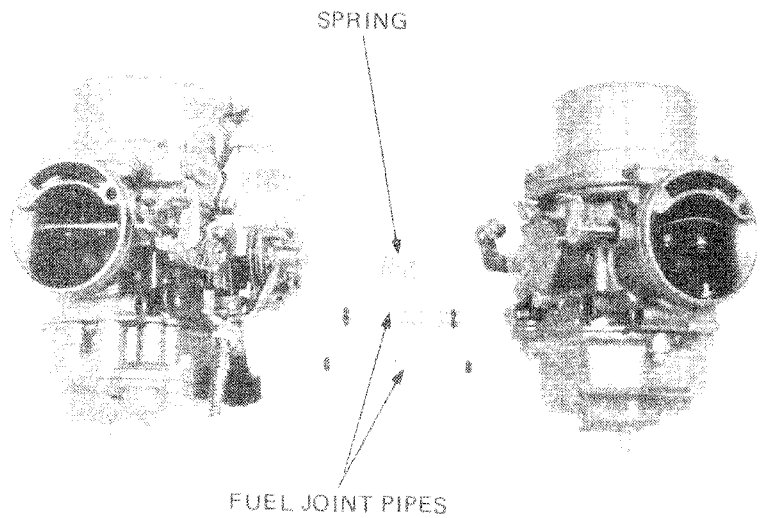



FUEL SYSTEM

CARBURETOR ASSEMBLY

Install new O-rings on the fuel joint pipes.

NOTE

Apply a thin coating of oil to the O-rings.

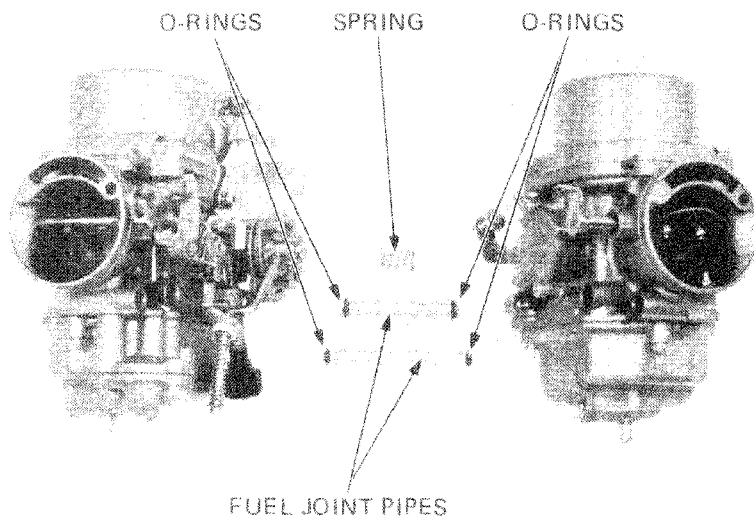

Assemble the right and left carburetors.

NOTE

- Insert the left carburetor throttle link between the plain washers.
- Make sure the spring is properly positioned.

Install the thrust spring between the throttle links.

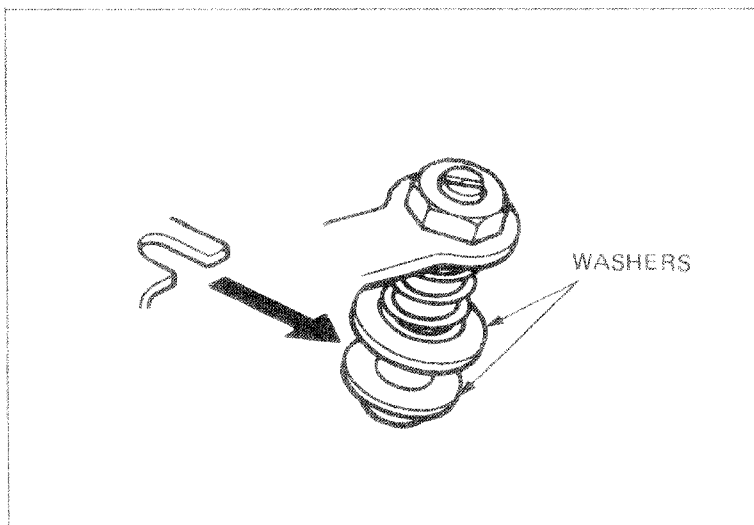

Install the front and rear stay plates.

Hook the relief spring to the choke shaft arm. Close the choke valve and check the choke relief operation.

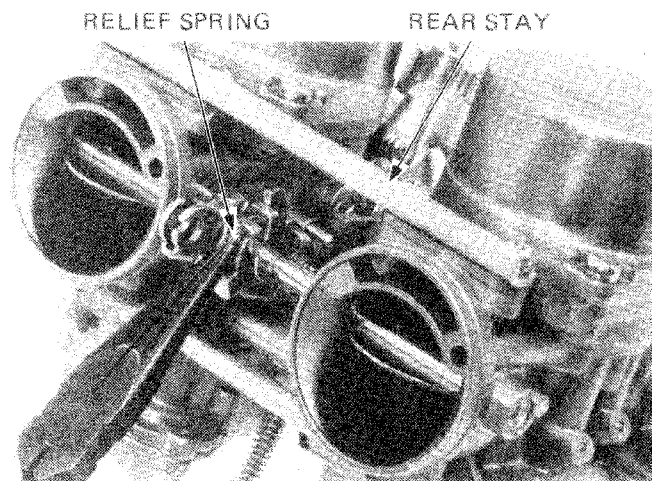



VACUUM CYLINDER DISASSEMBLY/INSPECTION

Remove the vacuum cylinder from the carburetor. Remove the vacuum piston and inspect for wear, nicks, or scratches. Make sure the piston moves freely in the cylinder and in the bore of the carburetor.

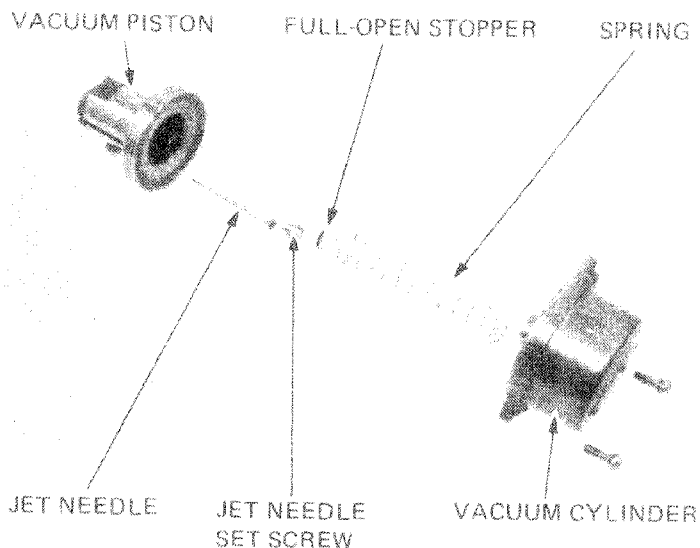

Remove the full-open stopper. Remove the needle set screw and the jet needle.

NOTE

Inspect the needle and seat for deposits, grooves, or other damage.

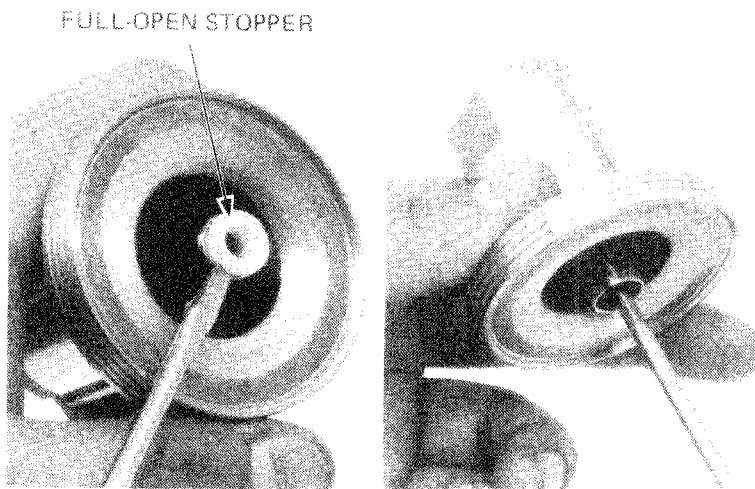

Remove the seal ring and air jet cover.

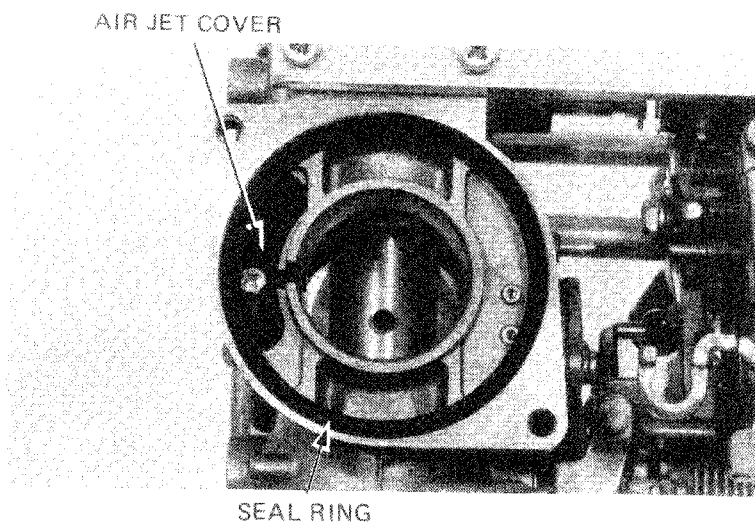



FUEL SYSTEM

Blow open the primary main air jet, secondary air jet, and slow air jet, with compressed air.

NOTE

- Never clean carburetor jets with wire or drills. This will enlarge the openings and result in excessive fuel consumption.
- Do not try to remove the air jets.

SECONDARY AIR JET

SLOW AIR JETS

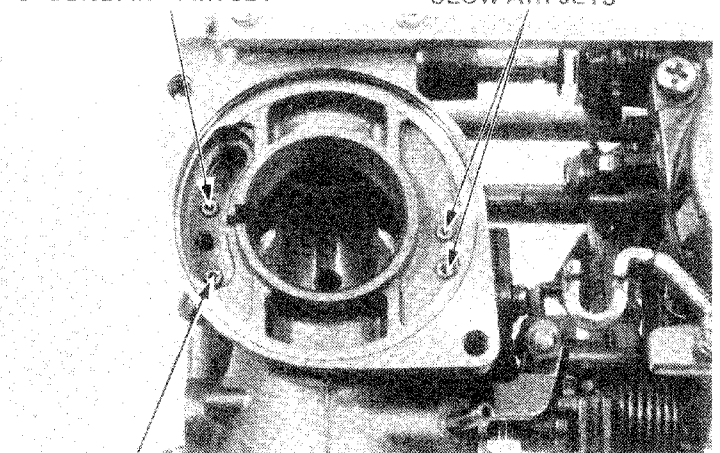

PRIMARY MAIN AIR JETS

VACUUM PISTON INSPECTION

Check the vacuum piston for free movement in the cylinder.

VACUUM PISTON

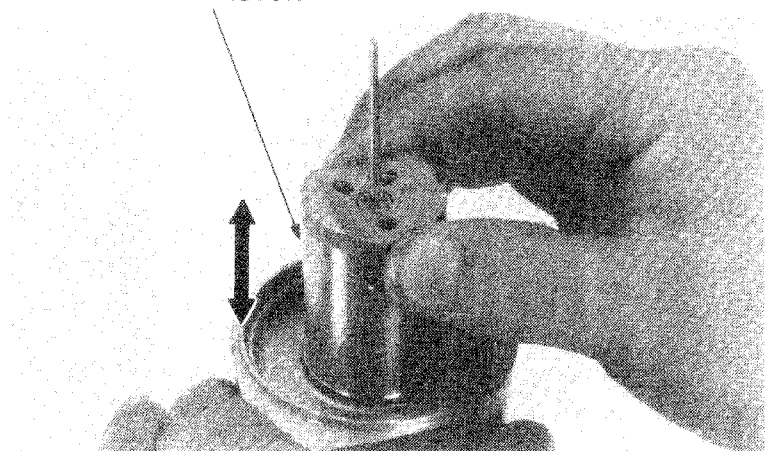

FLOAT CHAMBER DISASSEMBLY

Remove the float chamber body.
 Remove the float arm pin using a needle nose plier.
 Remove the float and float valve.

NOTE

- The pilot screws are factory pre-set and should not be removed unless the carburetor is overhauled.

FLOAT

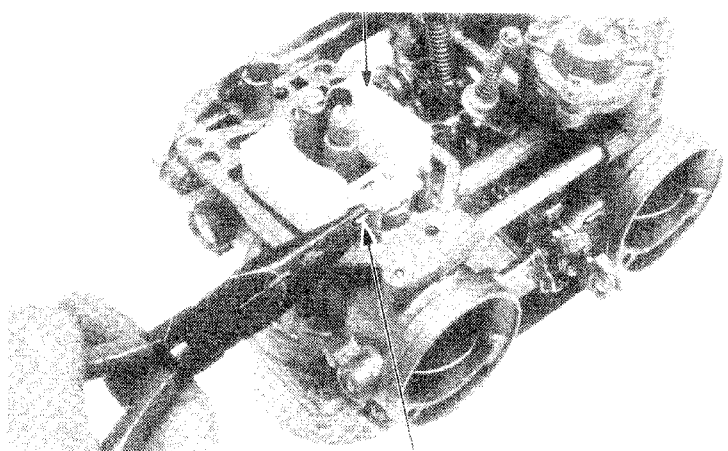

FLOAT ARM PIN



Inspect the float valve and seat for deposits, grooves or other damage.

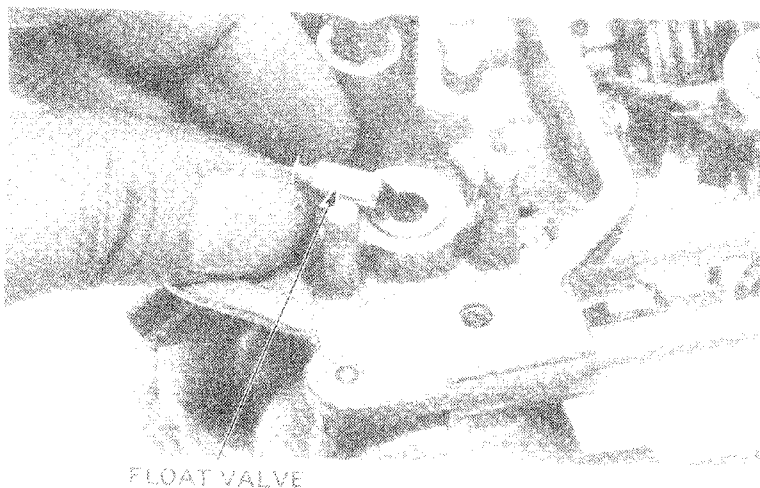

Remove the secondary main jet and jet needle holder.
Remove the primary main jet.
Turn the pilot screw in and carefully count the number of turns before it seats lightly.
Make a note of this to use as a reference when reinstalling the pilot screw.

CAUTION

Damage to the pilot screw seat will occur if the pilot screw is tightened against the seat.

Remove the pilot screw.
Inspect the pilot screw and replace if worn or damaged.

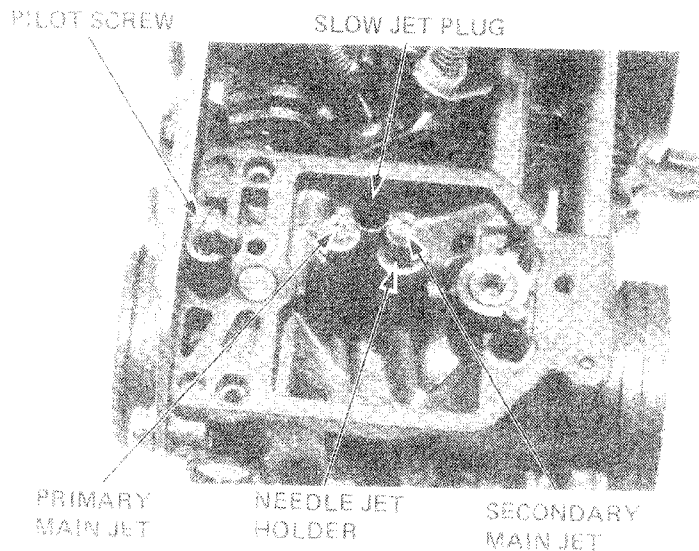

Remove the primary nozzle.
Remove the slow jet.
Tilt the carburetor to remove the needle jet.

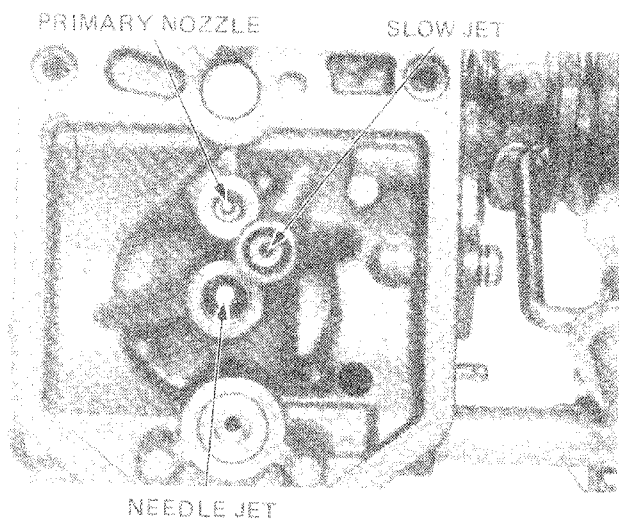

Clean the passages and jets with compressed air.

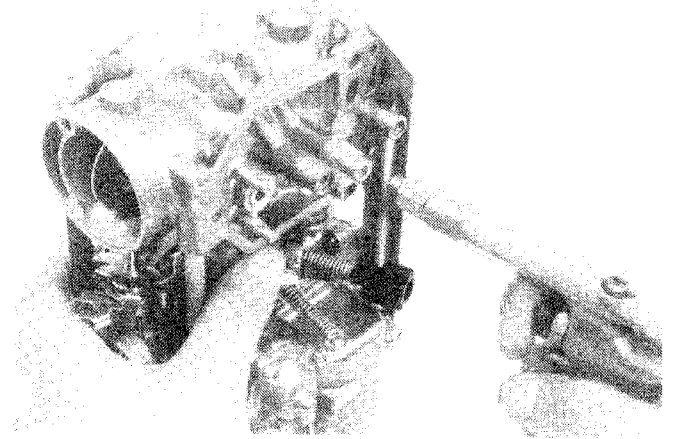

AIR CUT-OFF VALVE DISASSEMBLY

- Remove the air cut-off valve cover and spring.
- Remove the diaphragm.
- Remove the O-ring.

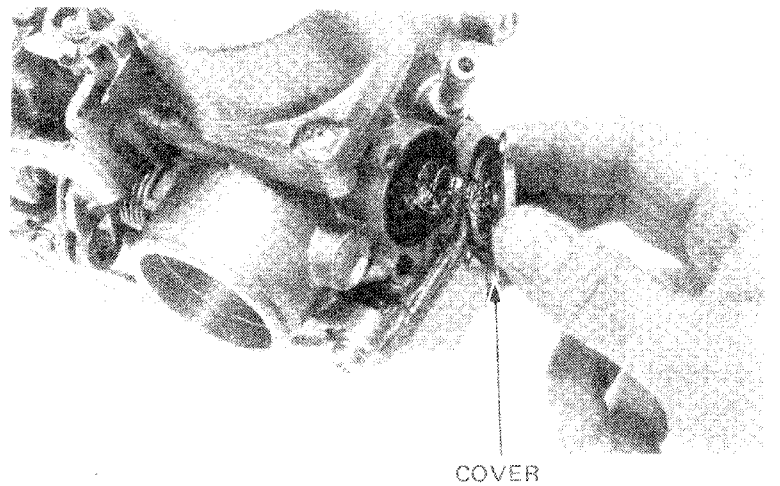

Inspect the air hoses and diaphragm for cracks and brittleness.

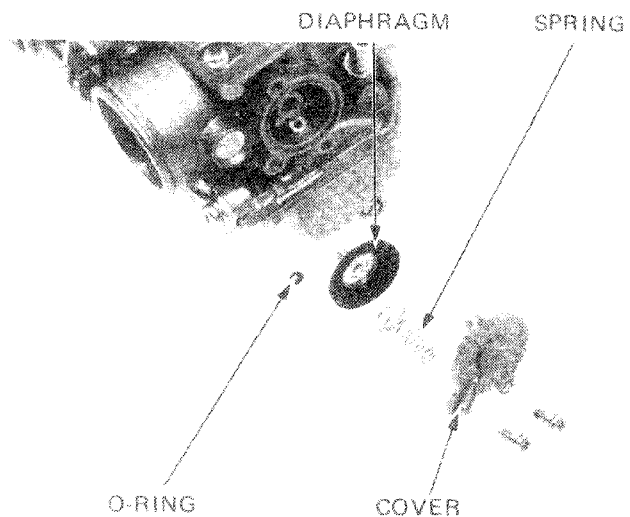



ACCELERATOR PUMP DISASSEMBLY

Remove the accelerator pump cover and spring.

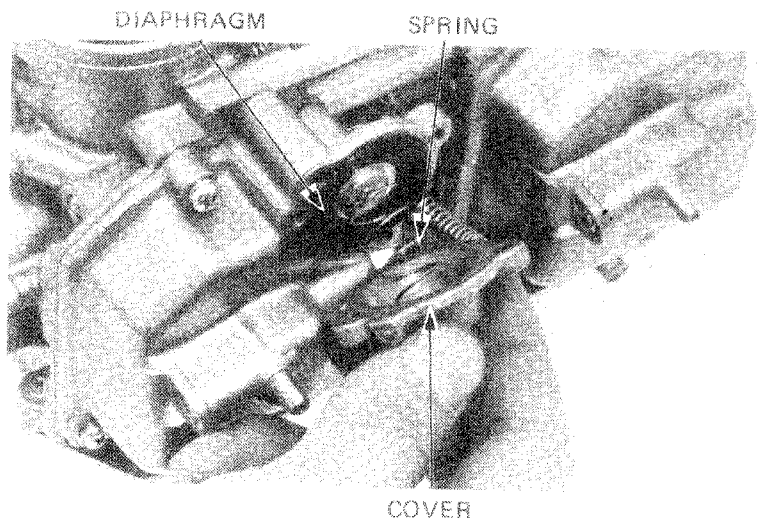

Remove the diaphragm.
Inspect the diaphragm for cracks and brittleness.

NOTE

Be sure the rod is not bent.

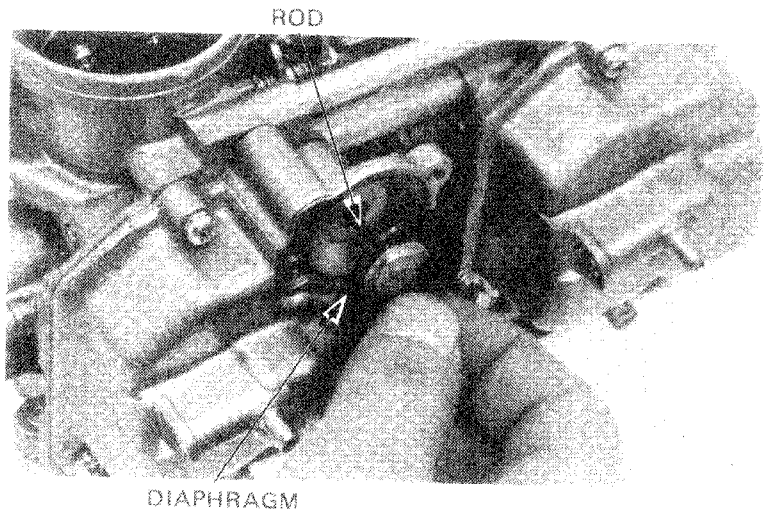

COMPONENT ASSEMBLY

To assemble the accelerator pump, air cut-off valve and vacuum cylinder, reverse the disassembly procedure.

NOTE

When installing the air cut-off valve O-ring, make sure the flat surface is toward the body.

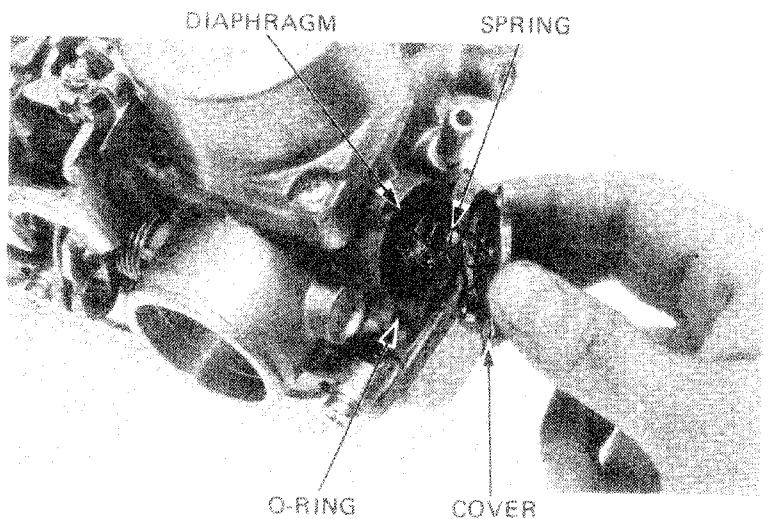



FUEL SYSTEM

Install the jets in the carburetor body.

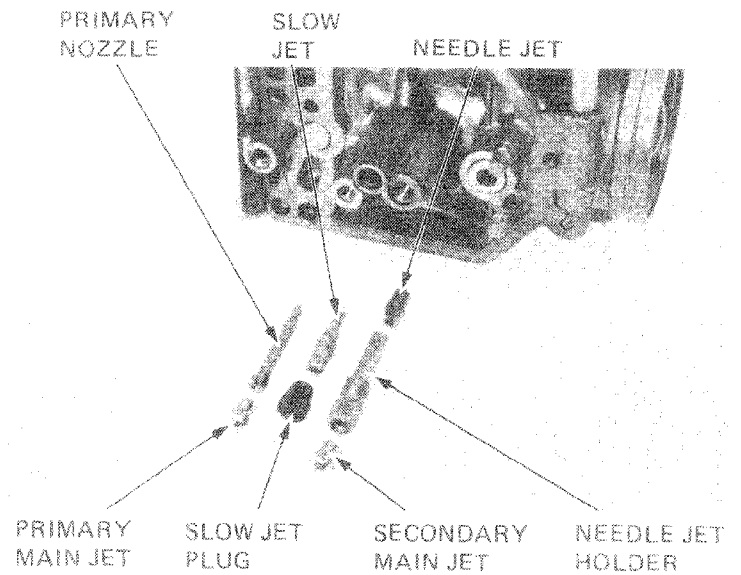

Install the pilot screw and return it to its original position as noted during removal. Perform pilot screw adjustment if a new pilot screw is installed (page 4-12).

NOTE

Do not install limiter caps on new pilot screws until after adjustment has been made.

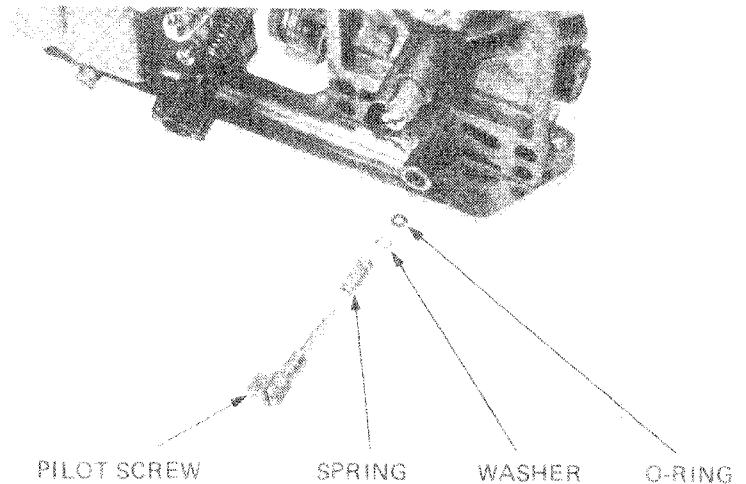

FLOAT LEVEL

Remove the float chamber. Measure the float level with the float tip just contacting the float valve and the carburetor inclined $15^\circ \sim 45^\circ$ from vertical.

FLOAT LEVEL: 15.5 ± 1 mm (0.61 ± 0.04 in)

Replace the float if the float level is not within the specification.

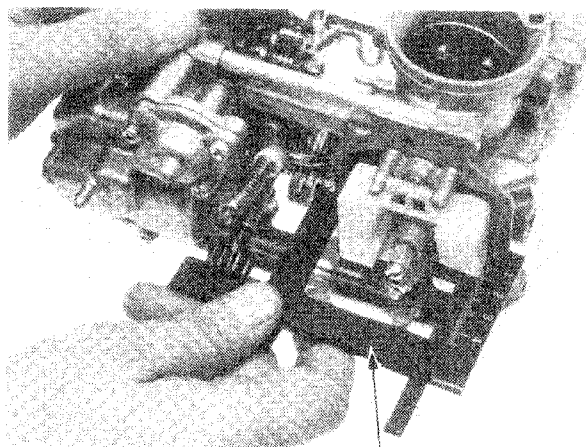

FLOAT LEVEL GAUGE
07401-0010000



FAST IDLE ADJUSTMENT

FAST IDLE : 1,500 – 2,500 rpm

If adjustment of the fast idle is necessary, remove the carburetor, and close the throttle valve by turning the throttle stop screw out.

Adjust by opening or closing the fork end of the choke link arm until the clearance between the choke link arm and the throttle drum is about 0.8 mm (0.047 in).

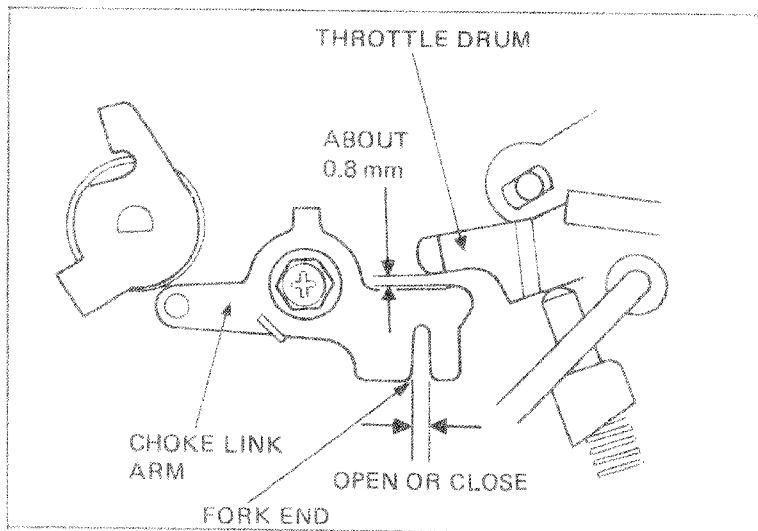

ACCELERATOR PUMP ADJUSTMENT

Loosen the throttle stop screw, so the throttle valve is closed.

Measure the clearance between the accelerator pump rod and the choke link arm with the throttle valve closed.

CLEARANCE: 0.1–0.3 mm (0.004–0.012 in)

Adjust by bending the choke link arm.

Measure the clearance between the choke link arm and stopper on the carburetor.

CLEARANCE: 3.1–3.3 mm (0.12–0.13 in)

Adjust by bending the choke link arm.

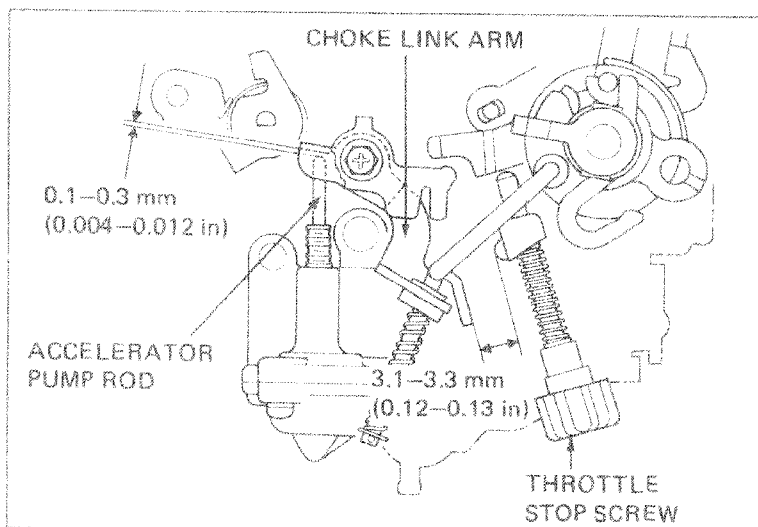



FUEL SYSTEM

CARBURETOR INSTALLATION

The installation sequence is essentially the reverse of removal.

NOTE

Check the throttle and choke valve operation before installation.

After installation, perform the following adjustments.

- Throttle grip free play (Page 3-4).
- Carburetor synchronization (Page 3-9).
- Idle speed adjustment (Page 3-10).
- Pilot screw setting and adjustment (Page 4-12).

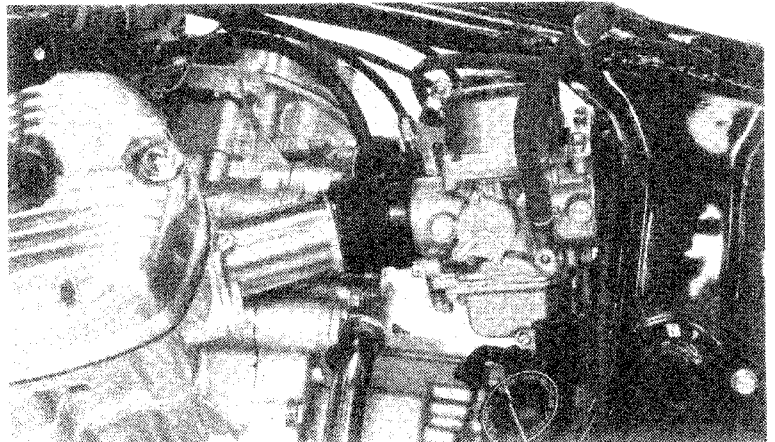

PILOT SCREW ADJUSTMENT

IDLE DROP PROCEDURE

NOTE

- The pilot screws are factory pre-set and no adjustment is necessary unless the pilot screw is replaced (see removal above).
- Limiter caps restrict adjustment to 7/8 turn.
- Use a tachometer with graduations of 100 rpm or smaller and that will accurately indicate a 100 rpm change.

CAUTION

Any forcible attempt to remove the pilot screw limiter caps will cause screw breakage.

1. Turn each pilot screw clockwise until it seats lightly and back it out to the specification given. This is an initial setting prior to the final pilot screw adjustment.

INITIAL OPENING: 1-5/8 turns out

2. Warm up the engine to operating temperature. Stop and go driving for approximately 10 minutes will be sufficient.
3. Attach a tachometer.
4. Adjust the idle speed with the throttle stop screw.

IDLE SPEED: 1,100 ± 100 rpm

5. Turn the pilot screw in or out to obtain the highest engine speed.
6. Readjust the idle speed with the throttle stop screw.
7. Turn the pilot screw in gradually until the engine speed drops 100 rpm.

PILOT SCREW

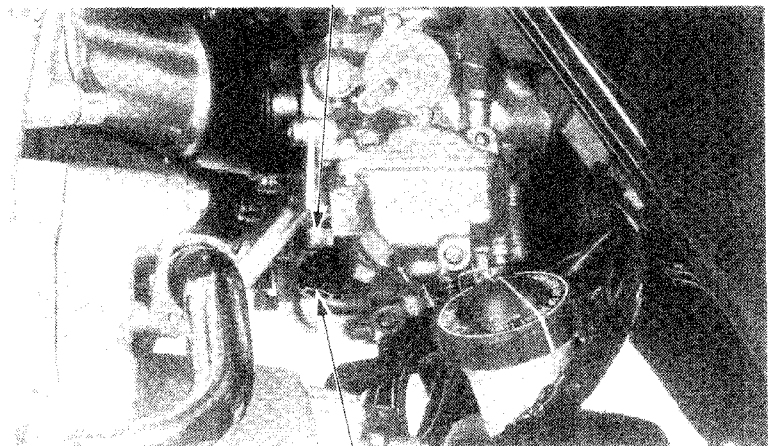

THROTTLE STOP SCREW



NOTE

If the pilot screw seats before lowering the engine speed 100 rpm, continue to step 8.

2. Turn the pilot screw 1 turn open from the position obtained in step 7.
9. Readjust the idle speed with the throttle stop screw.
- 10 Repeat steps 6 through 8 for the remaining carburetor.
11. Apply Loctite ® 601 or equivalent to the inside of the limiter caps. Place the caps over the pilot screws so that their tabs rest against the float chamber stop (Rich side), preventing further adjustment that would enrich the fuel mixture (No counterclockwise rotation is permitted.).

NOTE

Do not turn the pilot screw when installing the limiter caps.

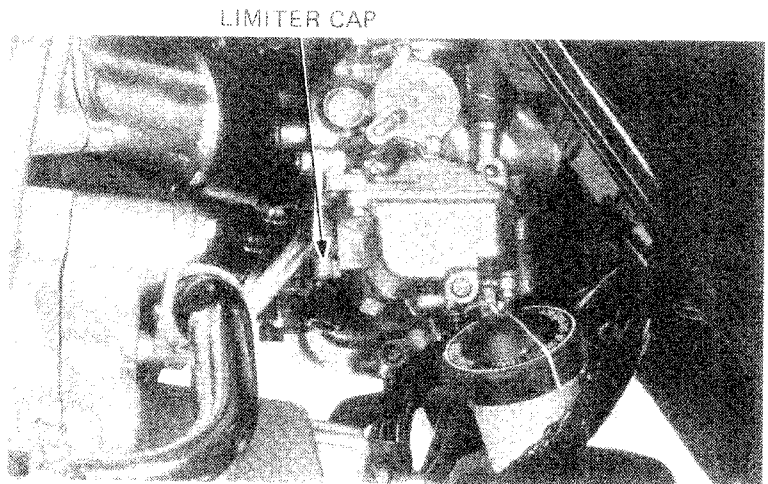

HIGH ALTITUDE ADJUSTMENT (USA ONLY)

When the vehicle is to be operated continuously above 6,500 ft (2,000 m) the carburetors must be readjusted as described below to improve drivability and decrease exhaust emissions.

1. Warm up the engine to operating temperature. Stop and go driving for 10 minutes is sufficient.
2. Turn each pilot screw clockwise 1/2 turn.
3. Adjust the idle speed to 1,100 ± 100 rpm with the throttle stop screw.

NOTE

These adjustments must be made at high altitude to ensure proper high altitude operation.

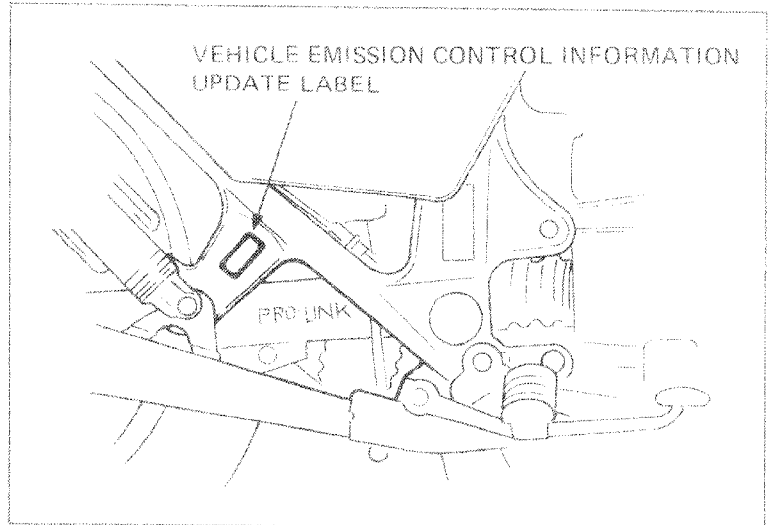

4. Attach the Vehicle Emission Control Information Update label as shown. Refer to service Bulletin SL#132 for information on obtaining the label.

NOTE

Do not attach the label to any part that can be easily removed from the vehicle.

WARNING

Operation at an altitude lower than 5,000 ft (1,500 m) with the carburetors adjusted for high altitudes may cause the engine to idle roughly and stall.

When the vehicle is to be operated continuously below 5,000 ft (1,500 m), turn each pilot screw counterclockwise to its original position against its stop and adjust the idle speed to 1,100 ± 100 rpm. Be sure to do these adjustments at low altitude.



FUEL SYSTEM

FUEL TANK

WARNING

*Keep gasoline away from open flames or sparks.
Wipe up spilled gasoline at once.*

FUEL TANK REMOVAL

Remove the seat.
Remove the fuel tank mount bolt.

Disconnect the fuel tube, vacuum tube and air vent tube.
Remove the fuel tank.

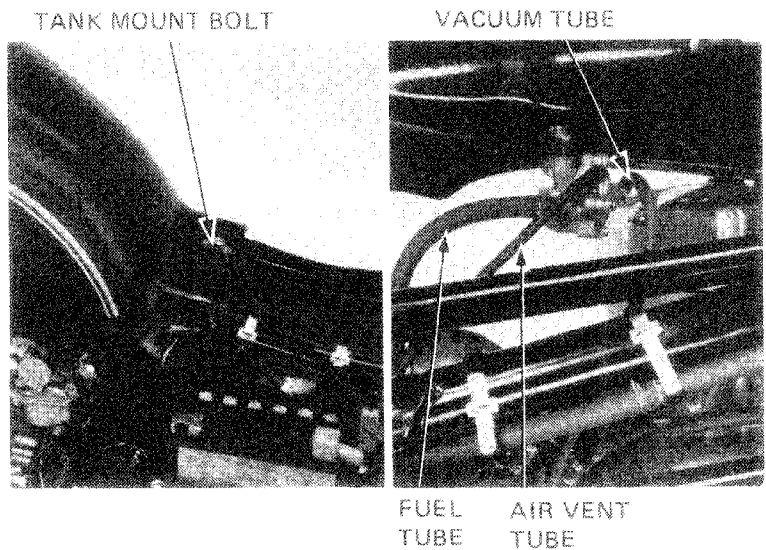

FUEL VALVE INSPECTION

Check that the fuel tank is full and turn the fuel valve ON.

Fuel should flow out from the fuel outlet tube when 12–20 mm Hg (0.5–0.8 in Hg) of vacuum is applied.

If the flow of fuel is restricted, turn the fuel valve to RES and check if the fuel will flow out.

If fuel flows out of the fuel outlet, the fuel valve diaphragm is damaged or fuel or vacuum circuit is clogged.

If the flow of fuel is still restricted with the fuel valve in RES, this indicates that the fuel valve strainer, fuel passage or fuel tank cap breather hole is clogged.

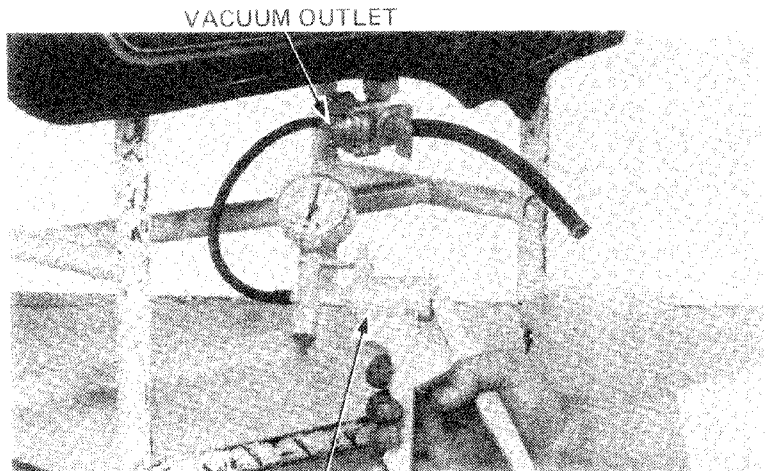

FUEL STRAINER DIASSEMBLY

Drain the fuel from the fuel tank.
Remove the fuel valve by loosening the lock nut.

NOTE

Hold the fuel valve body while turning the lock nut.

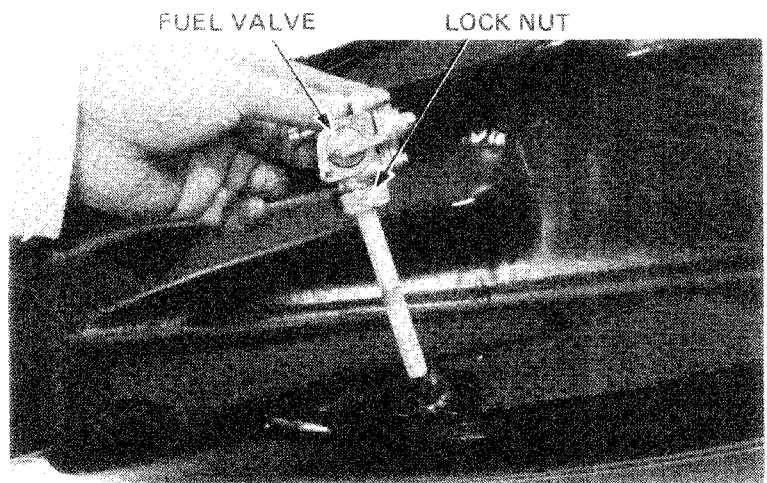



Remove the fuel strainer screen.
Blow dust and sediment off the screen using compressed air.
Check the O-ring for deterioration or damage and replace it with a new one if necessary.
Remove the diaphragm cover by removing the four attaching screws.

STRAINER SCREEN



DIAPHRAGM COVER



Inspect the diaphragm for deterioration or damage.
Clean the fuel valve using compressed air.

DIAPHRAGM

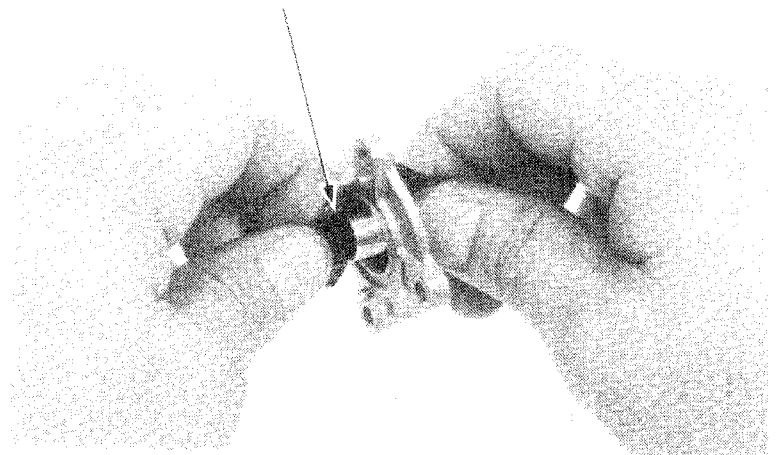

NOTE

Blow open all passages with the valve in ON and RES positions.

FUEL VALVE ASSEMBLY

Assembly is the reverse order of disassembly.

NOTE

- Make sure that the diaphragm is not pinched in the valve body.
- After installation, check the operation of the fuel valve. Also make sure that fuel is not leaking.
- Hold the fuel valve while turning the fuel valve retaining nut.

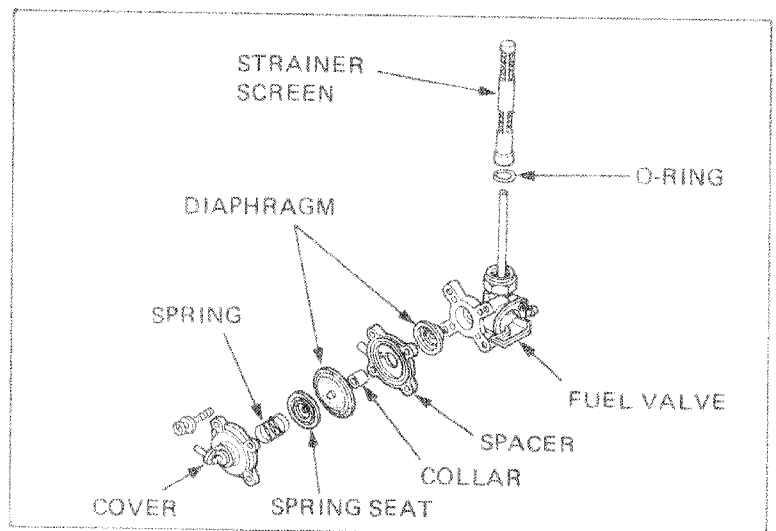

AIR CLEANER CASE

AIR CLEANER CASE REMOVAL

Remove the battery and remove the 6 mm bolt.
Remove the three 6 mm bolts and air cleaner case bracket.
Loosen the intake tube band screws.

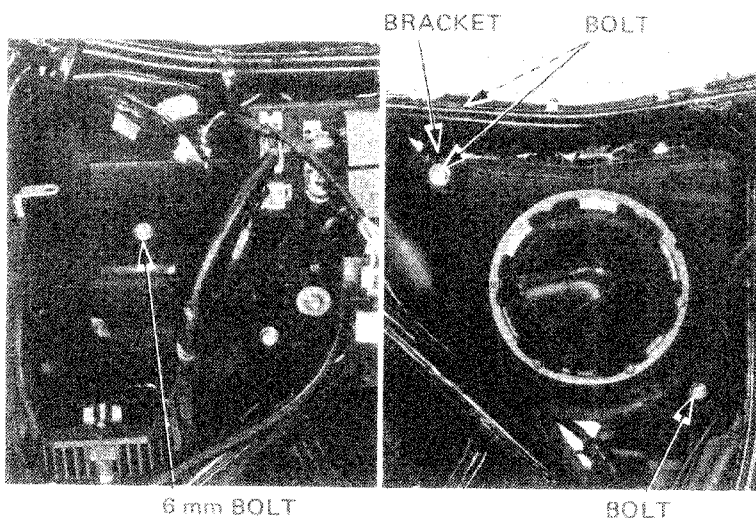

Disconnect the breather separator tube from the air cleaner case and remove the air cleaner case from the right side.

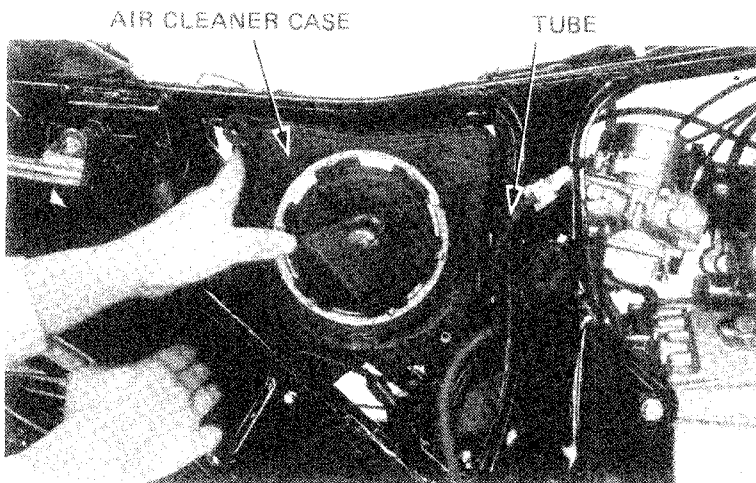

Disconnect the breather tube and drain tube from the breather separator.
Remove the breather separator.

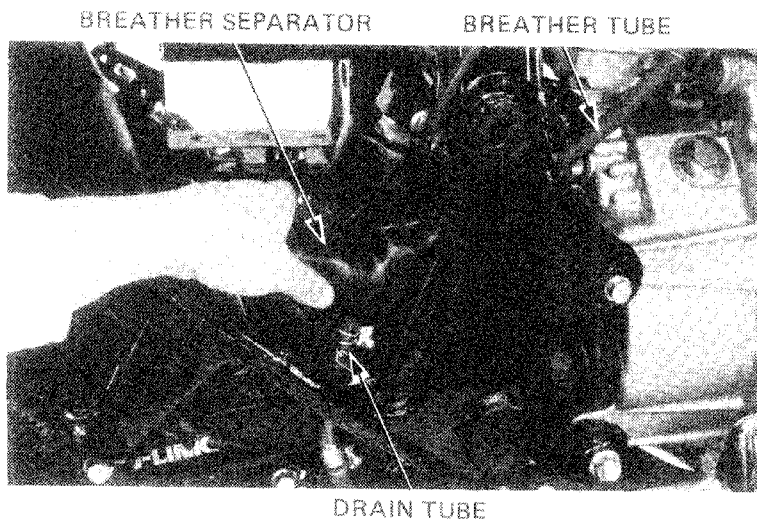



AIR CLEANER CASE INSTALLATION

Installation of the air cleaner case is essentially the reverse order of removal.

NOTE

Apply sealing agent to the intake tube when installing.

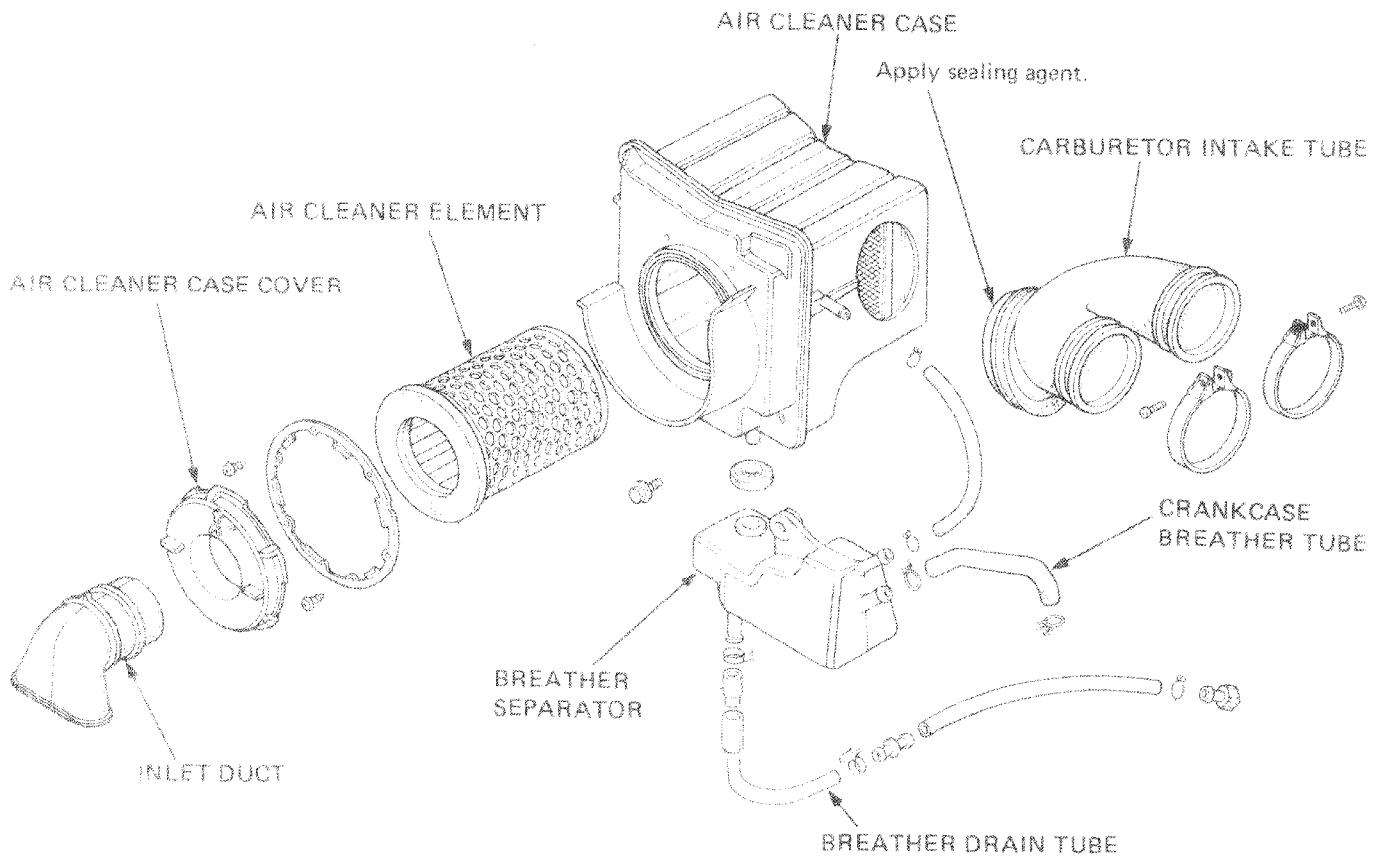

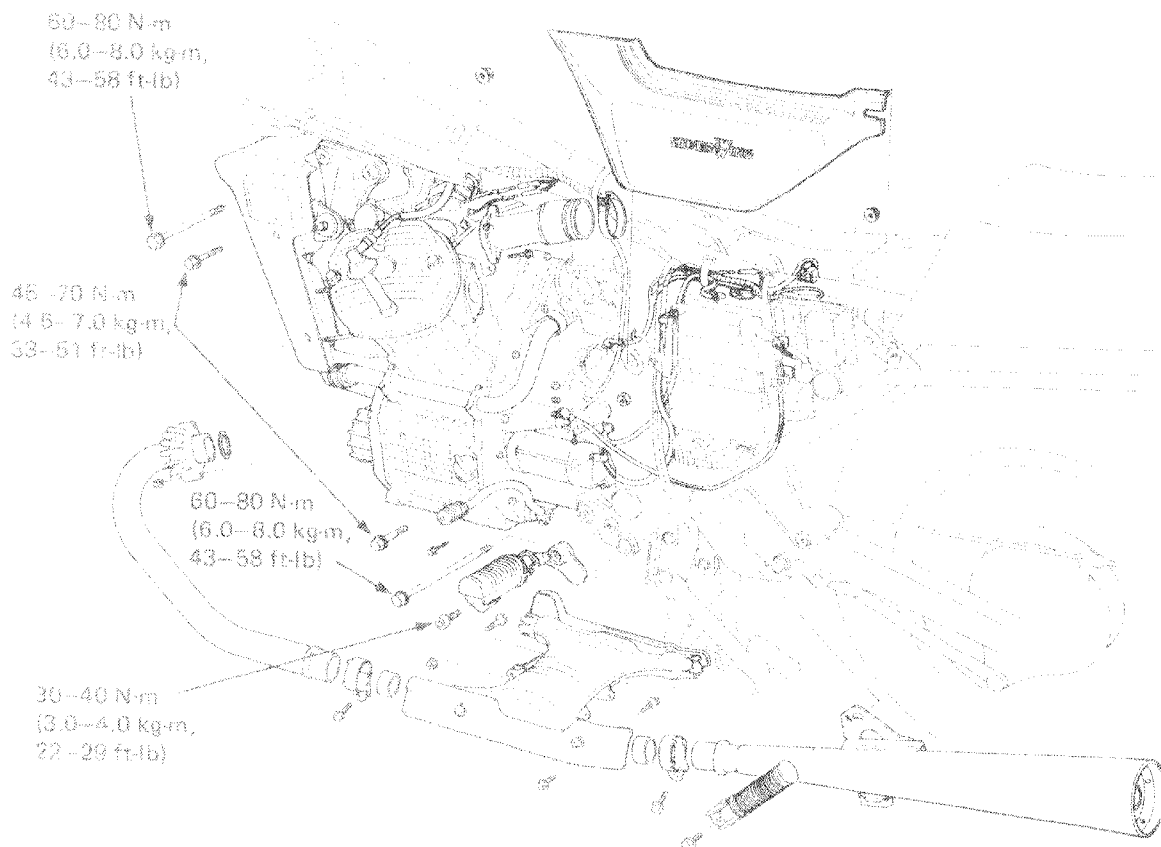
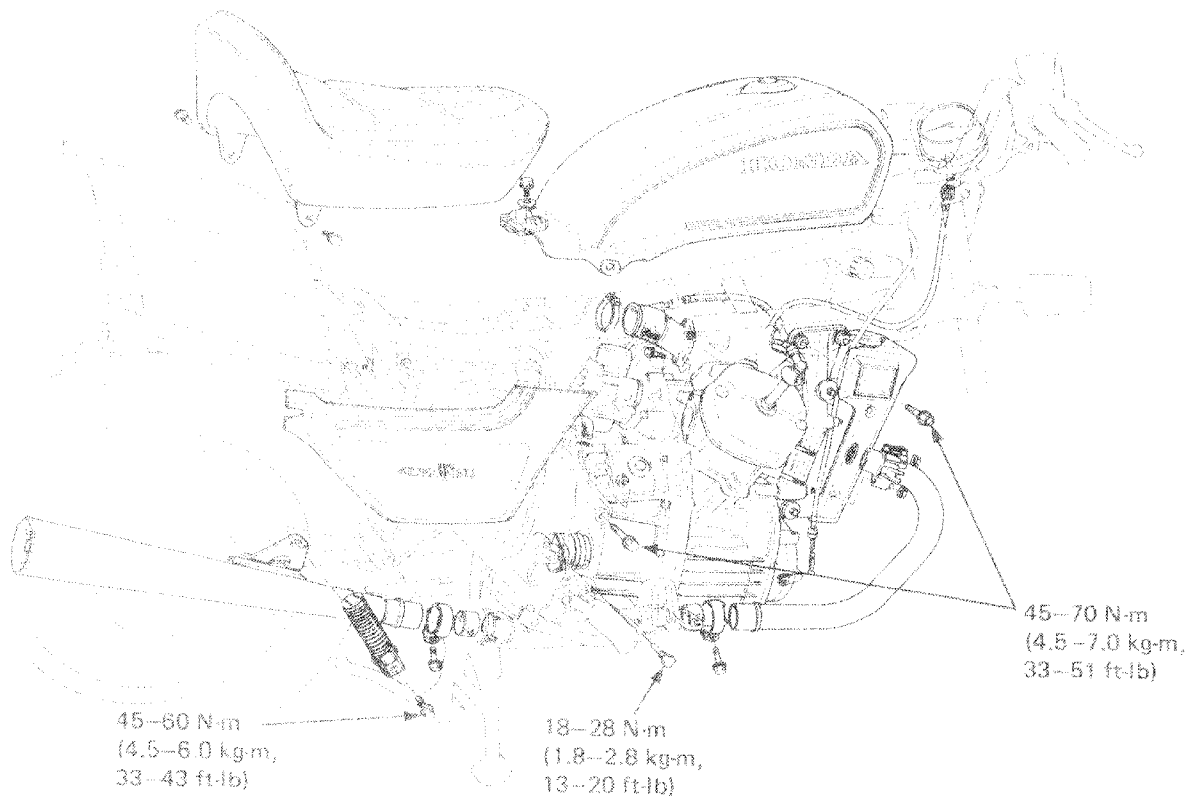



SERVICE INFORMATION	5-1
ENGINE REMOVAL	5-2
ENGINE INSTALLATION	5-7

SERVICE INFORMATION

GENERAL INSTRUCTIONS

- Parts requiring engine removal for servicing:
 - Crankshaft, Piston
 - Connecting rods
 - Camshafts
 - Flywheel and starting clutch
 - Gearshift spindle
 - Transmission
 - Water pump mechanical seal
- Remove and install the engine with a hydraulic jack to support its weight.
- Drain the engine oil before removing the engine if the front or rear cover is to be removed.
- For cooling system removal and installation, see section 9, Cooling System.

SPECIFICATIONS

Engine weight	71,5 kg (158 lbs)
Engine oil capacity	3.0 lit (3.2 US qt)
Engine oil recommendation	See page 2-1
Coolant capacity (Radiator and engine)	1.8 lit (1.9 US qt)

TORQUE VALUES

Front engine hanger nut	30 – 40 N·m (3.0 – 4.0 kg·m, 22 – 29 ft·lb)
Front engine mount bolt (10 mm)	45 – 70 N·m (4.5 – 7.0 kg·m, 33 – 51 ft·lb)
(12 mm)	60 – 80 N·m (6.0 – 8.0 kg·m, 43 – 58 ft·lb)
Rear engine mount bolt (10 mm)	45 – 70 N·m (4.5 – 7.0 kg·m, 33 – 51 ft·lb)
(12 mm)	60 – 80 N·m (6.0 – 8.0 kg·m, 43 – 58 ft·lb)
Final drive shaft lock bolt	18 – 28 N·m (1.8 – 2.8 kg·m, 13 – 20 ft·lb)
Left foot peg bolt	30 – 40 N·m (3.0 – 4.0 kg·m, 22 – 29 ft·lb)
Passenger foot peg bolt	45 – 60 N·m (4.5 – 6.0 kg·m, 33 – 43 ft·lb)
Power chamber bolt	24 – 30 N·m (2.4 – 3.0 kg·m, 17 – 22 ft·lb)
Muffler band bolt	18 – 28 N·m (1.8 – 2.8 kg·m, 13 – 20 ft·lb)



ENGINE REMOVAL/INSTALLATION

ENGINE REMOVAL

Turn the fuel valve off.
Remove the seat and fuel tank.
Remove the right and left side covers.

Remove the exhaust pipe clamp nuts.
Loosen the exhaust pipe clamp bolts and remove the exhaust pipes.

EXHAUST PIPE CLAMP NUTS

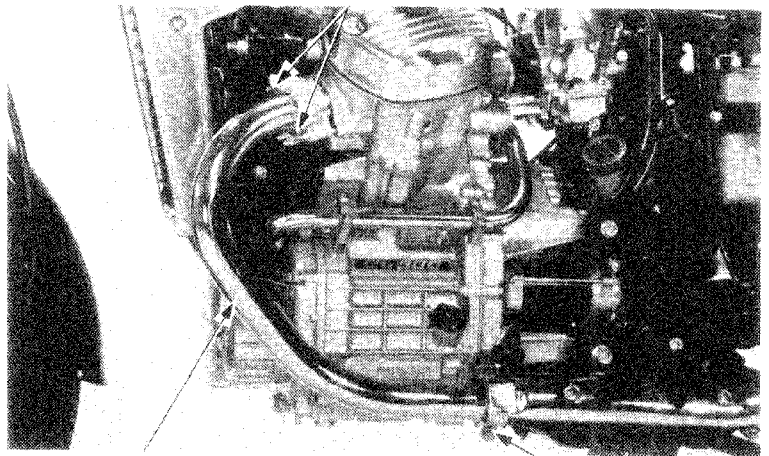

EXHAUST PIPE

CLAMP BOLT

Remove the muffler mounting bolts.
Loosen the muffler clamp bolts, and remove the exhaust mufflers.

MOUNTING BOLT

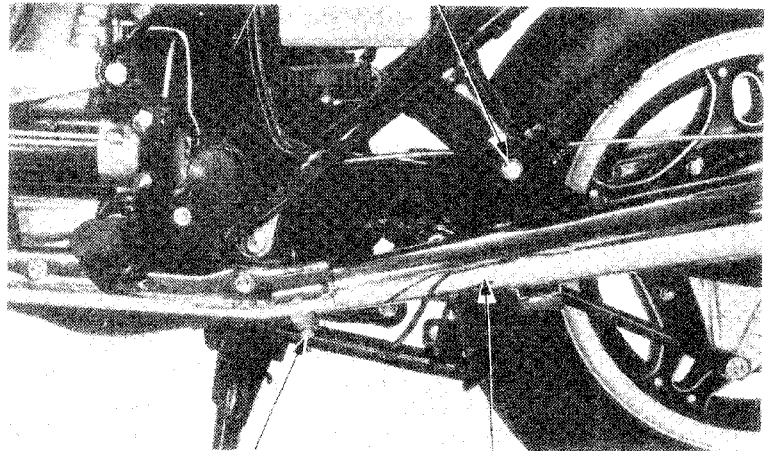

CLAMP BOLT

MUFFLER

Remove the power chamber bolts.
Remove the power chamber.

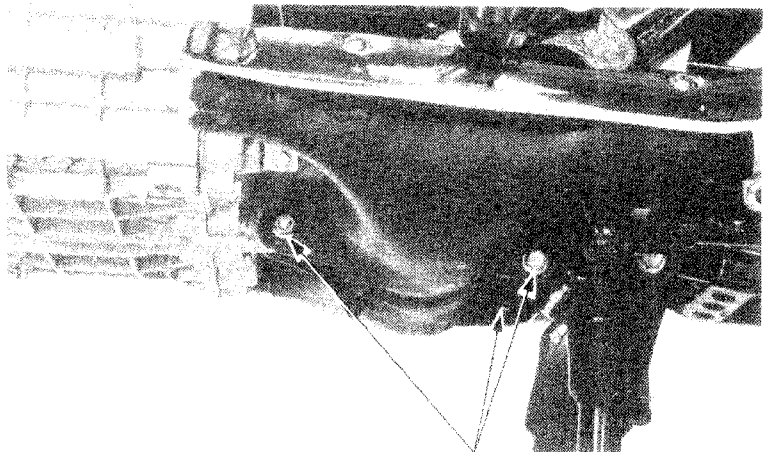

POWER CHAMBER BOLTS



Disconnect the starter motor and battery ground cables.

Remove the left foot peg bracket.

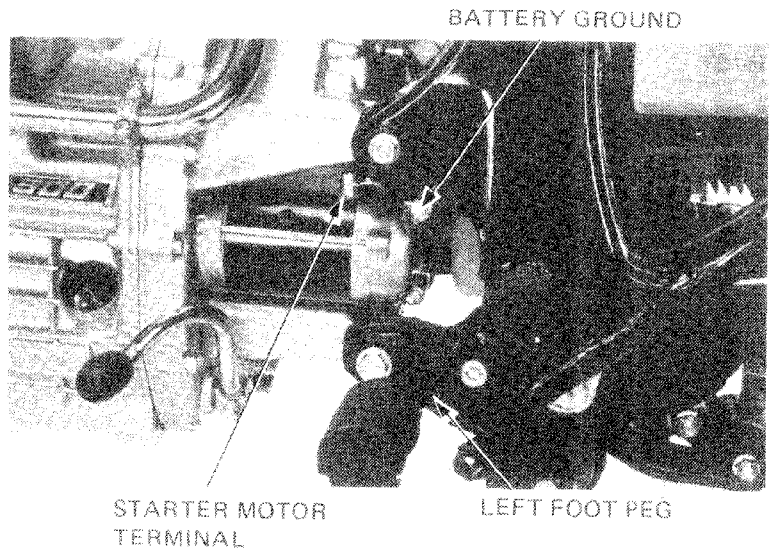

Remove the wire harness bands.
Disconnect the pulse generator and A.C. generator cables at the couplers.
Disconnect the neutral switch wire (Light green/Red).

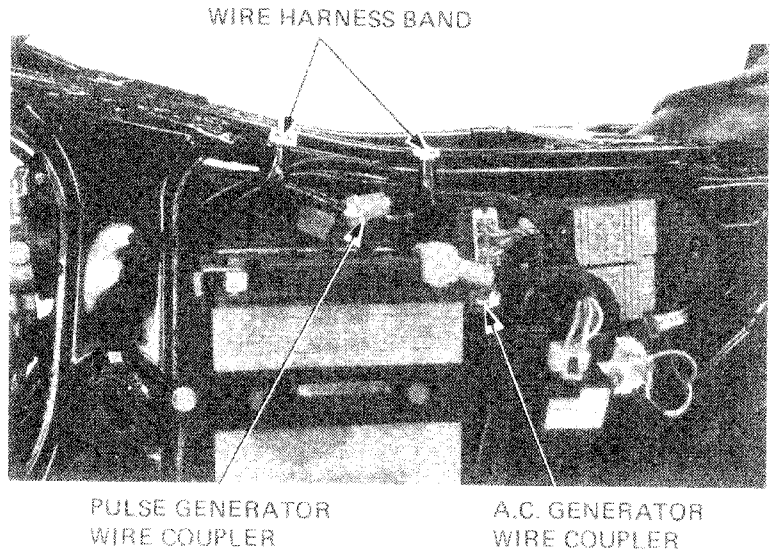

Disconnect the clutch cable at the lower end.
Disconnect the tachometer cable at the tachometer.

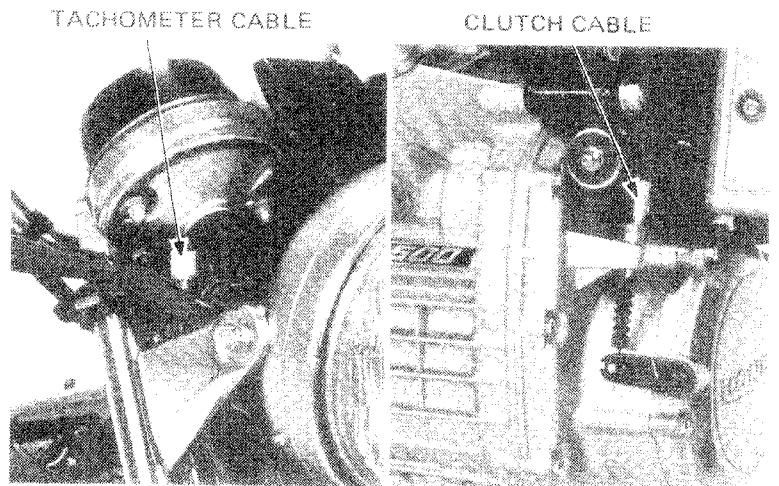



ENGINE REMOVAL/INSTALLATION

LOCK BOLT

Remove the drive shaft lock bolt.

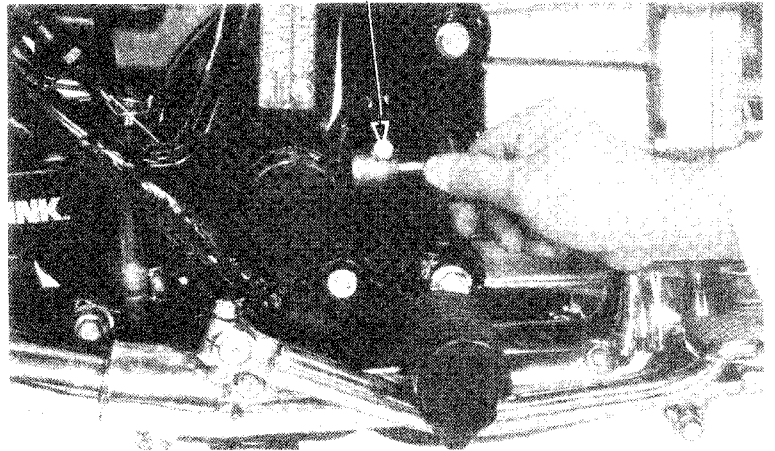

Disconnect the siphon tube at the connection.
Disconnect the thermostatic switch (Green/Blue)
and oil pressure switch (Blue/Red) wires.
Remove the spark plug caps.

SIPHON TUBE

THERMOSTATIC SWITCH WIRE

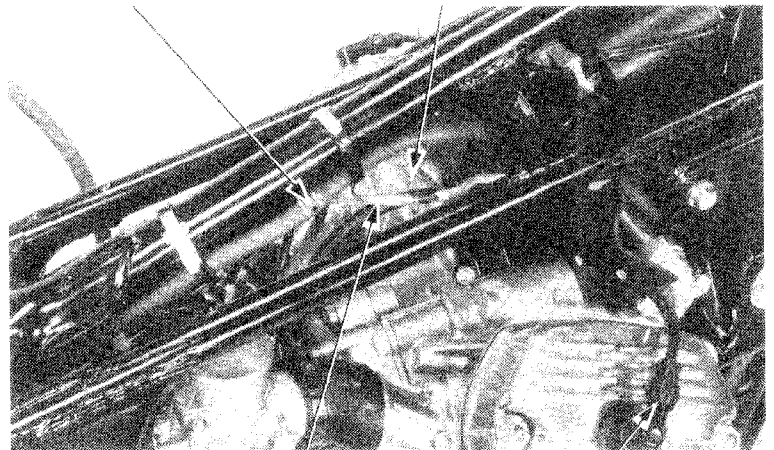

OIL PRESSURE
SWITCH WIRE

SPARK PLUG
CAP

Remove the carburetor intake pipes.
Disconnect the crankcase breather tube.

INTAKE PIPE

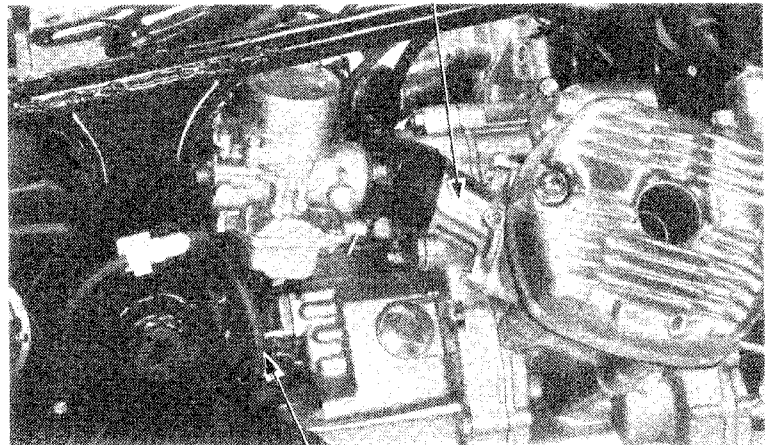

BREATHER TUBE



Place a jack under the engine to support its weight.
Remove the engine rear mounting bolts.

ENGINE REAR MOUNTING BOLTS

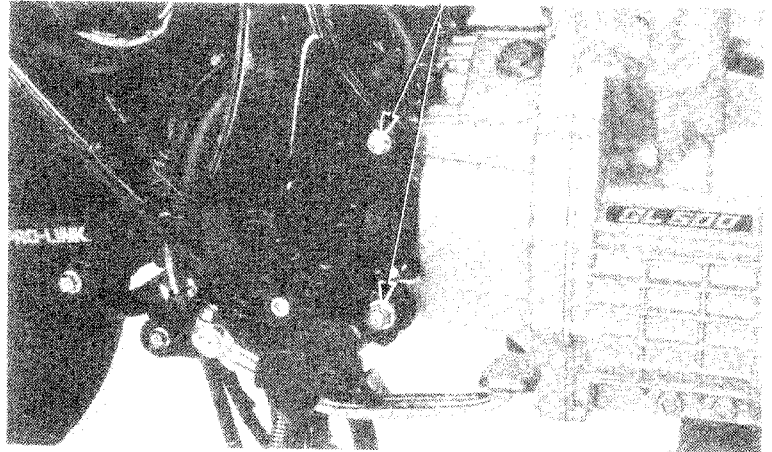

Remove the engine front mounting bolts.

FRONT MOUNTING BOLTS

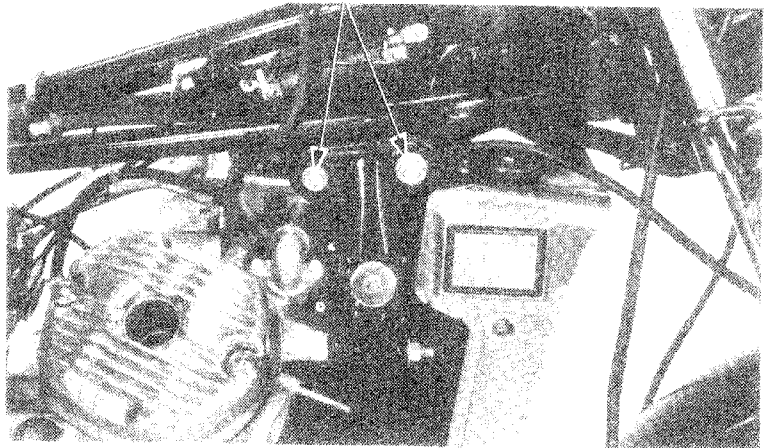

Disengage the drive shaft from the U-joint assembly
by adjusting the jack height and moving the engine
forward.

Remove the engine from the frame.

CAUTION

*Jack height must be continuously adjusted
during engine removal and installation to
prevent damage to mounting bolt threads,
wire harnesses and cables.*

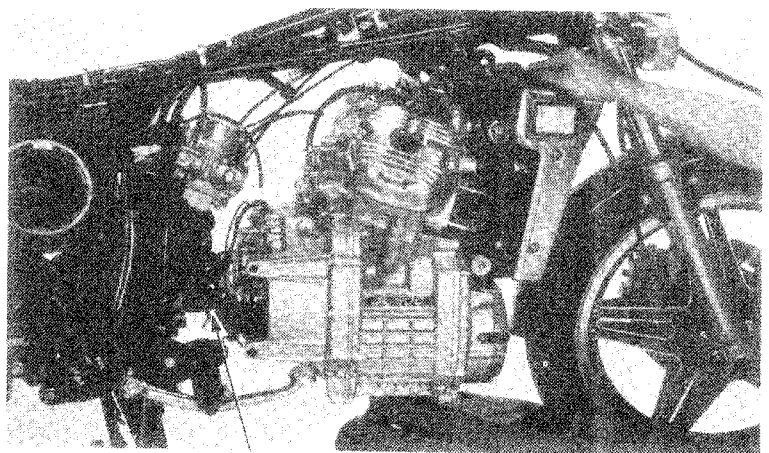

DRIVE SHAFT



ENGINE REMOVAL/INSTALLATION

Drain the coolant from the radiator (Page 9-3).
Remove the radiator cover and radiator (Page 9-5).
Remove the cooling fan and front engine hanger (Page 9-6).

FRONT ENGINE MOUNTS

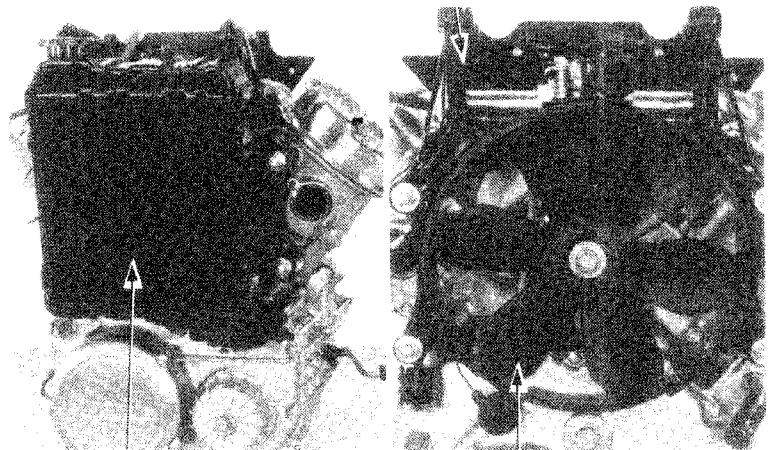

RADIATOR

COOLING FAN

Remove the tachometer cable.
Remove the drain bolts and drain the coolant from the cylinders.

TACHOMETER CABLE

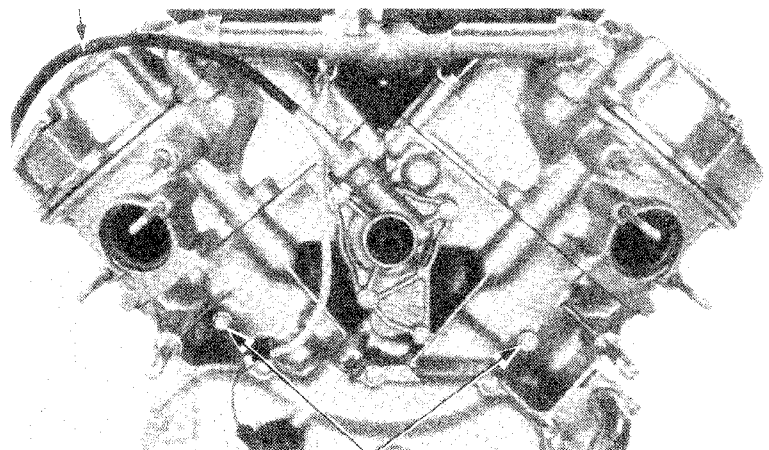

CYLINDER DRAIN BOLTS

Disconnect the by-pass hose.
Remove the air spoiler thermostat and water pipes.

THERMOSTAT CASE

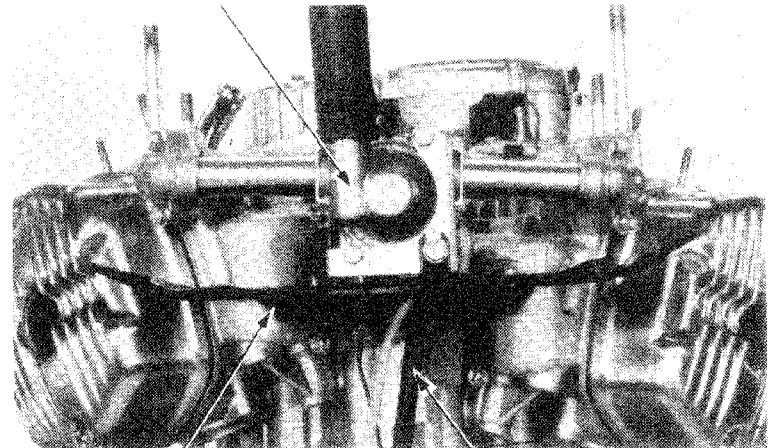

AIR SPOILER

BY-PASS HOSE



ENGINE INSTALLATION

The installation sequence is essentially the reverse of removal.

Place the transmission into gear.

Raise the engine with a jack and align the drive shaft with the final shaft.

Slide the drive shaft into the U-joint assembly by moving the engine backward.

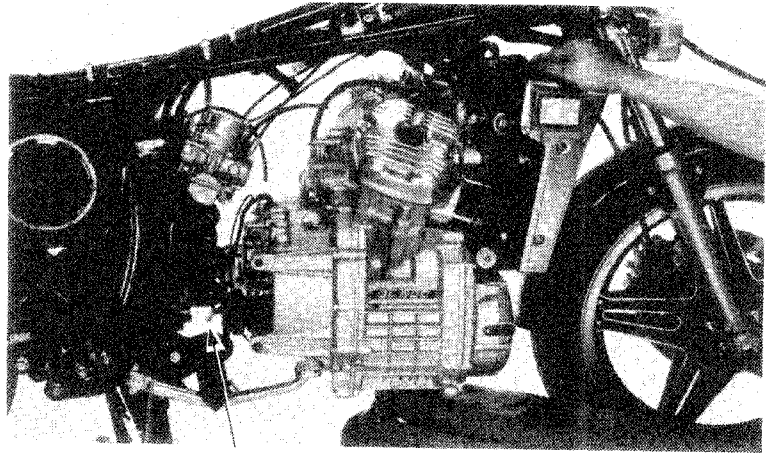

DRIVE SHAFT

NOTE

- Make sure that the final drive splines are exposed 5–6 mm from the end of the U-joint.
- Lubricate the final shaft splines with lithium-based multipurpose grease NLGI No. 2 (MoS₂ additive) before installation.
- Align the mounting surfaces carefully to prevent damage to mounting bolt threads, wire harnesses and cables.
- Route the wires and cables properly (Page 1-7, 8).

Tighten the engine mount bolt and drive shaft lock bolt. (Page 14-24).

45–70 N·m
(4.5–7.0 kg·m, 33–51 ft·lb)

60–80 N·m
(6.0–8.0 kg·m, 43–58 ft·lb)

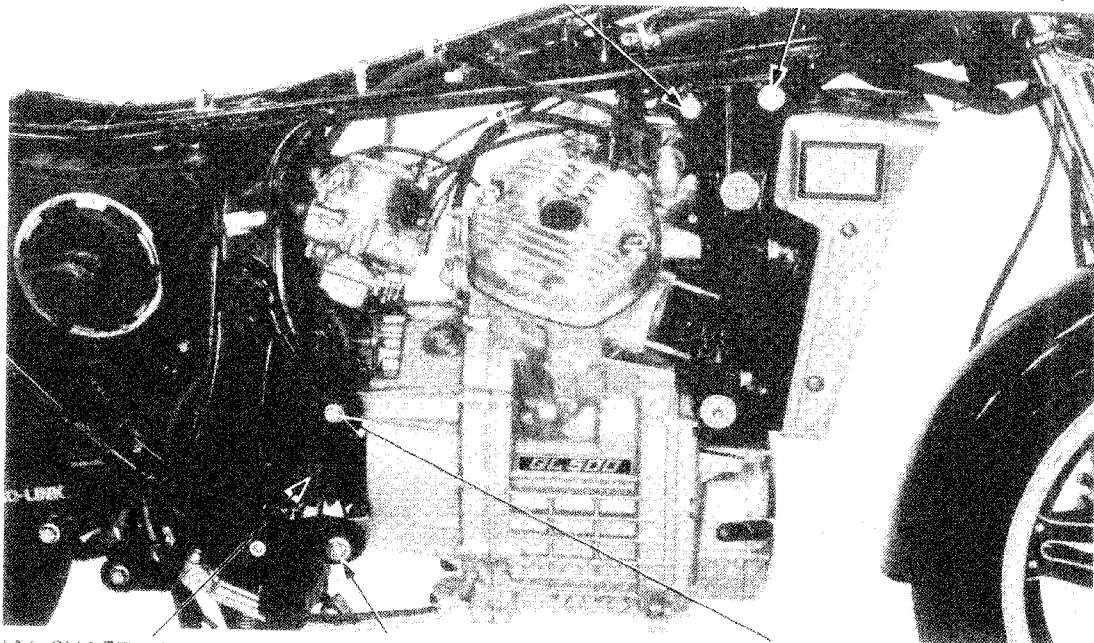

FINAL SHAFT LOCK BOLT
18–28 N·m
(1.8–2.8 kg·m, 13–20 ft·lb)

60–80 N·m
(6.0–8.0 kg·m, 43–58 ft·lb)

45–70 N·m
(4.5–7.0 kg·m, 33–51 ft·lb)

NOTE

- Fill the engine with the recommended oil and coolant.
- Perform the following inspections and adjustments:

Clutch free play (Page 3-14).	Radiator coolant (Page 3-10)
Engine oil level (Page 2-2).	Engine oil and coolant leakage.



CYLINDER HEAD/VALVE

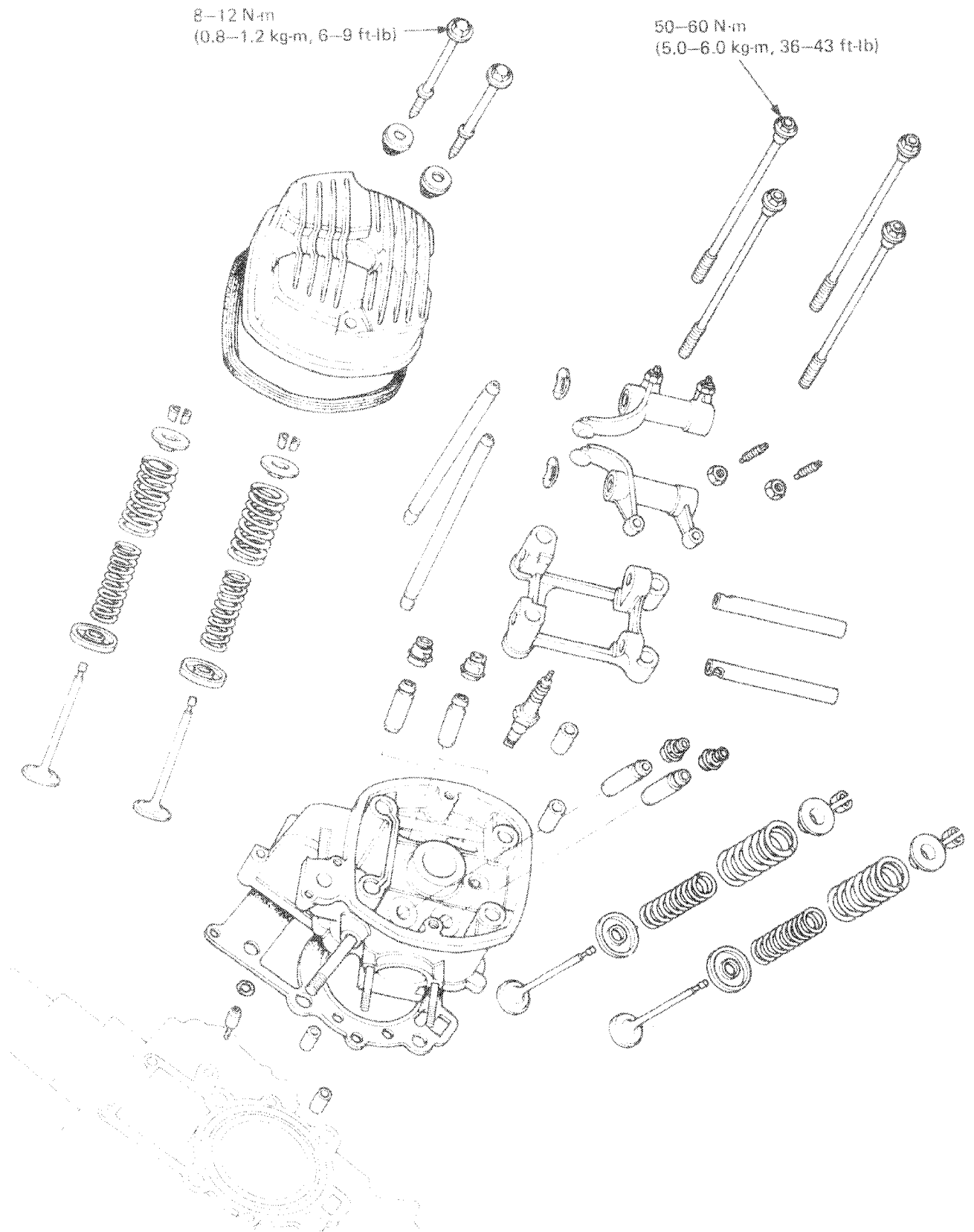



SERVICE INFORMATION	6-1
TROUBLESHOOTING	6-2
ROCKER ARM/CYLINDER HEAD REMOVAL	6-3
CYLINDER HEAD DISASSEMBLY	6-7
VALVE GUIDE REPLACEMENT	6-9
VALVE SEAT INSPECTION AND GRINDING	6-10
CYLINDER HEAD ASSEMBLY	6-13
ROCKER ARM ASSEMBLY	6-14
CYLINDER HEAD/ROCKER ARM INSTALLATION	6-14

SERVICE INFORMATION

GENERAL INSTRUCTIONS

- All cylinder head maintenance and inspection can be accomplished with the engine installed. Before removing the cylinder heads, it is necessary to drain coolant from the cylinder water jackets by removing the drain bolts.
- The engine must be cool before removing the cylinder head.

TOOLS

Special

Valve guide driver attachment (IN/EX)	07934-4150000
Valve guide reamer (IN/EX)	07984-6110000 or 07984-6570100

Common

Valve spring compressor	07757-0010000
Valve guide remover (6.6 mm) (IN/EX)	07742-0010200 or 07942-6570100

TORQUE VALUES

Head cover bolt	8 - 12 N·m (0.8 - 1.2 kg-m, 6-9 ft-lb)
Cylinder head bolt	50 - 60 N·m (5.0 - 6.0 kg-m, 36 - 43 ft-lb)
Front engine mount bolt (10 mm)	45 - 70 N·m (4.5 - 7.0 kg-m, 33 - 51 ft-lb)
(12 mm)	60 - 80 N·m (6.0 - 8.0 kg-m, 43 - 58 ft-lb)
Front engine hanger nut	30 - 40 N·m (3.0 - 4.0 kg-m, 22 - 29 ft-lb)
Cooling fan bolt	20 - 25 N·m (2.0 - 2.5 kg-m, 14 - 18 ft-lb)



SPECIFICATIONS

Unit: mm (in)

Item			Standard	Service Limit
Cylinder compression (cold)			1,200 kPa (1.20 kg/cm ² , 171 psi)	—
Rocker arms	Shafts and holders	Rocker arm I.D.	15.000 – 15.018 (0.5906–0.5913)	15.04 (0.592)
		Rocker arm shaft O.D.	14.966 – 14.984 (0.5892 – 0.5899)	14.95 (0.589)
		Rocker arm holder I.D.	14.988 – 15.006 (0.5901 – 15.908)	15.03 (0.592)
Valve spring	Free length	Outer (IN)	50.40 (1.984)	48.50 (1.909)
		Inner (IN)	50.30 (1.980)	48.40 (1.905)
		Outer (EX)	50.40 (1.984)	48.50 (1.909)
		Inner (EX)	50.30 (1.980)	48.40 (1.905)
	Preload/Length	Outer (IN)	28 kg/39.9 mm (61.7 lbs/1.5709 in)	26.5 kg/39.8 mm (58.4 lbs/1.5670 in)
		Inner (IN)	11.5 kg/37.9 mm (25.4 lbs/1.4921 in)	10.5 kg/37.9 mm (23.2 lbs/1.4921 in)
		Outer (EX)	28.5 kg/39.9 mm (62.8 lbs/1.5709 in)	26.5 kg/39.8 mm (58.4 lbs/1.5670 in)
		Inner (EX)	11.5 kg/37.9 mm (25.4 lbs/1.492 in)	10.5 kg/37.9 mm (23.2 lbs/1.4921 in)
Valves and valve guides	Stem O.D.	(IN)	6.580 – 6.590 (0.2591 – 0.2594)	6.54 (0.258)
		(EX)	6.550 – 6.560 (0.2579 – 0.2583)	6.54 (0.258)
	Guide I.D.	(IN)	6.600 – 6.620 (0.2598 – 0.2606)	6.70 (0.264)
		(EX)	6.600 – 6.620 (0.2598 – 0.2606)	6.70 (0.264)
	Stem-to-guide clearance	(IN)	—	0.10 (0.040)
		(EX)	—	0.10 (0.040)
Cylinder head	Valve seat width	1.1–1.3 (0.04–0.05)	2.0 (0.08)	
	Warpage	—	0.10 (0.040)	

TROUBLESHOOTING

Engine top-end problems are usually performance related which can be diagnosed by a compression test, or are noises which can usually be traced to the top-end with a sounding rod or stethoscope.

Low Compression or Uneven Compression

1. Valve
 - Incorrect valve clearance
 - Burned or bent valves
 - Broken valve spring
 - Incorrect valve timing
 - Sticking valve
2. Cylinder head
 - Leaking or damaged head gasket
 - Warped or cracked cylinder head
3. Cylinder and piston

High Compression

1. Excessive carbon build-up on piston crown or combustion chamber

Excessive Noise

1. Incorrect valve adjustment
2. Sticking valve or broken valve spring
3. Damaged rocker arm or camshaft
4. Bent push rod

Contaminated Engine Oil or Coolant

1. Leaking head gasket



ROCKER ARM/CYLINDER HEAD REMOVAL

NOTE

Rocker arm can be removed without removing the cooling system.

Remove the radiator and cooling fan (page 9-5).
Remove the cooling fan cover and front engine hanger.

COOLING FAN COVER

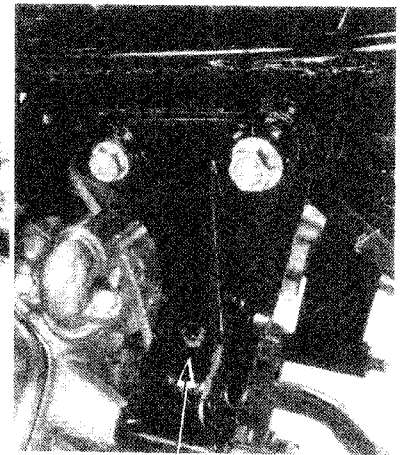
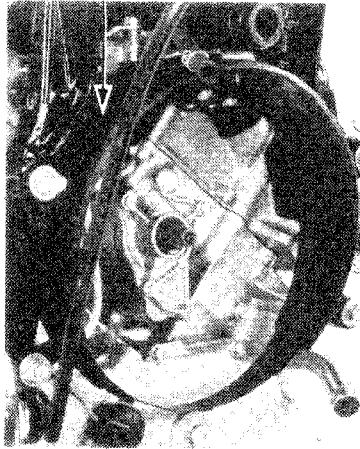

FRONT ENGINE HANGER

Remove the carburetor intake pipe.
Remove the exhaust pipe.

INTAKE PIPE

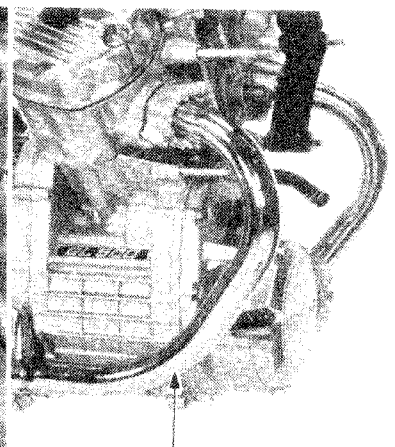
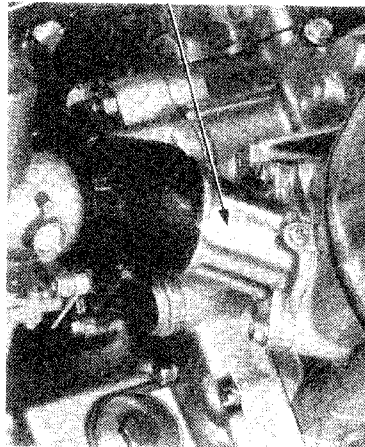

EXHAUST PIPE

Remove the water pipe joints and water pipes.

WATER PIPE

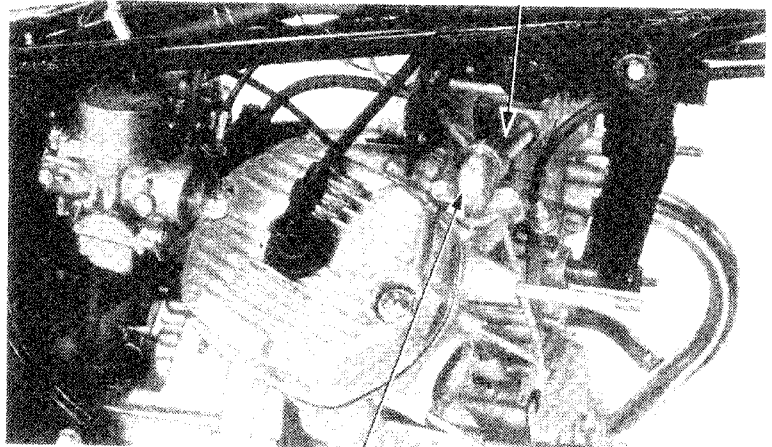

WATER PIPE JOINT



CYLINDER HEAD/VALVE

Remove the air spoiler.
Remove the thermostat unit with bracket (Page 9-4).

Remove the spark plug cap.
Remove the cylinder head cover.

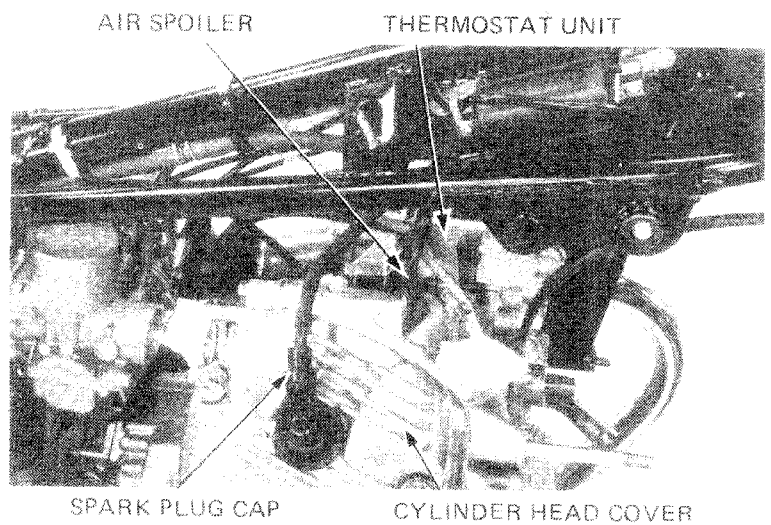

Remove the crankshaft hole cap and timing inspection cap.
Bring the piston to T.D.C. of the compression stroke by turning the crankshaft.

NOTE

- * Align the index mark with the "TR" mark for the right cylinder.
- * Align the index mark with the "TL" mark for the left cylinder.

Loosen the cylinder head bolts in a crisscross pattern in two or more steps.

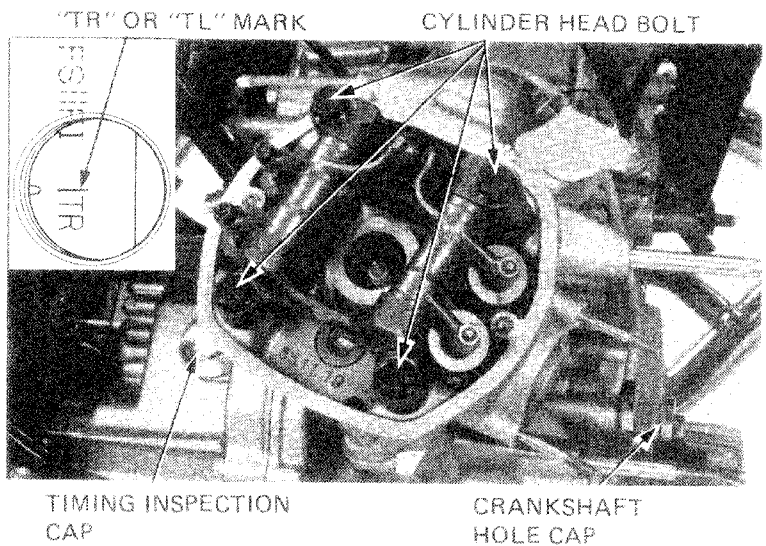

Remove the rocker arm holder assembly.

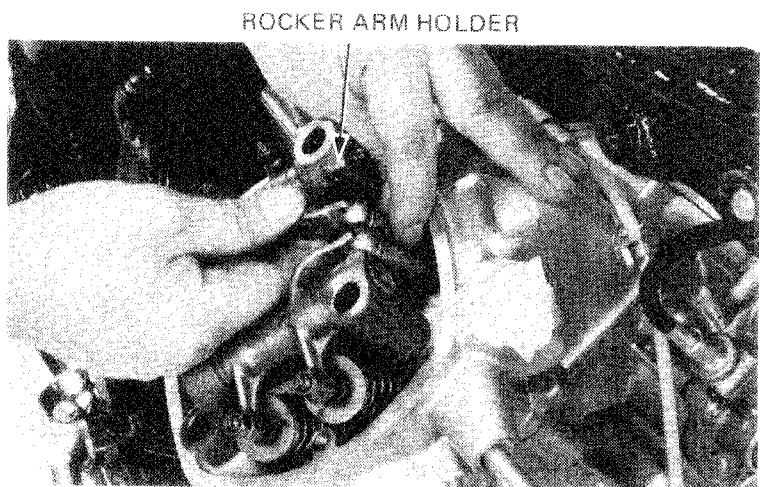



Remove the push rods.
Remove the cylinder head dowel pins.
Remove the cylinder head.

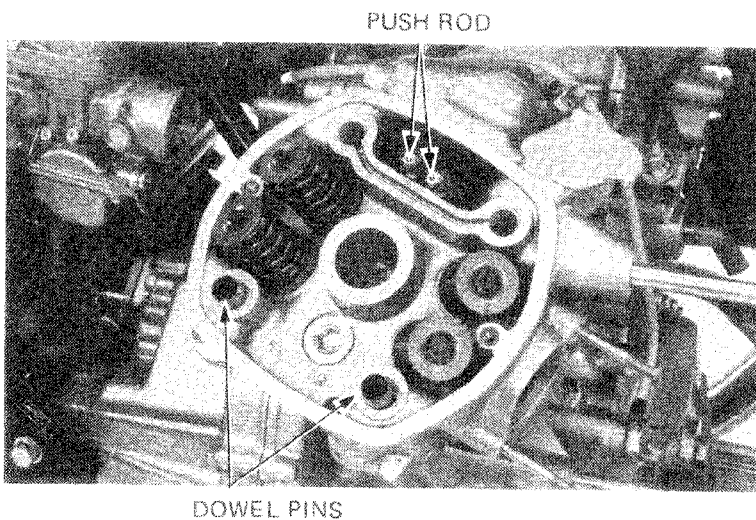

Remove the cylinder base dowel pins.
Remove the oil control orifice and O-ring.
Remove the cylinder head gasket.

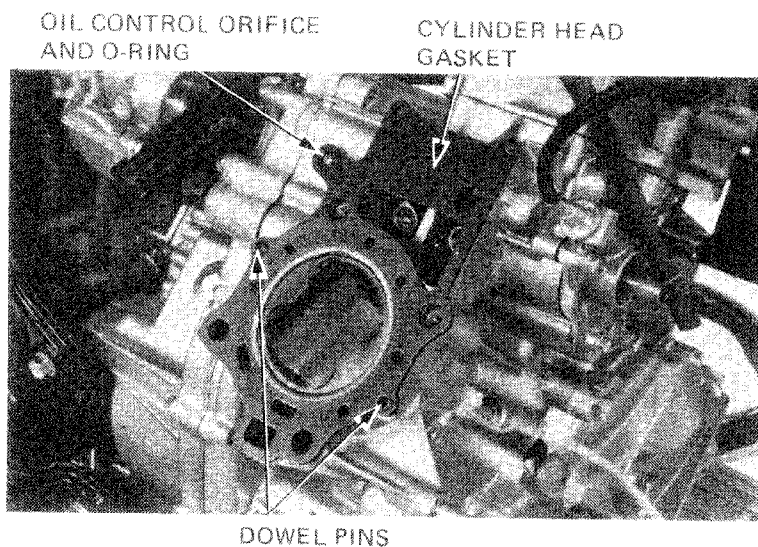

ROCKER ARM HOLDER DISASSEMBLY

Withdraw the rocker arm shafts and remove the wave washers and rocker arms.

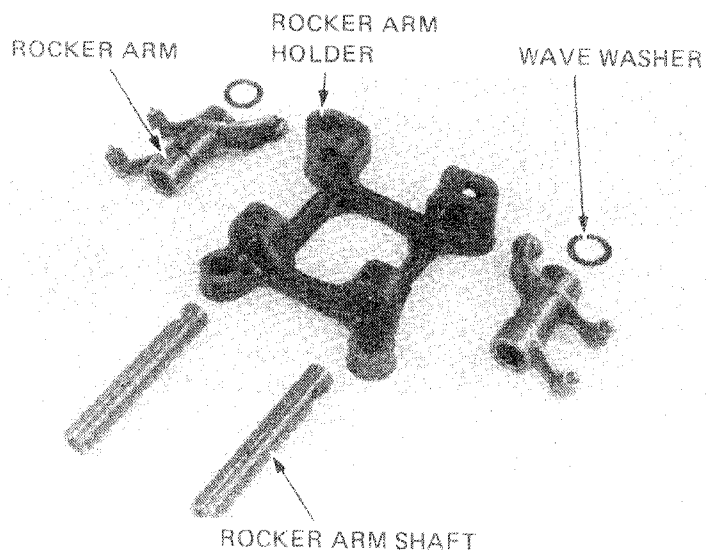

ROCKER ARM SHAFT INSPECTION

Measure the O.D. of each rocker arm shaft.
Examine the wave washers for damage.
Inspect each shaft for damage, scoring or nicks.
SERVICE LIMIT: 14.95 mm (0.589 in)

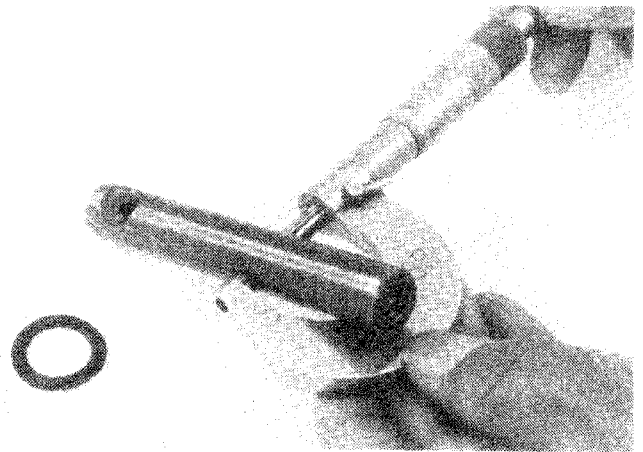

ROCKER ARM HOLDER INSPECTION

Measure the rocker arm holder I.D.
SERVICE LIMIT: 15.03 mm (0.592 in)

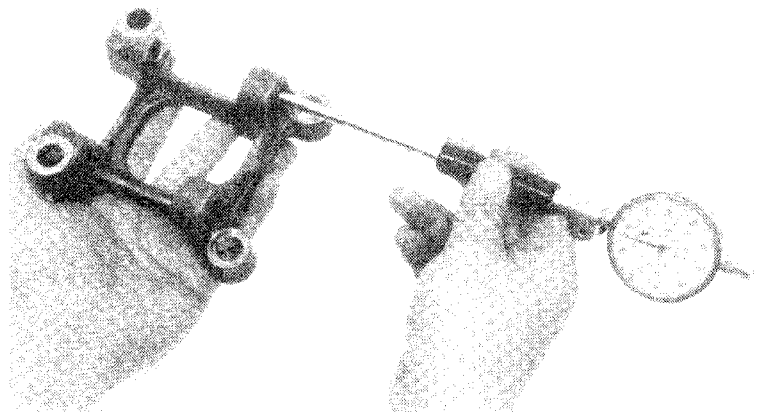

ROCKER ARM INSPECTION

Inspect each rocker arm for scoring, damage, or clogged oil holes. Measure the arm I.D. of each rocker.
SERVICE LIMIT: 15.04 mm (0.592 in)

If a rocker arm shows wear or damage to the adjusting screw or push rod contact faces, inspect the push rods and stem contact faces for scoring scratches, or evidence of insufficient lubrication. Inspect the push rods for wear, damage and trueness.

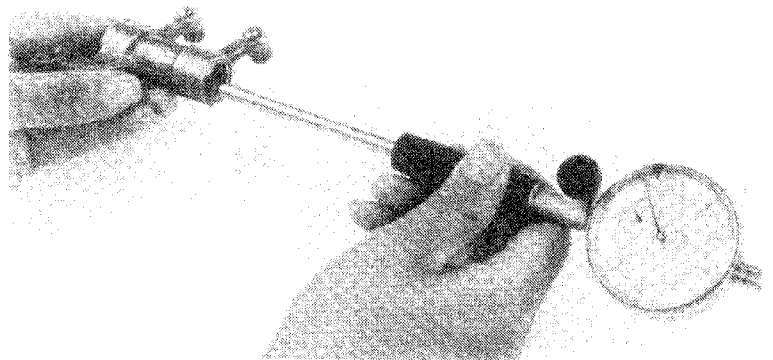



CYLINDER HEAD DISASSEMBLY

Remove the valve spring cotters, retainers, springs and valves.

NOTE

- Do not compress the valve springs more than necessary to remove the cotters.
- Mark all parts to ensure original assembly.

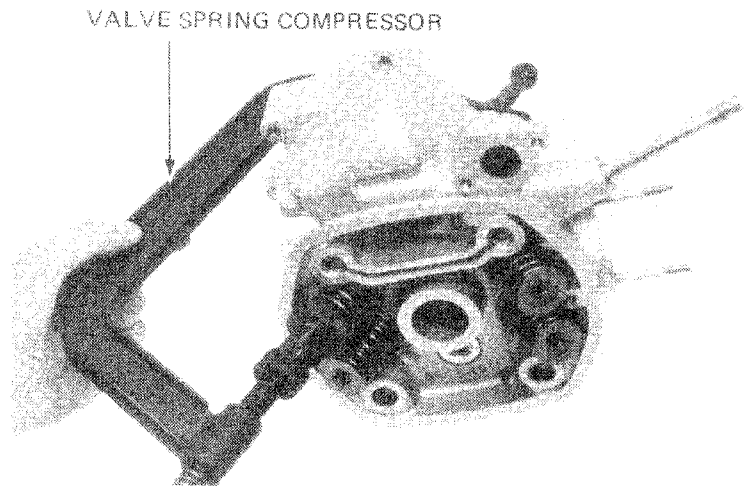

Remove carbon deposits from the combustion chamber.

Remove any gasket material from the head surfaces.

NOTE

- Do not damage the gasket surfaces.
- Avoid dropping gasket material into the jackets or oil passages.
- Gaskets will come off easier if soaked with solvent.

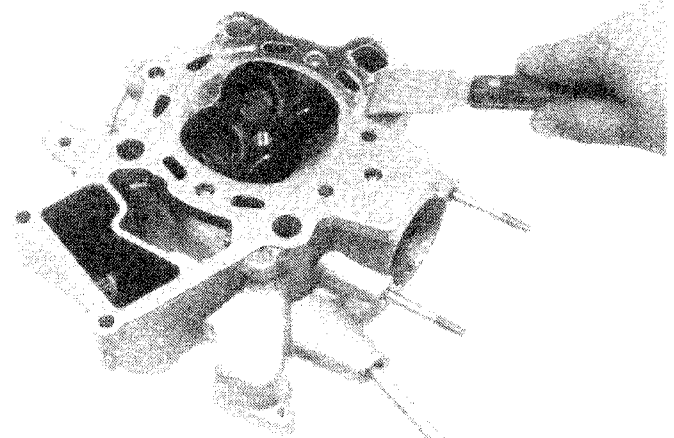

CYLINDER HEAD INSPECTION

Check the spark plug hole and valve areas carefully for cracks.

Check the cylinder head for warpage with a straight edge and a feeler gauge.

SERVICE LIMIT: 0.10 mm (0.040 in)

NOTE

- Check for warpage in an X pattern.

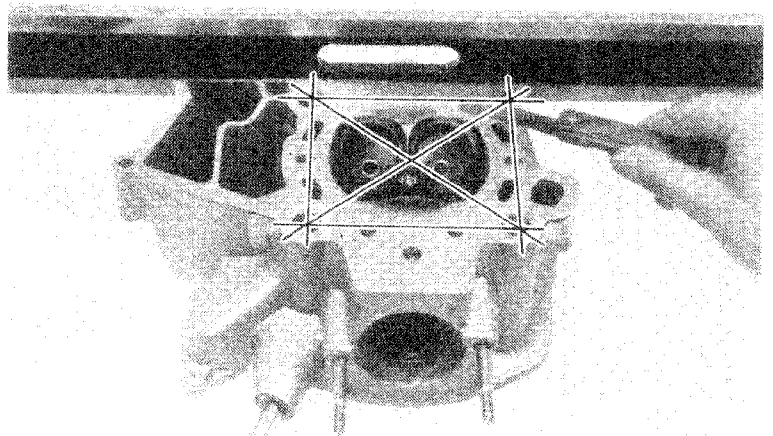



CYLINDER HEAD/VALVE

VALVE SPRING INSPECTION

Measure the free length of the inner and outer valve springs.

SERVICE LIMITS:

INNER (IN): 48.40 mm (1.905 in)

(EX): 48.40 mm (1.905 in)

OUTER (IN): 48.50 mm (1.909 in)

(EX): 48.50 mm (1.909 in)

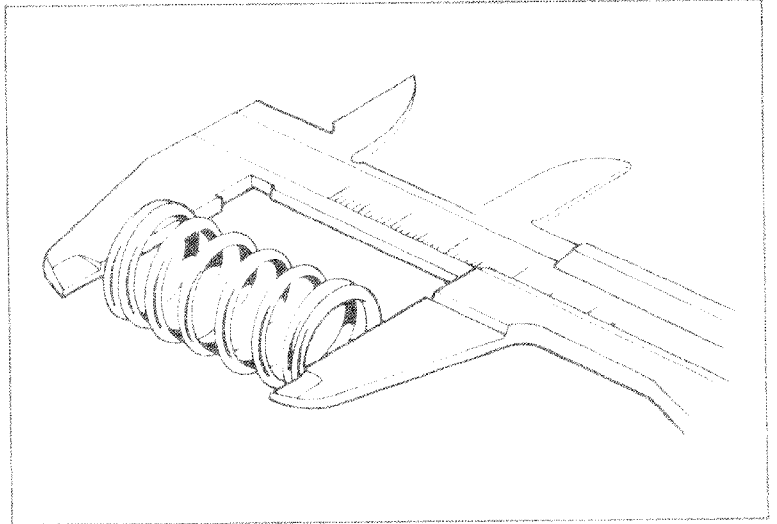

VALVE INSPECTION

Clean the valves and inspect for trueness, burring, scoring, or abnormal stem end wear.

Check the valve movement in the guide.

Measure and record each valve stem O.D.

SERVICE LIMITS:

(IN): 6.54 mm (0.258 in)

(EX): 6.54 mm (0.258 in)

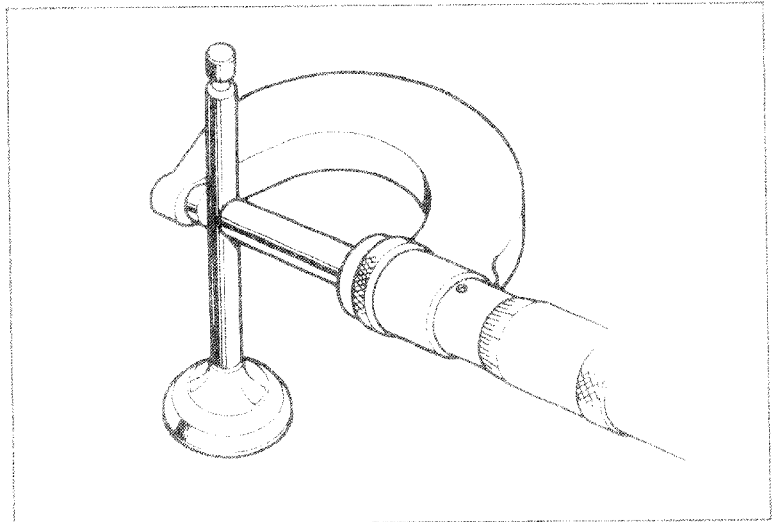

VALVE GUIDE REAMER
07984-6570100 or 07984-6110000

VALVE GUIDE INSPECTION

Ream the guides to remove any carbon build-up before checking clearance.

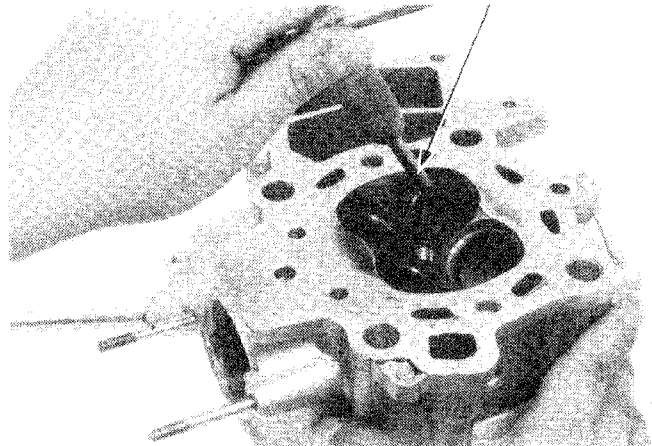



STEM-TO-GUIDE CLEARANCE INSPECTION

Measure and record each valve guide I.D. using a ball gauge or inside micrometer.

SERVICE LIMITS:

(IN/EX): 6.70 mm (0.264 in)

Calculate the stem to guide clearance.

SERVICE LIMITS:

(IN): 0.10 mm (0.040 in)

(EX): 0.10 mm (0.040 in)

NOTE

If the stem to guide clearance exceeds the service limit, determine if a new guide with standard dimensions would bring the clearance within tolerance.
If so, replace guides as necessary and ream to fit.

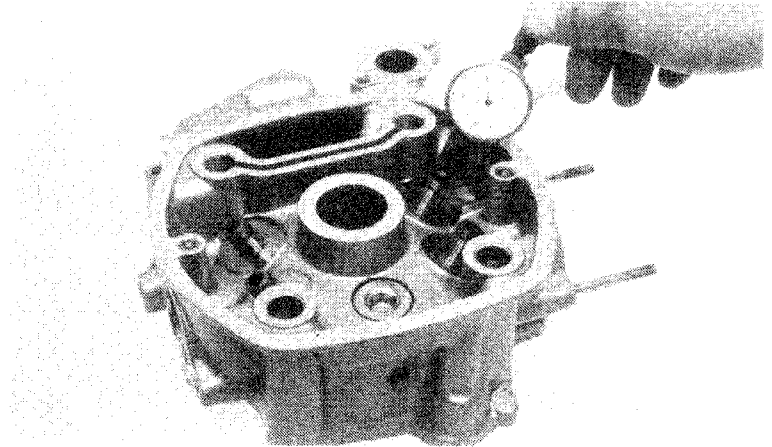

VALVE GUIDE REPLACEMENT

If the stem-to-guide clearance still exceeds the service limits with new guides, replace the valves and guides.

NOTE

Do not damage the cylinder head when replacing valve guides.

Support the cylinder head and drive out the guide from the valve port.

VALVE GUIDE REMOVER 07942-6570100

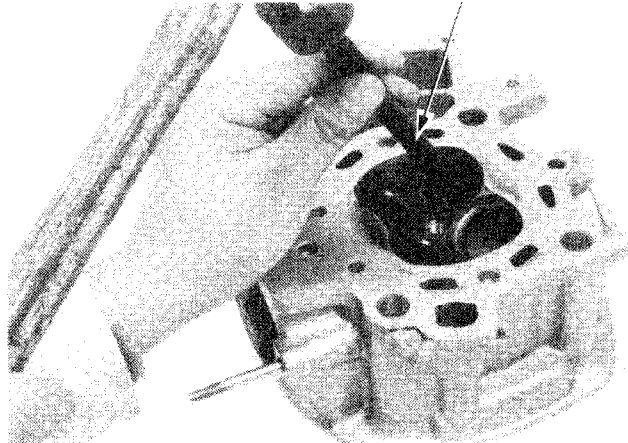

VALVE GUIDE REMOVER 07942-6570100

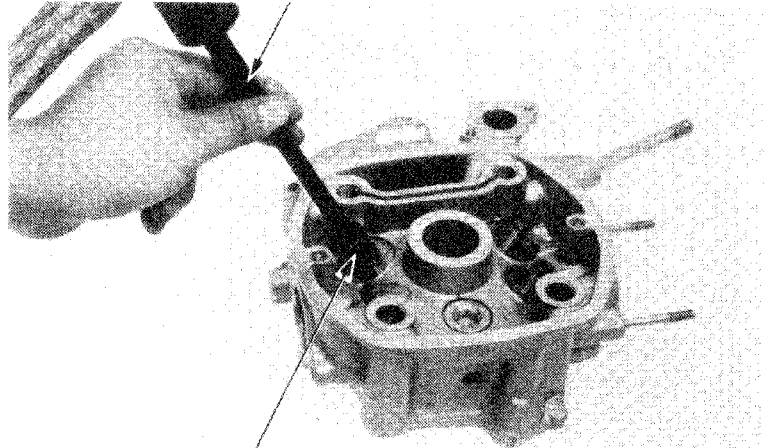

ATTACHMENT 07943-4150000

Place the ATTACHMENT on the VALVE GUIDE REMOVER. Drive the guides into place from the top of the head.



CYLINDER HEAD/VALVE

VALVE GUIDE REAMER
07984-6570100 or 07984-6110000

Ream the new valve guides after installation.

NOTE

- Use cutting oil on the reamer during this operation.
- It is important that the reamer be rotated when it is inserted or removed.
- Clean the head thoroughly of any particles.

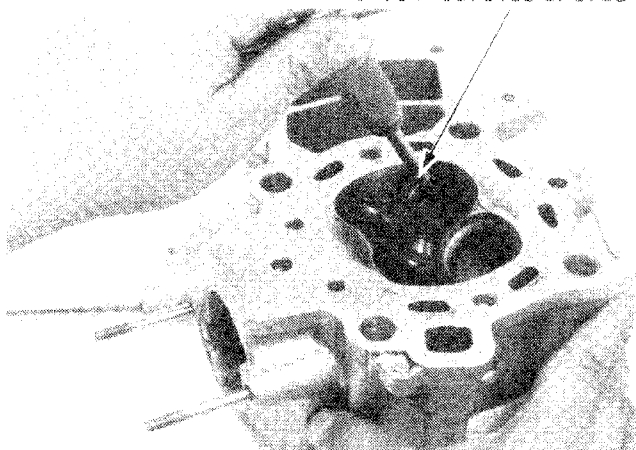

VALVE SEAT INSPECTION AND GRINDING

Clean all intake and exhaust valves thoroughly to remove carbon deposits.

Apply a light coating of Prussian Blue to each valve seat. Lap each valve and seat using a rubber hose or other hand-lapping tool.

Remove and inspect each valve.

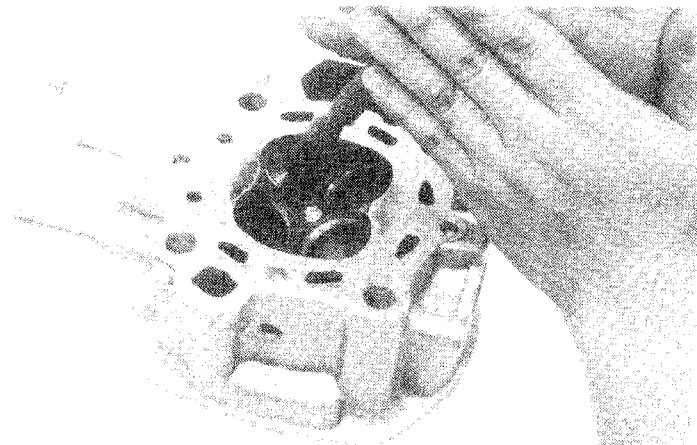

CAUTION

The valve cannot be ground. If the valve face is burned or badly worn or if it contacts the seat unevenly, replace the valve.

Inspect each valve seat width.

STANDARD:	1.1 – 1.3 mm (0.04 – 0.05 in)
SERVICE LIMIT:	2.0 mm (0.08 in)

If the seat is too wide, too narrow or has low spots, the seat must be ground.

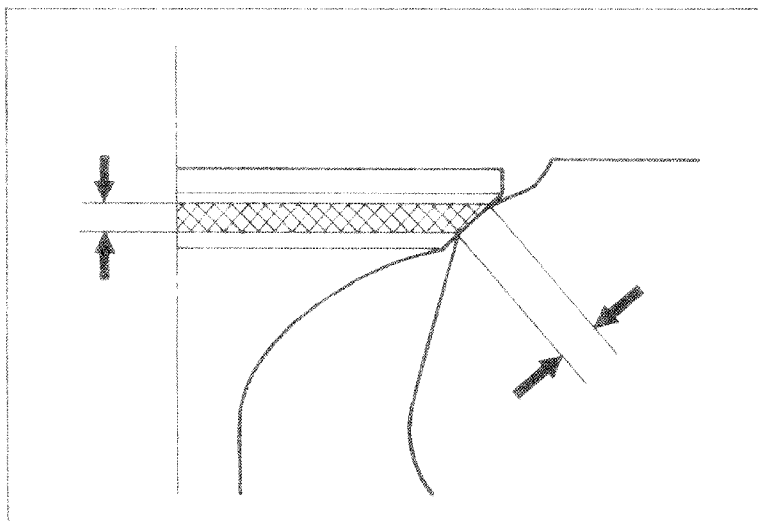



VALVE SEAT CUTTERS

HONDA VALVE SEAT CUTTERS, grinder or equivalent valve seat refacing equipment are recommended to correct a worn valve seat.

NOTE

- Follow the refacer manufacturer's operating instructions.
- Honda valve seat cutters are not available in U.S.A.

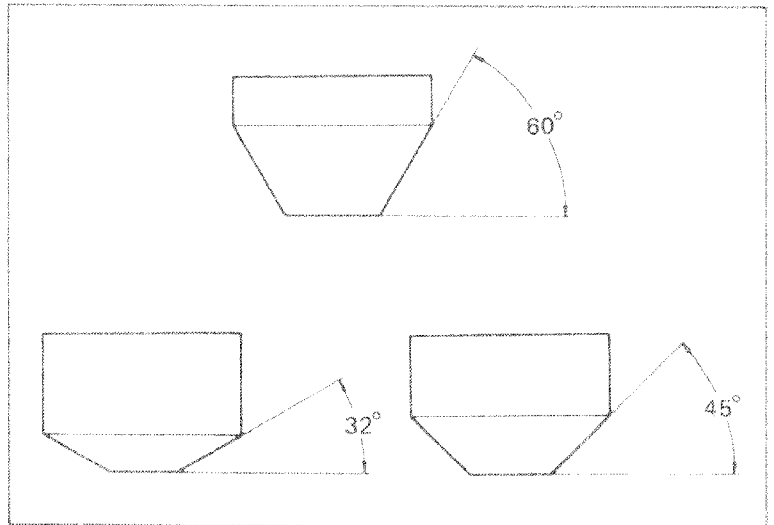

VALVE SEAT REFACING

Use a 45 degree cutter to remove any roughness or irregularities from the seat.

NOTE

- Reface the seat with a 45 degree cutter when the valve guide is replaced.

Use a 32 degree cutter to remove the top 1/4 of the existing valve seat material.

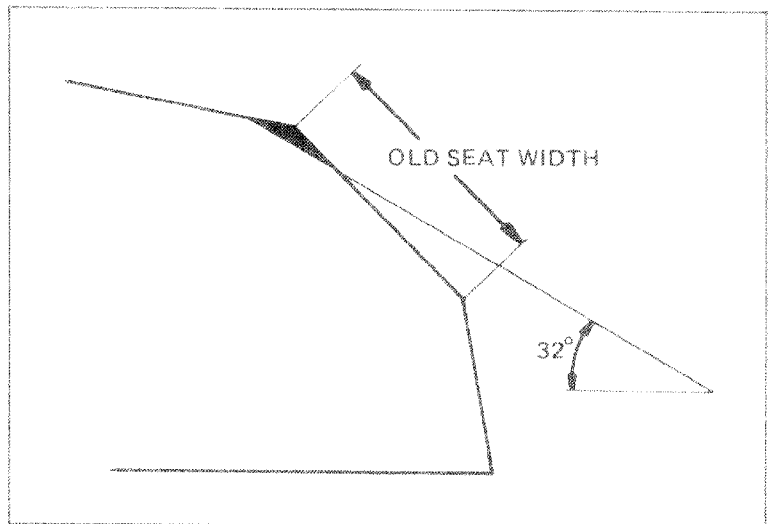

Use a 60 degree cutter to remove the bottom 1/4 of the old seat. Remove the cutter and inspect the area you have just removed.

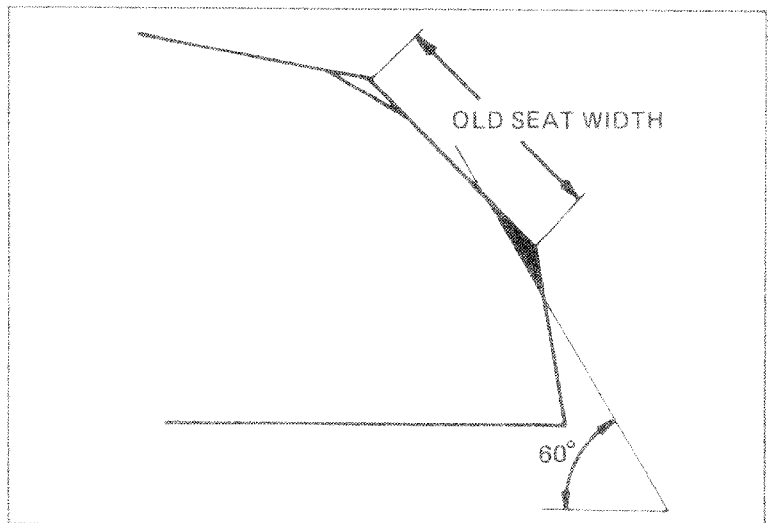



CYLINDER HEAD/VALVE

Install a 45 degree finish cutter and cut the seat to the proper width.

NOTE

Make sure that all pitting and irregularities are removed. Refinish if necessary.

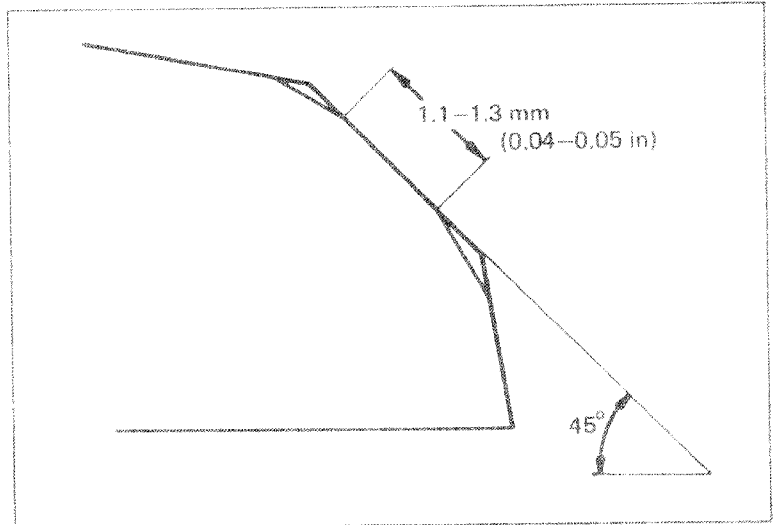

Apply a thin coating of Prussian Blue to the valve seat. Press the valve through the valve guide and onto the seat to make a clear pattern.

NOTE

The location of the valve seat in relation to the valve face is very important for good sealing.

If the contact area is too high on the valve, the seat must be lowered using a 32 degree flat cutter.

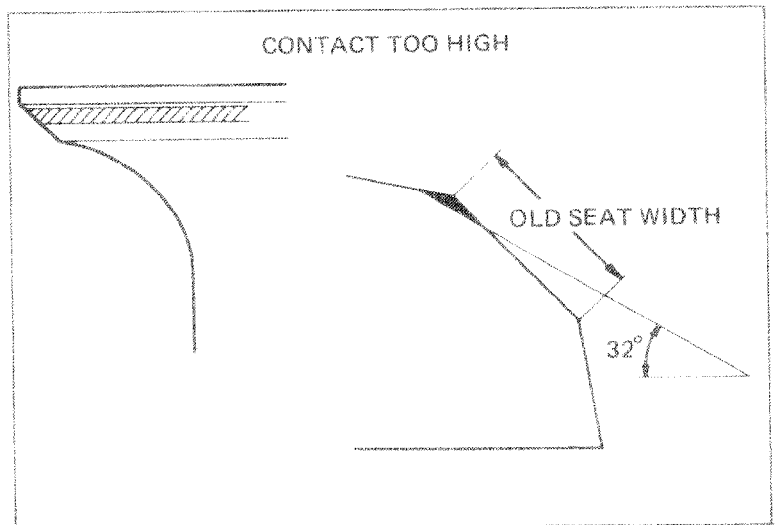

If the contact area is too low on the valve, the seat must be raised using a 60 degree inner cutter.

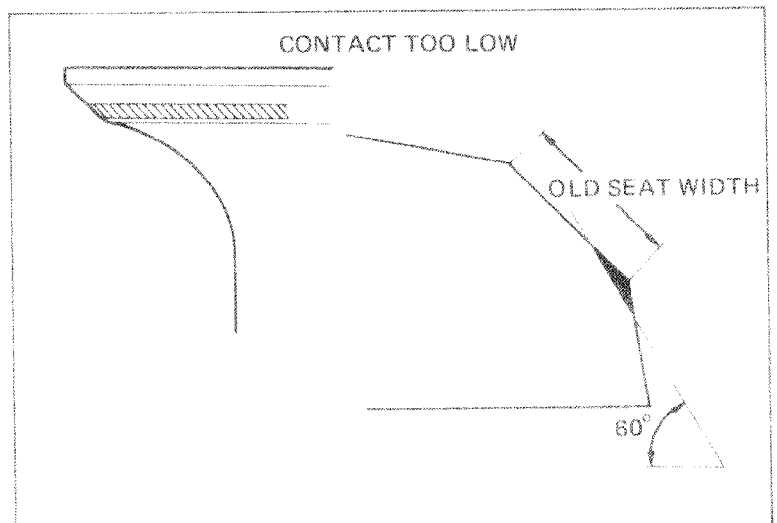



Refinish the seat to specifications, using a 45 degree finish cutter.

After cutting the seat, apply lapping compound to the valve face, and lap the valve using light pressure. After lapping, wash all residual compound off the cylinder head and valve.

NOTE

Do not allow lapping compound to enter the guides.

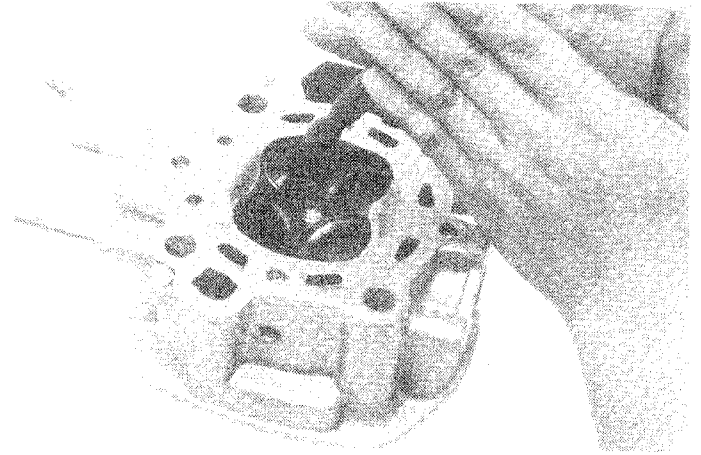

CYLINDER HEAD ASSEMBLY

Install the valve stem seals and spring seats.
Lubricate the valve stems with oil, and insert the valves into the guides.
Install the valve springs and retainers.

NOTE

- Install the valve springs with the tightly wound coils facing the head.
- Replace the stem seals with new ones whenever disassembled.

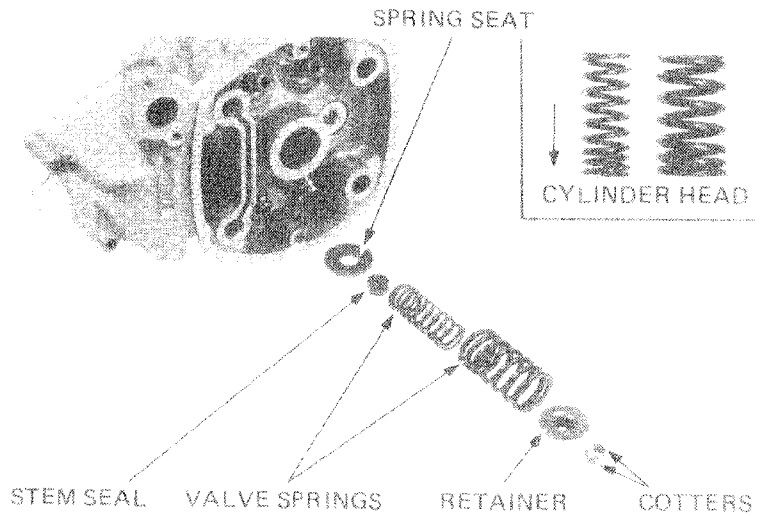

Install the valve cotters.

CAUTION

To prevent loss of tension, do not compress the valve spring more than necessary.

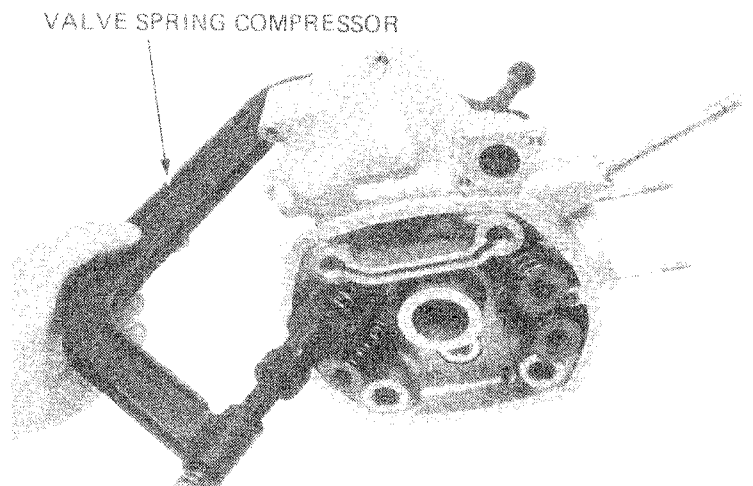



CYLINDER HEAD/VALVE

Tap the valve stems gently with a soft hammer to firmly seat the cotters.

NOTE

Support the cylinder head above the work bench surface to prevent damage.

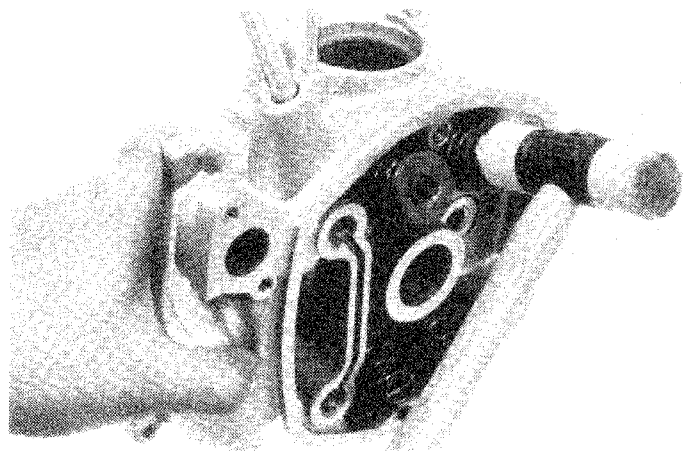

ROCKER ARM ASSEMBLY

Assemble the rocker arms, shafts and wave washers.

NOTE

- Note the rocker arm shaft direction.
- Apply oil to each shaft before assembly.

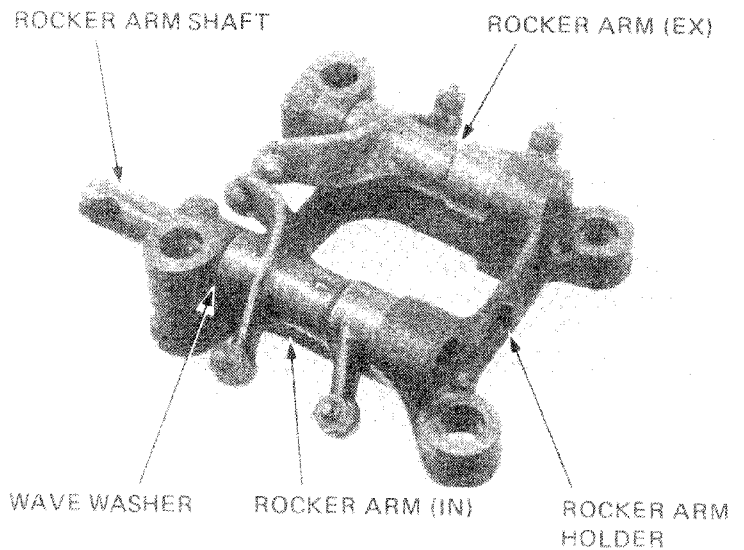

CYLINDER HEAD/ROCKER ARM INSTALLATION

Clean the cylinder surfaces of any gasket material.

NOTE

Do not damage the gasket surfaces.

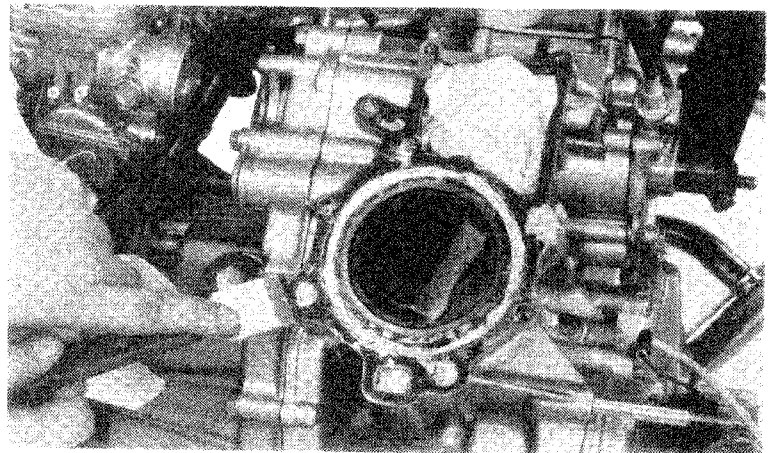



Install the O-rings and cylinder base dowel pins.
Coat the cylinder and head surfaces with liquid sealer, and install the head gasket.
Make sure that the oil orifices are not obstructed by the gaskets.
Install the cylinder drain bolts.
Remove the timing inspection cap.
Check the timing mark to be certain that the cylinder to be serviced is at T.D.C. on the compression stroke.

NOTE

- Align the index mark with the "TR" mark for the right cylinder.
- Align the index mark with the "TL" mark for the left cylinder.

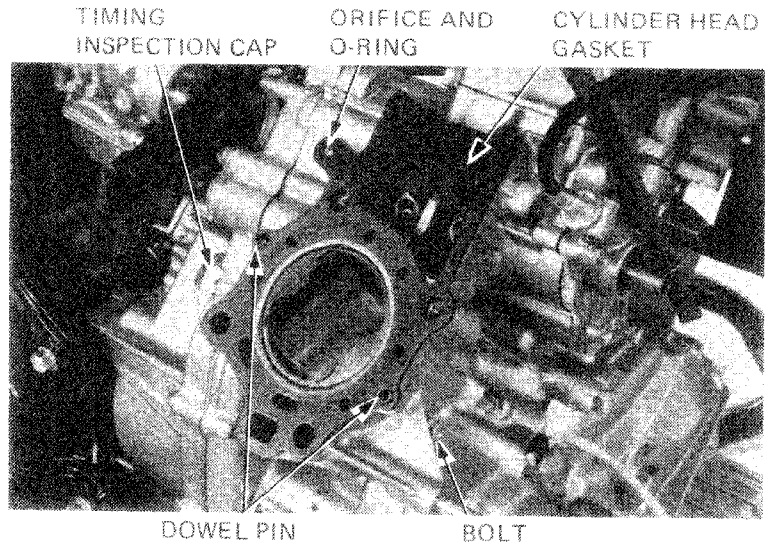

Install each cylinder head.
Install the cylinder head dowel pins.
Install the push rods into the rocker arm retainers.

NOTE

- Apply MULTIPURPOSE NLGI No. 2 (MoS₂ additive) GREASE to the end of each push rod.

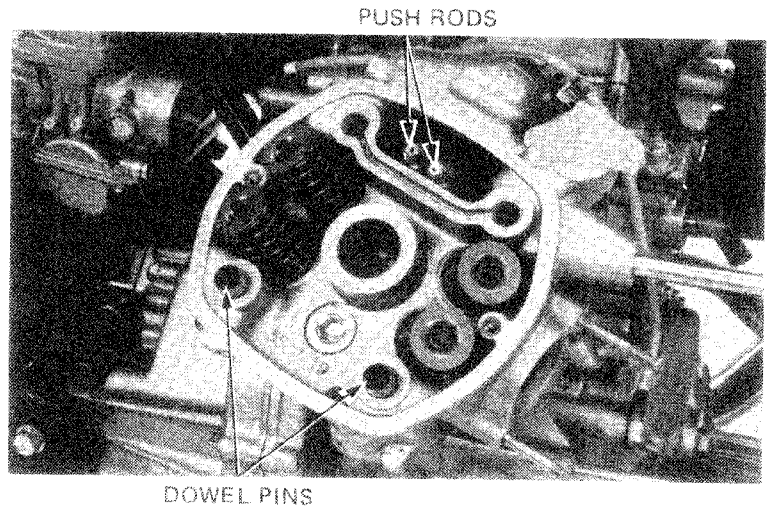

Install the rocker arm holder assembly.
Align the rocker arms with the push rods.

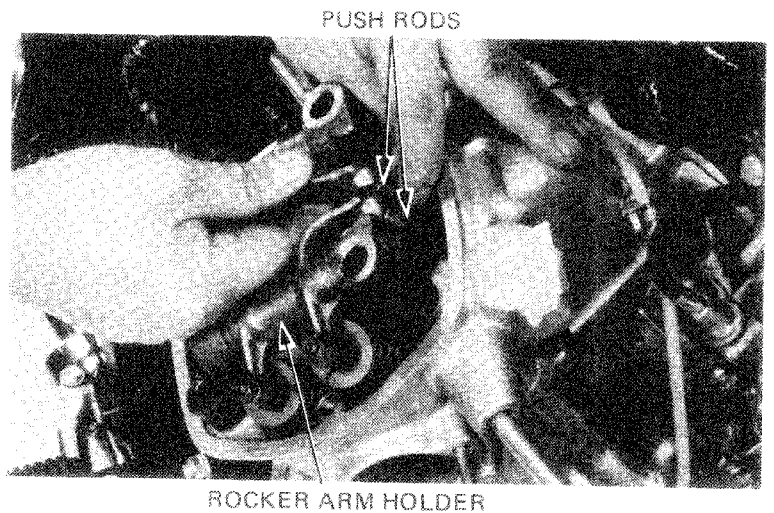



CYLINDER HEAD/VALVE

Tighten the cylinder head bolts in 2–3 steps in a crisscross pattern.

TORQUE: 50–60 N·m
(5.0–6.0 kg·m, 36–43 ft·lb)

Check the valve clearance (Page 3–7) and adjust if necessary.

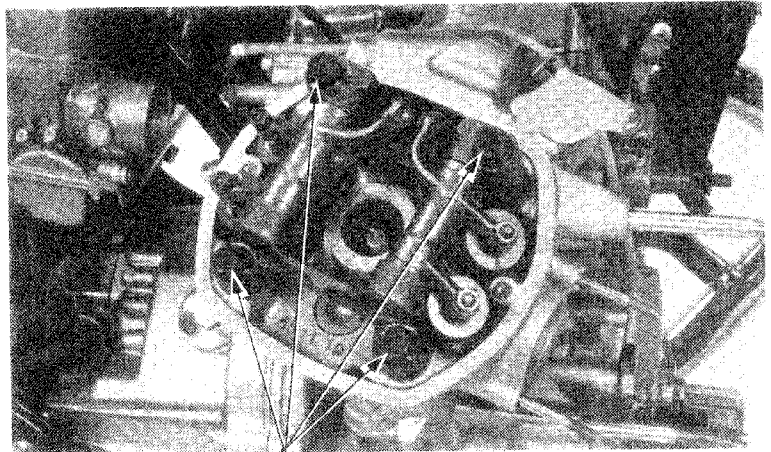

CYLINDER HEAD BOLTS

Install the cylinder head cover and connect the spark plug caps.

Install the air spoiler and thermostat unit (Page 9–8).

Install the water pipes and pipe joints.

NOTE

Make sure that the O-rings are not deteriorated or damaged.

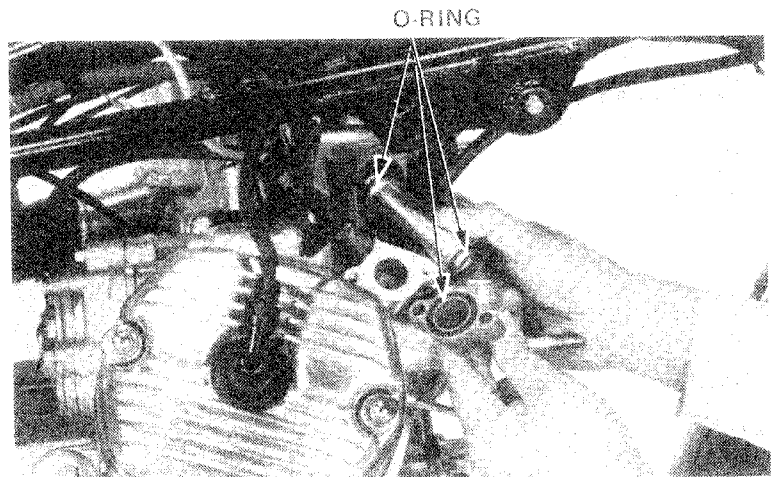

O-RING

Install the carburetor intake pipe and exhaust pipe. Install the front engine hanger.

TORQUE:

10 mm bolt:	45–70 N·m (4.5–7.0 kg·m, 33–51 ft·lb)
12 mm bolt:	60–80 N·m (6.0–8.0 kg·m, 43–58 ft·lb)

Install the cooling fan cover.

TORQUE: 30–40 N·m
(3.0–4.0 kg·m, 22–29 ft·lb)

Install the cooling fan and radiator (Page 10–7).
Fill the cooling system with the recommended coolant (Page 9–3).

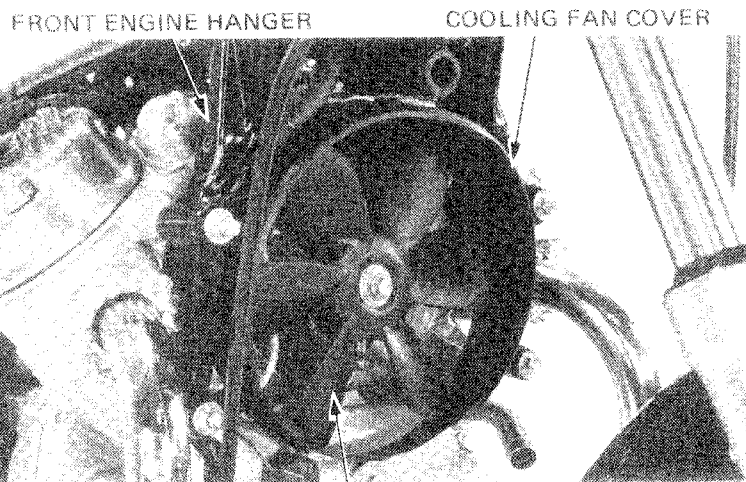

FRONT ENGINE HANGER

COOLING FAN COVER

COOLING FAN



HONDA
GL500
GL500 INTERSTATE

MEMO



CLUTCH/OIL PUMP

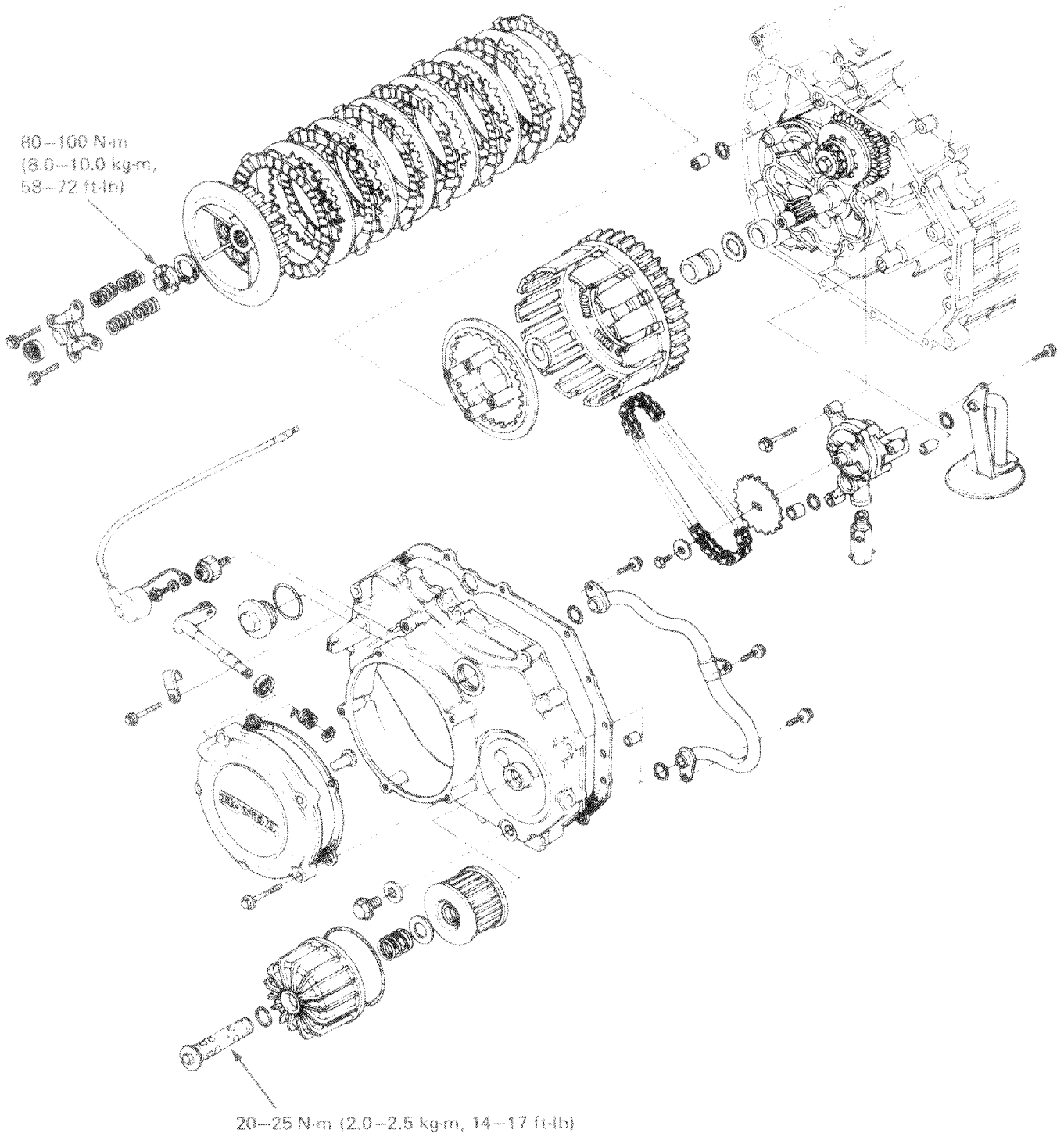



7. CLUTCH/OIL PUMP

SERVICE INFORMATION	7-1
TROUBLESHOOTING	7-1
CLUTCH REMOVAL	7-2
CLUTCH INSTALLATION	7-5
OIL PUMP REMOVAL	7-9
OIL PUMP INSTALLATION	7-12

SERVICE INFORMATION

GENERAL INSTRUCTIONS

- Clutch discs, plates "A" and "B", clutch center, and clutch plates can be serviced by removing the clutch cover.
- To service the oil pump, it is necessary to remove the radiator and transmission cover.
- All these operations can be accomplished with the engine in the frame.

TOOLS

Special

Clutch center holder : 07923-4150000

Common

Lock nut socket wrench 26 x 30 mm : 07716-0020202

Extension : 07716-0020500 Equivalent tool commercially available in U.S.A.

SPECIFICATIONS

Item		Standard	Service Limit	
Clutch	Lever free play (at lever end)	10-20 (3/8-3/4)	—	
	Clutch spring	Free length	33.90 (1.335)	32.5 (1.28)
		Tension	19.7-22.3 kg/23.5 mm (43.4-49.2 lbs/0.93 in)	18.0 kg/23.5 mm (39.7 lbs/0.93 in)
	Disc thickness	A	2.7 (0.11)	2.3 (0.091)
		B	3.5 (0.14)	3.1 (0.122)
	Plate warpage	A	—	0.20 (0.008)
		B	—	0.20 (0.008)
	Clutch outer I.D.	32.000-32.025 (1.2598-1.2608)	32.07 (1.263)	
	Outer guide O.D.	31.959-31.975 (1.2582-1.2589)	31.90 (1.256)	
	Oil pump	Inner-to-outer rotor clearance	—	0.10 (0.004)
Outer rotor-to-body clearance		—	0.35 (0.014)	
Rotor-to-body clearance		—	0.10 (0.004)	
Oil pressure relief valve relief pressure		500-600 kPa (5.0-6.0 kg/cm ² , 71-85 psi)	—	

TROUBLESHOOTING

Oil Pump

- Refer to page 2-1 for oil pump troubleshooting.

Clutch

- Faulty clutch operation can usually be corrected by adjusting the free play.

Clutch Slips When Accelerating

- No free play
- Discs worn
- Springs weak

Clutch Will Not Disengage

- Too much free play
- Plates warped

Clutch Chatters or Rattles

- Worn clutch outer and disc splines

Motorcycle Creeps with Clutch Disengaged

- Too much free play
- Plates warped

Excessive Lever Pressure

- Clutch cable kinked, damaged or dirty
- Lifter mechanism damaged

Clutch Operation Feels Rough

- Outer drum slots rough
- Disc plate wave spring weak or damaged

CLUTCH REMOVAL

Drain the oil from engine.
Disconnect the clutch cable at the lower adjuster.
Remove the clutch cover.

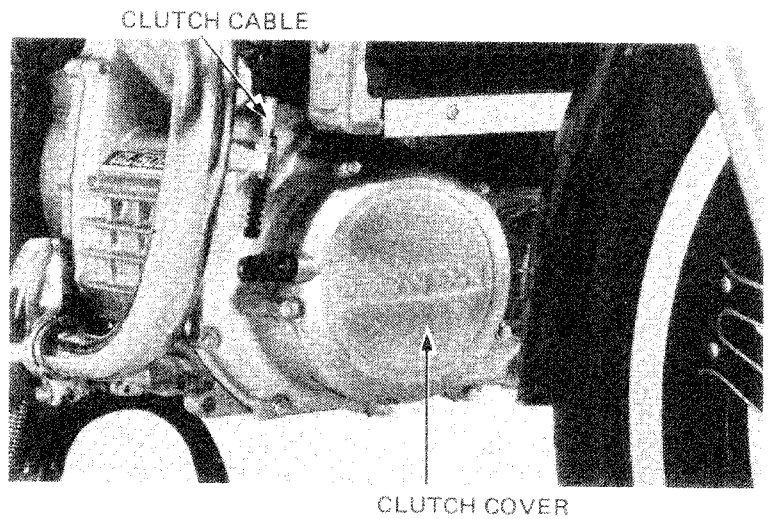

CLUTCH LIFTER REMOVAL

Remove the lifter piece, circlip, spring, clutch lever and O-ring.

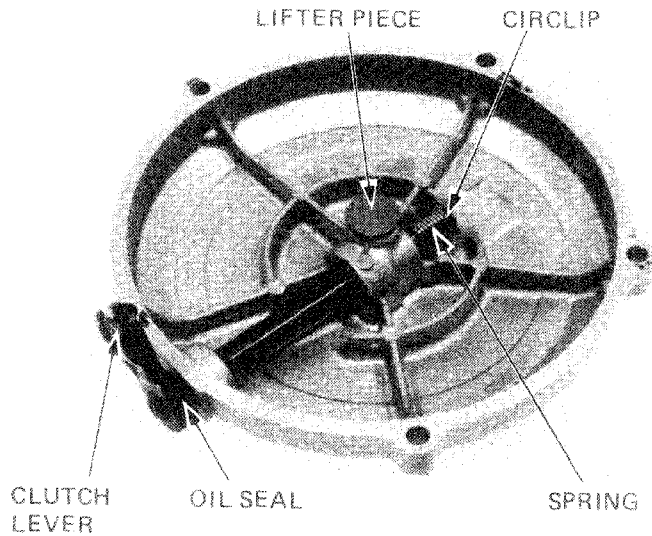

CLUTCH LIFTER PLATE REMOVAL

Remove the bolts, springs and lifter plate.

NOTE

Loosen the bolts in an crisscross pattern in two or more steps.

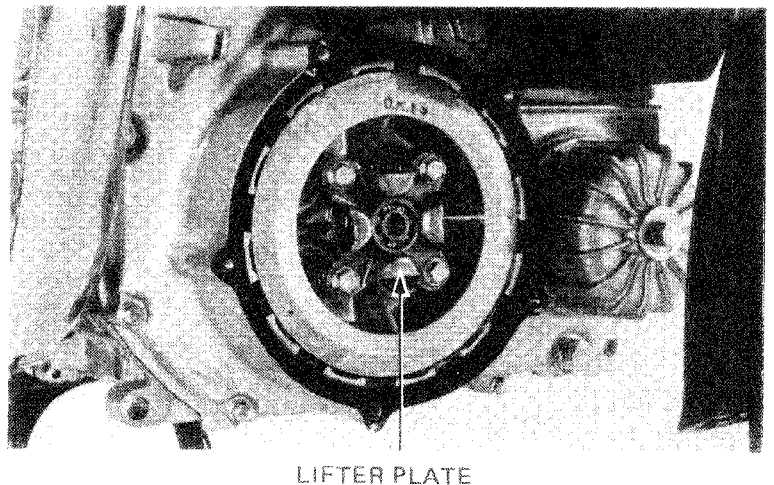



CLUTCH REMOVAL

Attach the CLUTCH CENTER HOLDER onto the pressure plate boss with four bolts.

NOTE

Tighten the bolts finger tight.

CAUTION

Damage to the pressure plate will occur if the clutch center holder is not attached with 4 bolts.

Remove the lock nut and lock washers.

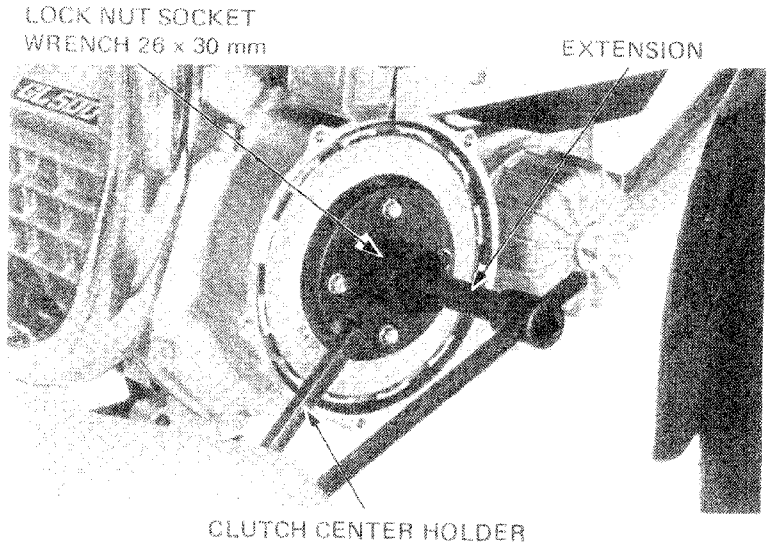

Remove the pressure plate, discs "A" and "B", disc plate, and clutch center as a unit.

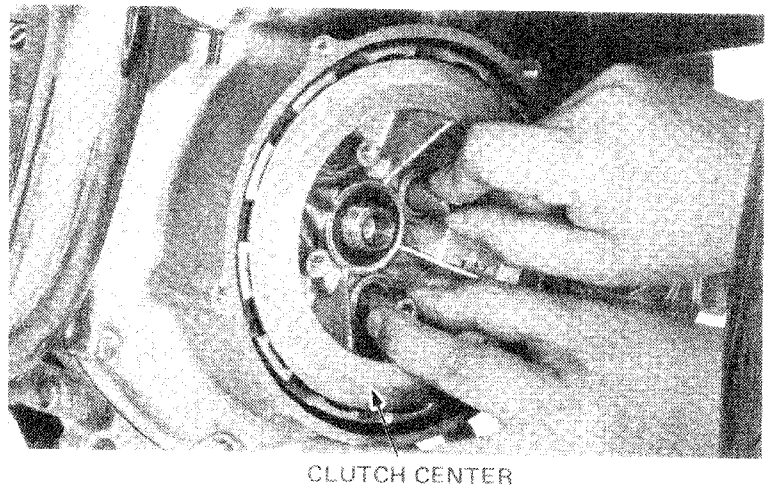

Remove the thrust washer and clutch outer.
Remove the clutch outer guide, thrust washer and collar.

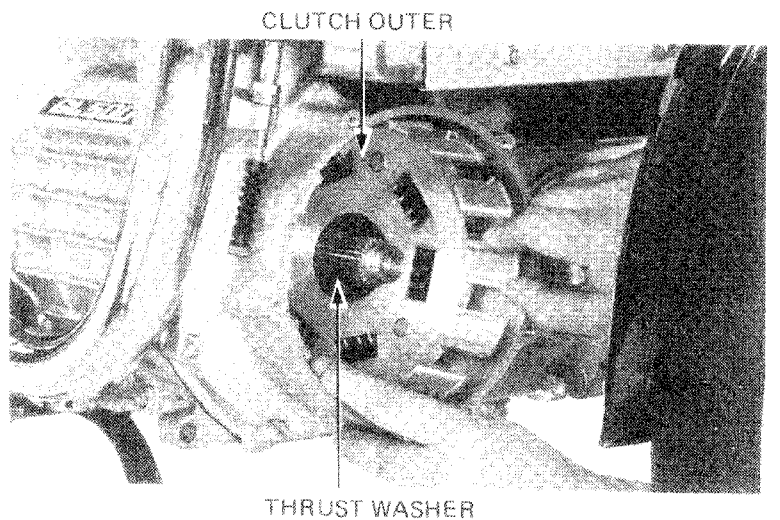

CLUTCH DISC INSPECTION

Replace the clutch discs if they show signs of scoring or discoloration.

Measure the disc thickness.

SERVICE LIMITS:

Disc A: 2.30 mm (0.091 in)

Disc B: 3.10 mm (0.122 in)

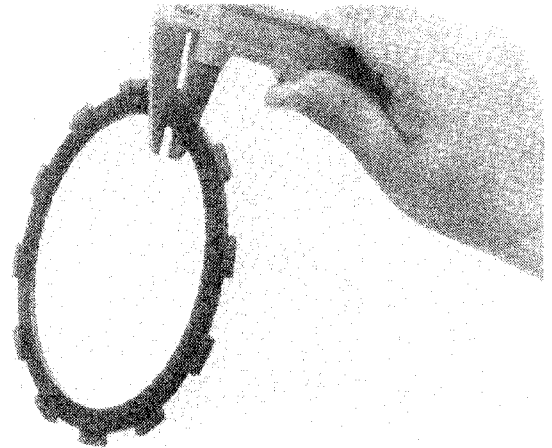

CLUTCH PLATE INSPECTION

Check for plate warpage on a surface plate, using a feeler gauge.

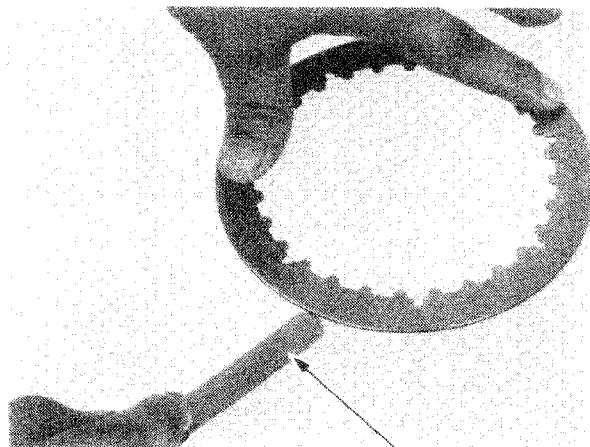

FEELER GAUGE

CLUTCH PLATE B INSPECTION

Check the wave spring for damage.

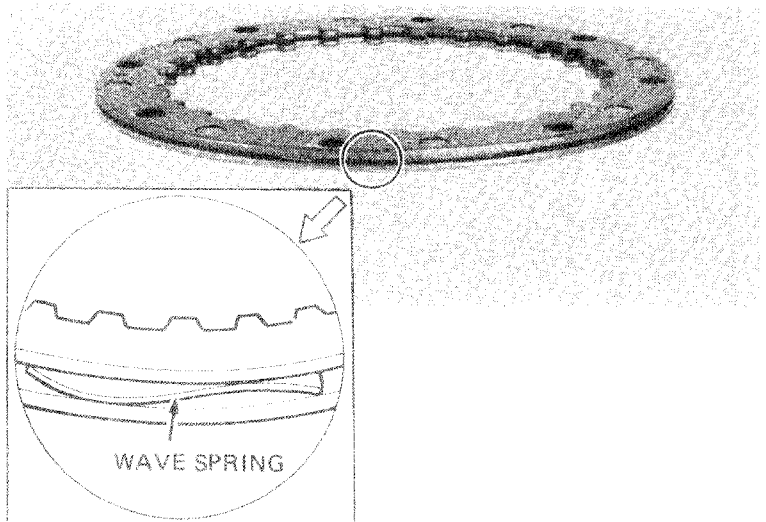

WAVE SPRING

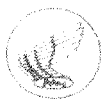

CLUTCH OUTER AND OUTER GUIDE INSPECTION

Check the slots in the outer drum for nicks, cuts or indentations made by the friction discs.

Measure the I.D. of the clutch outer and the O.D. of the outer guide.

SERVICE LIMITS:

- Outer I.D: 32.07 mm (1.263 in)
- Guide O.D: 31.90 mm (1.256 in)

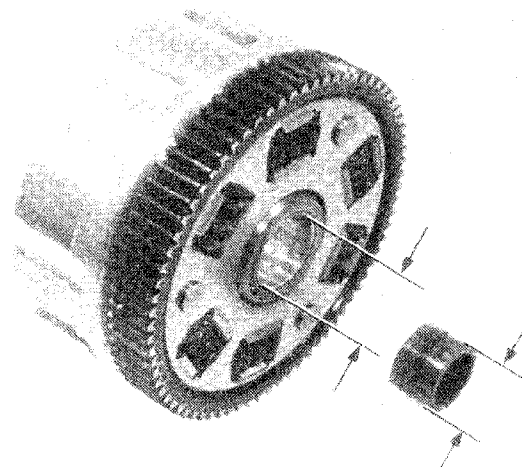

CLUTCH SPRING INSPECTION

Measure the spring free length.

SERVICE LIMIT: 32.5 mm (1.28 in)

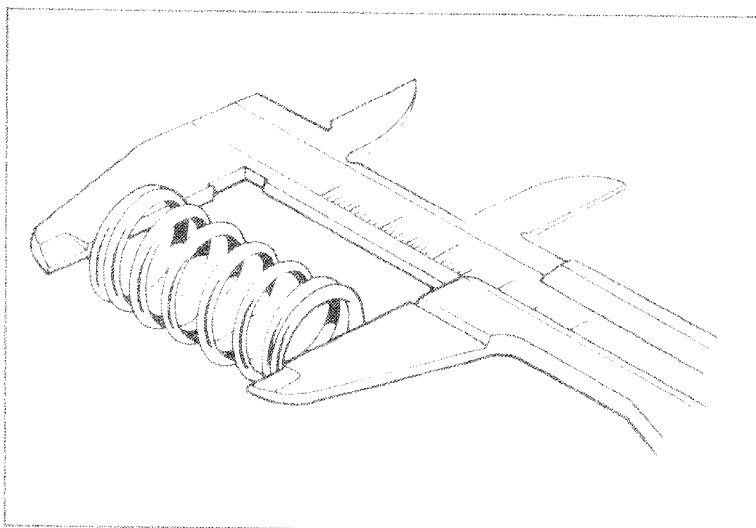

CLUTCH INSTALLATION

Install the collar, thrust washer and outer guide to the transmission mainshaft.

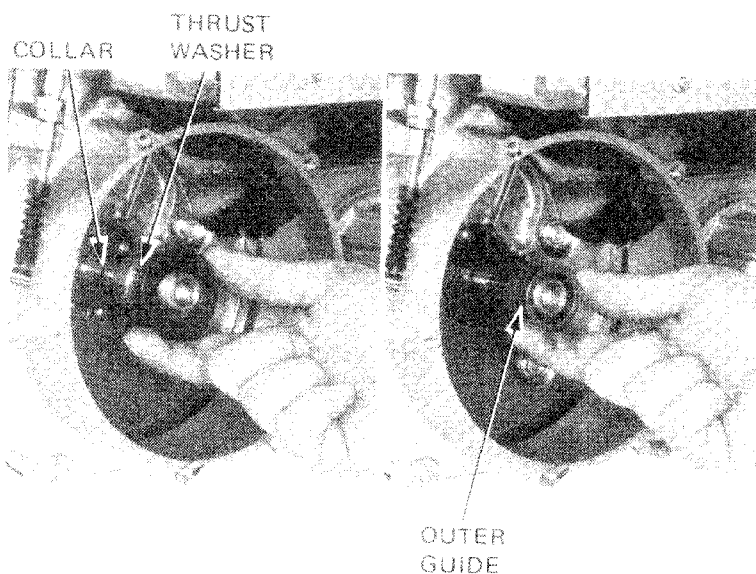



Install the clutch outer.
Install the thrust washer.

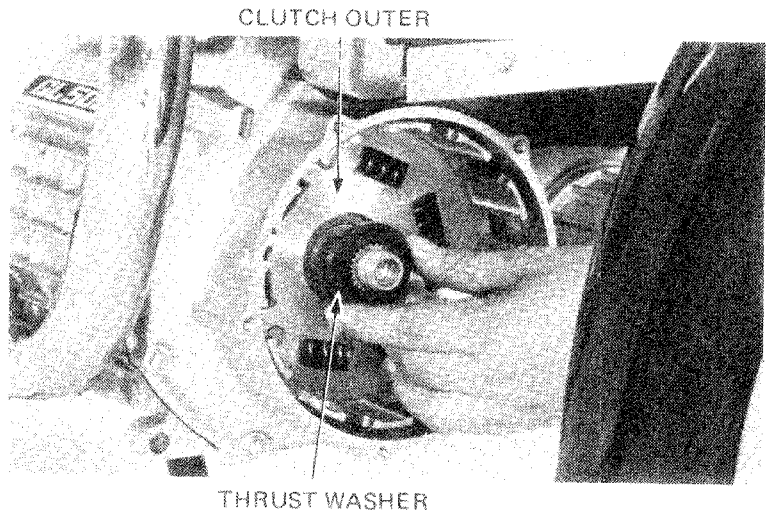

Install the pressure plate on the clutch outer.
Install the clutch plates and discs in the clutch outer as shown.

NOTE

- The disc on the pressure plate is identified by the grooves in its lining.
- The clutch disc to be placed on the pressure plate side is thinner than clutch disc B that is placed on the clutch center.

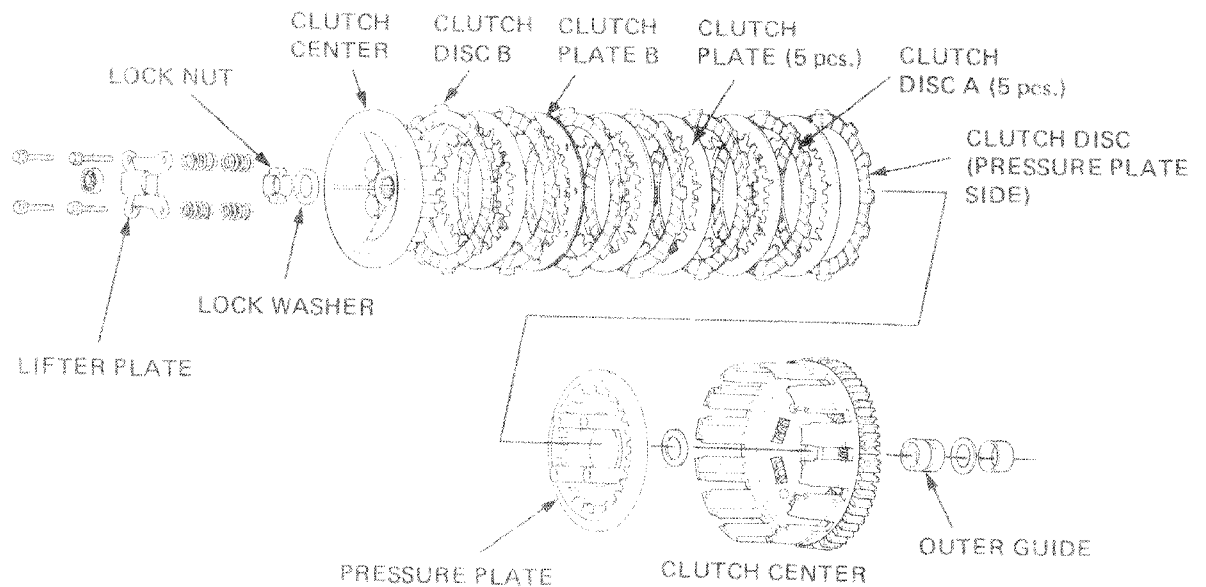
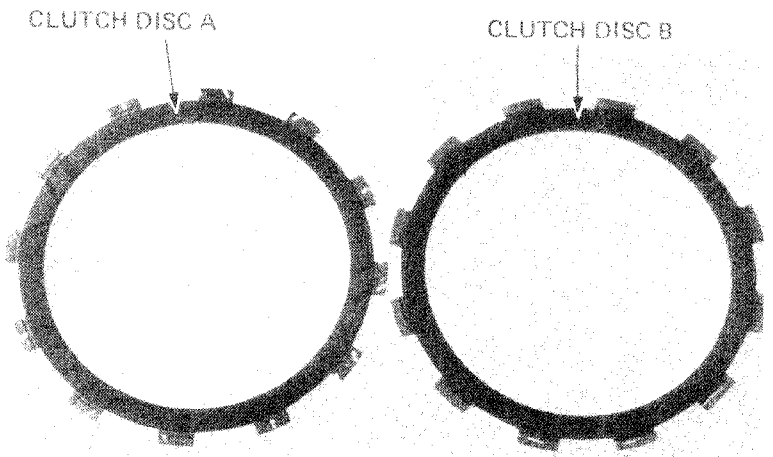



Install the clutch center, aligning the splines by rotating the clutch center.

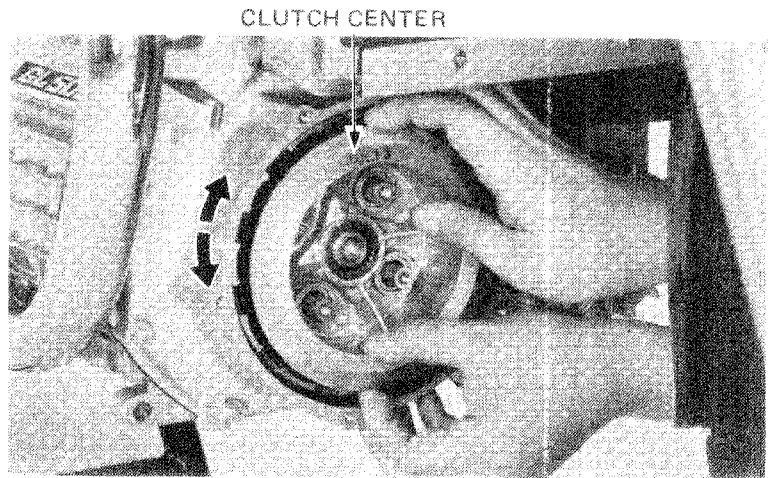

Install the clutch on the mainshaft.
Install the lock washer and lock nut.

NOTE

- Install the lock washer with the mark "OUT SIDE" facing out.
- Install the lock nut with the flat end facing out.

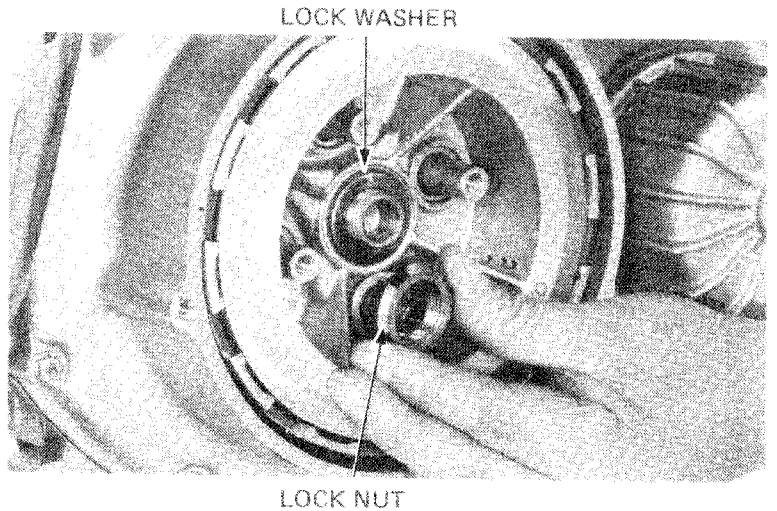

Attach the CLUTCH CENTER HOLDER to the pressure plate boss to prevent it from turning.
Tighten the lock nut.

TORQUE: 80–100 N·m
(8.0–10.0 kg·m, 58–72 ft·lb)

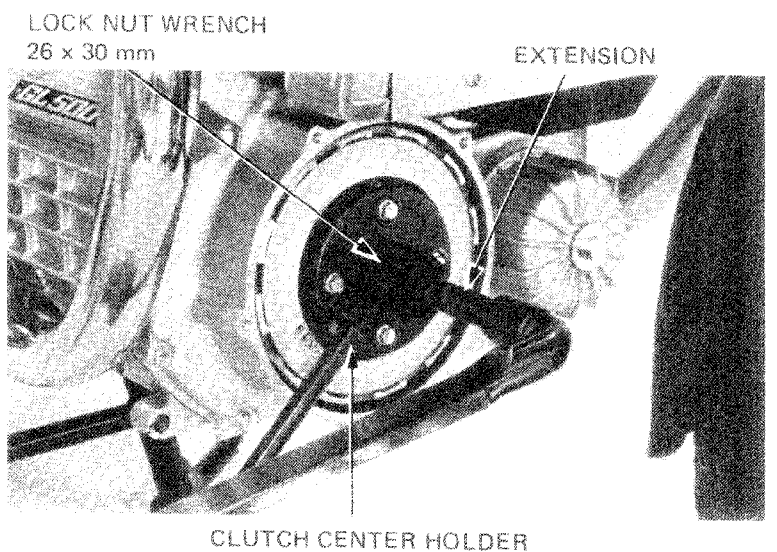



CLUTCH/OIL PUMP

Install the clutch springs and lifter plate bolts.

NOTE

Tighten the bolts evenly 2-3 steps using a crisscross pattern.

Install the clutch cover gasket.

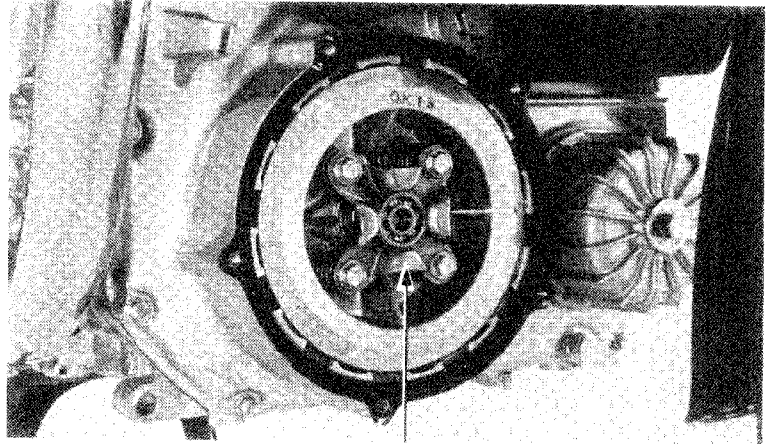

LIFTER PLATE

Install the O ring in the clutch cover.
Install the clutch lever.
Install the spring and circlip.
Rotate the clutch lever to align the hole in the lever with the hole in the clutch cover and insert the lifter piece.

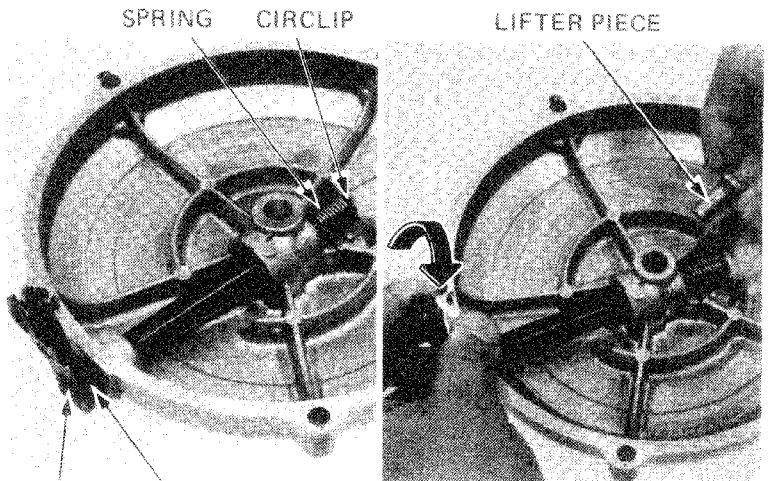

SPRING CIRCLIP

LIFTER PIECE

CLUTCH LEVER OIL SEAL

CLUTCH CABLE

Install the clutch cover.
Connect the clutch cable.
Adjust the clutch (Page 3-14).

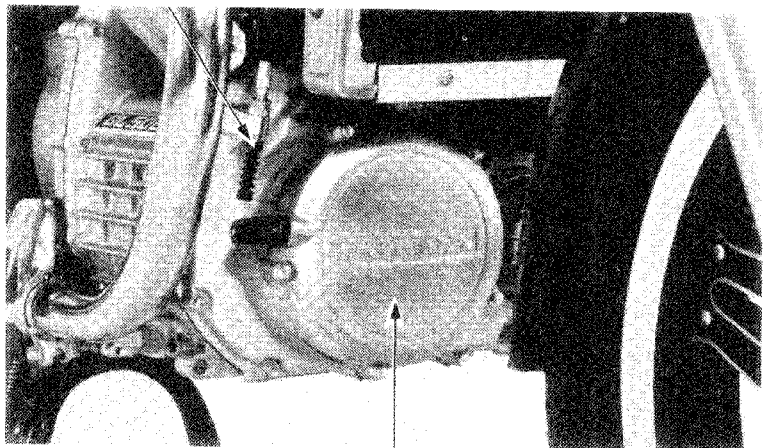

CLUTCH COVER



OIL PUMP REMOVAL

- Remove the radiator (Page 9-5).
- Remove the cooling fan and fan cover (Page 9-6).
- Remove the right front engine hanger (Page 6-3).
- Drain the oil from the engine.
- Disconnect the clutch cable at the lower end.
- Disconnect the oil pressure switch wire.
- Remove the engine front cover.

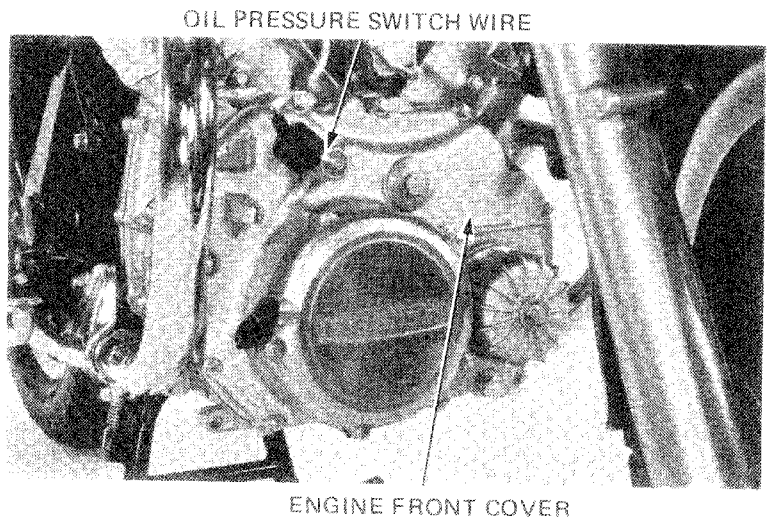

- Remove the dowel pins collars, O-rings and gasket.

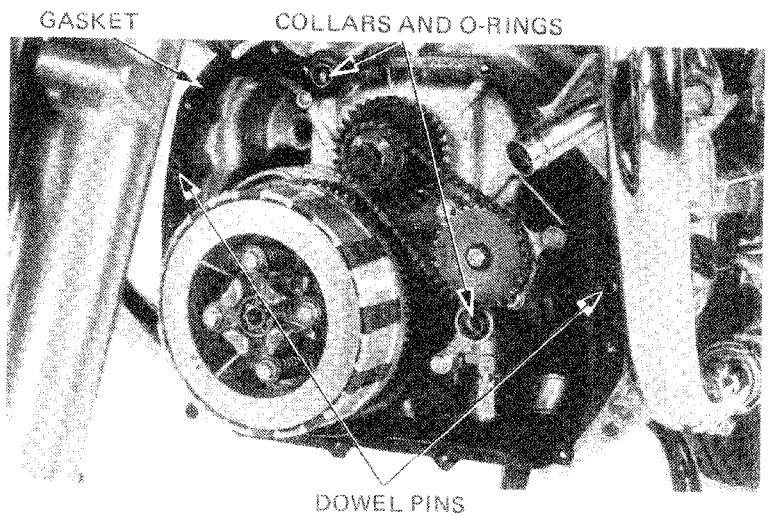

- Remove the three oil pump mount bolts and remove the oil pump with pump drive chain.

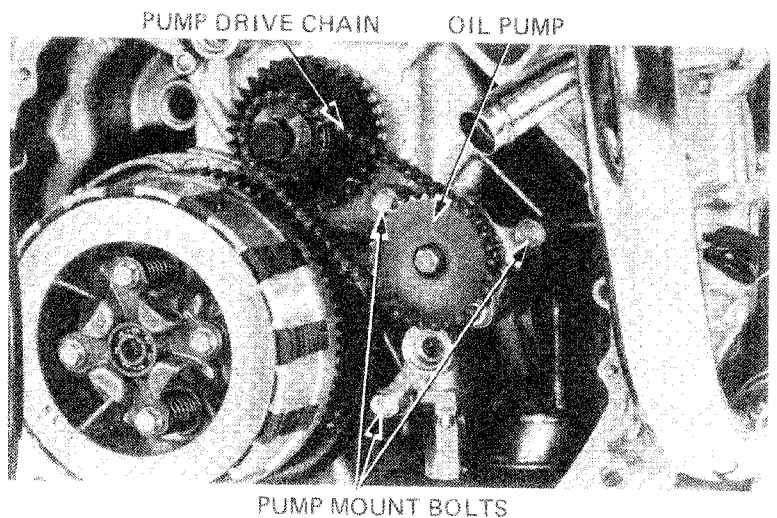

OIL PUMP DISASSEMBLY

Remove the pressure relief valve and oil strainer.
Inspect the strainer and clean with solvent.

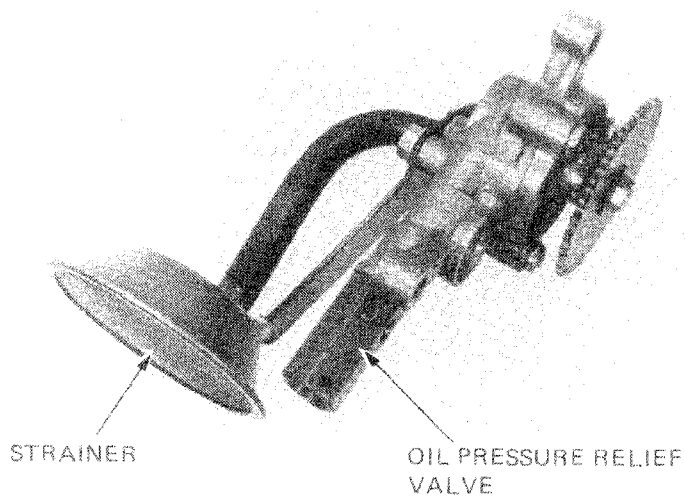

Remove the sprocket.
Remove the pump cover, thrust washer, pump shaft, and driving pin.
Remove the inner and outer rotors.

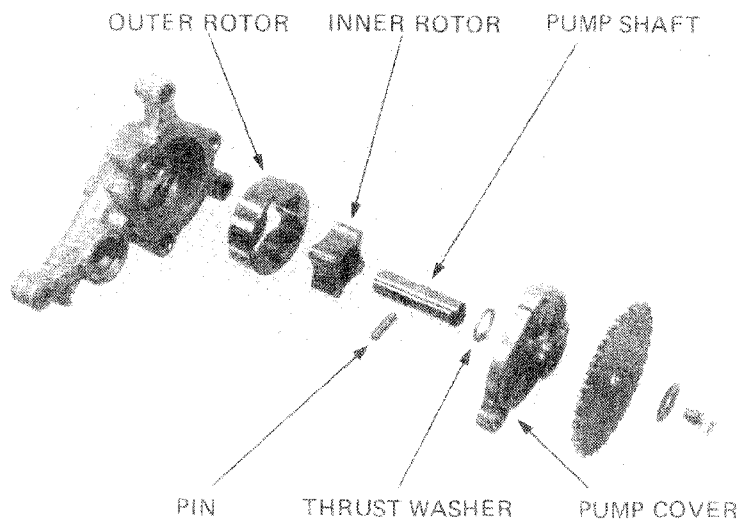

OIL PUMP INSPECTION

Measure pump tip clearance.
SERVICE LIMIT: 0.10 mm (0.004 in)

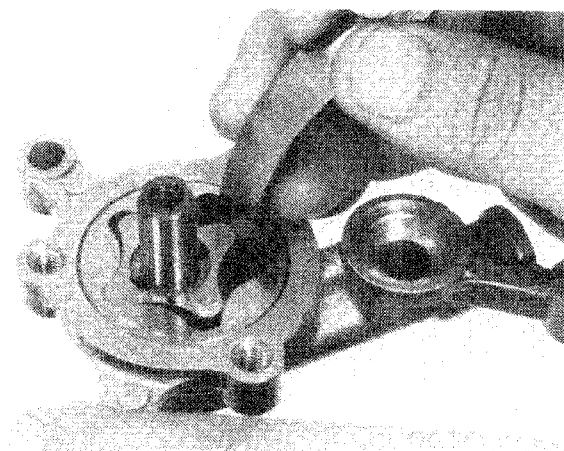



Measure the pump body clearance.
SERVICE LIMIT: 0.35 mm (0.014 in)

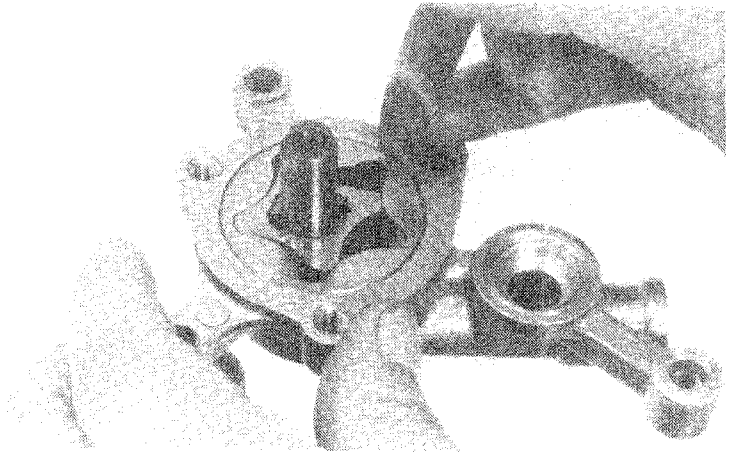

Measure the pump end clearance with a straight edge and feeler gauge.
SERVICE LIMIT: 0.10 mm (0.004 in)

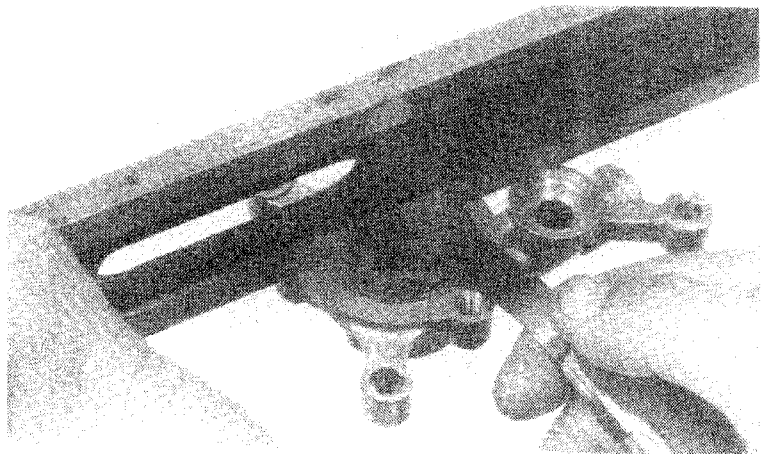

RELIEF VALVE INSPECTION

Remove the valve as an assembly and check its operation.

If the valve does not operate properly, disassemble it and check for a stuck valve or weak spring.

Replace the relief valve as a unit if the spring or plunger is damaged.

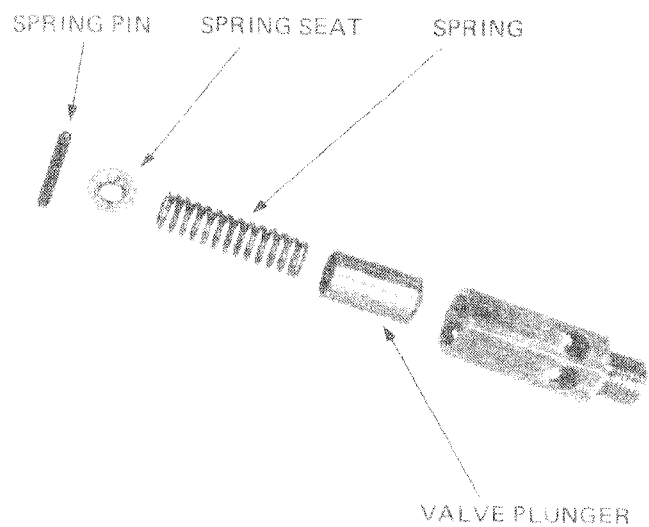



CLUTCH/OIL PUMP

OIL PUMP ASSEMBLY

Insert the outer and inner rotors into the pump body.
Slide the drive pin into the pump shaft, and install the shaft.
Install the thrust washer and drive pin.
Install the pump cover.

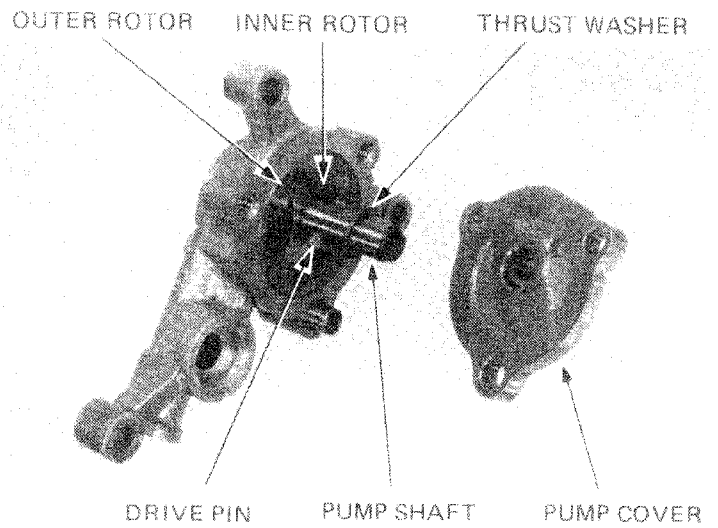

Install the oil strainer.
Install the oil pressure relief valve and pump sprocket. Do not tighten at this time.

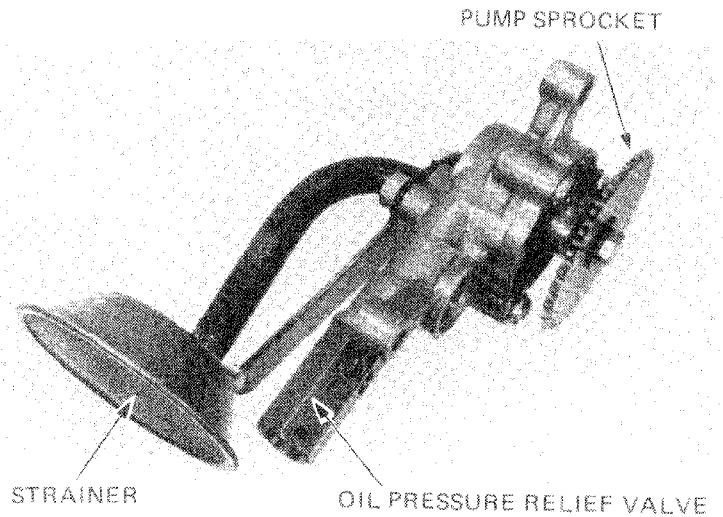

OIL PUMP INSTALLATION

Install the dowel pin.
Install the oil pump.
Do not tighten the mounting bolts at this time.
Place the drive chain over the pump and drive sprockets.

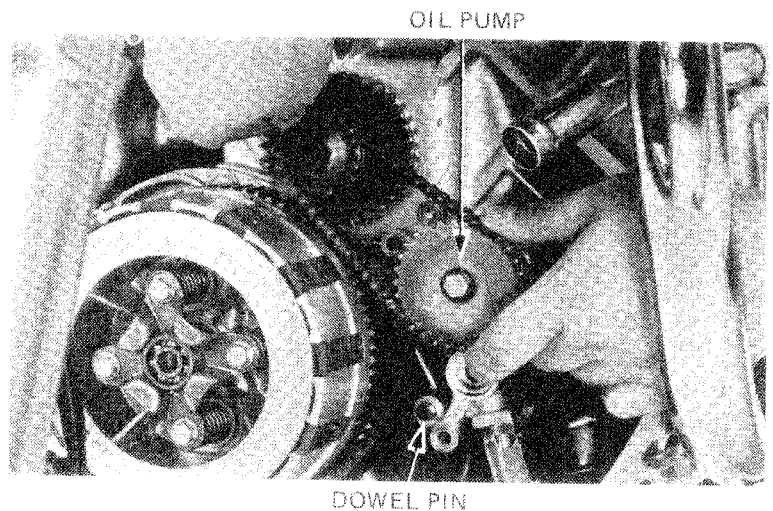



Tighten the pump sprocket bolt and relief valve.
Adjust the chain free play by rotating the pump
right or left, then torque the pump bolts.

FREE PLAY : 2.0–3.5 mm (0.80–0.14 in)

Tighten the three pump bolts.

TORQUE: 8–12 N·m (0.8–1.2 kg·m, 6–9 ft·lb)

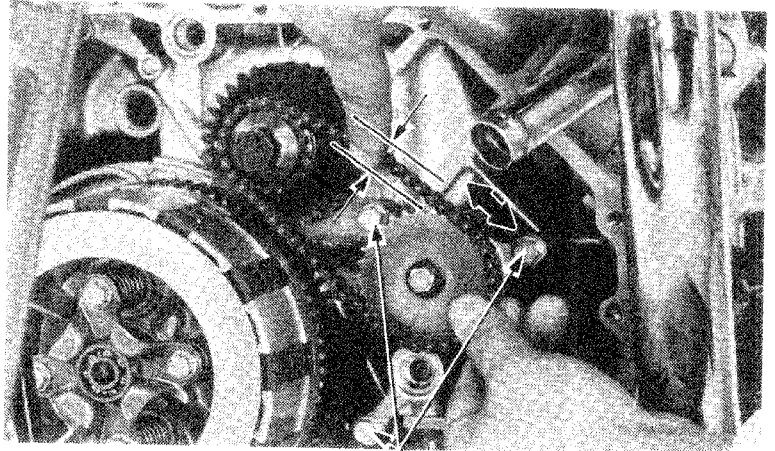

PUMP BOLTS

Recheck the oil pump drive chain free play.

FREE PLAY: 2.0–3.5 mm (0.08–0.14 in)

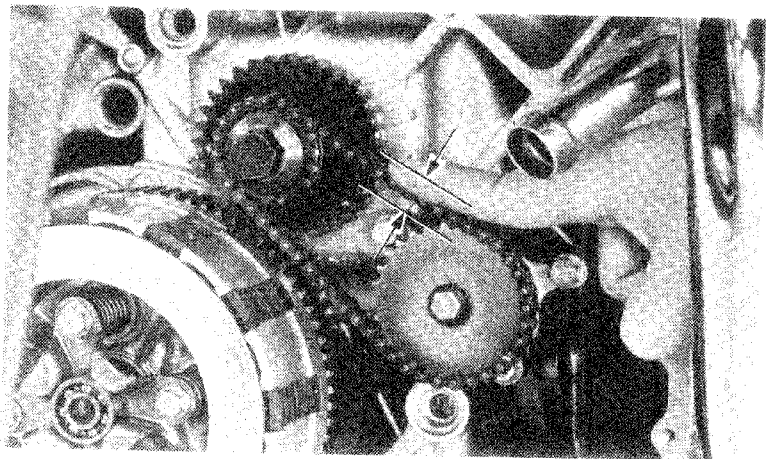

Install the dowel pins, collars, O rings and gasket.

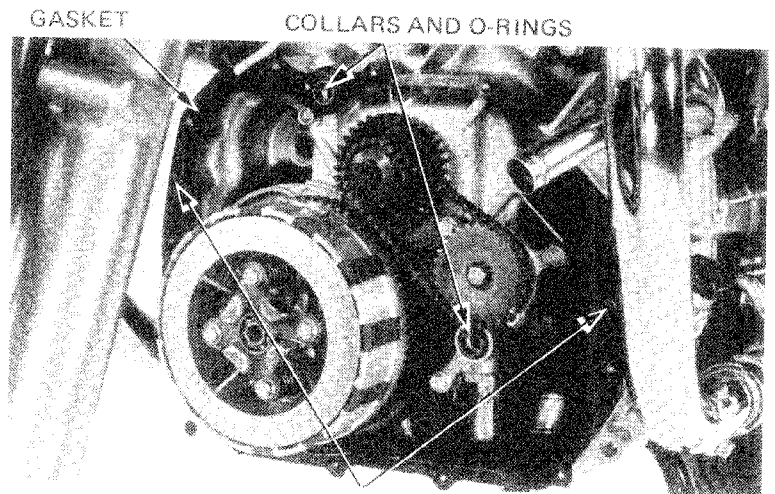

GASKET

COLLARS AND O-RINGS

DOWEL PINS



CLUTCH/OIL PUMP

Install the engine front cover.
Connect the oil pressure switch wire.

OIL PRESSURE SWITCH WIRE

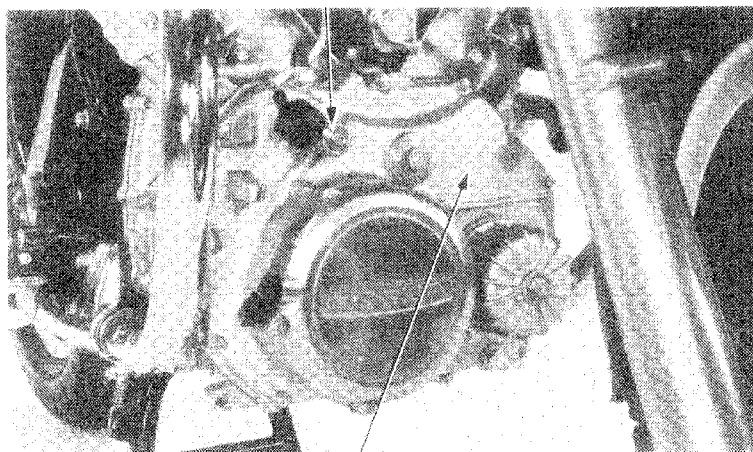

ENGINE FRONT COVER

Connect the clutch cable.
Adjust the clutch free play (Page 3-14).
Install the right engine hanger (Page 6-16).
Install the cooling fan cover and cooling fan (Page 9-9).
Install the radiator and fill to the proper level with coolant (Page 9-10).
Add the specified amount of engine oil (Section 2).

CLUTCH CABLE

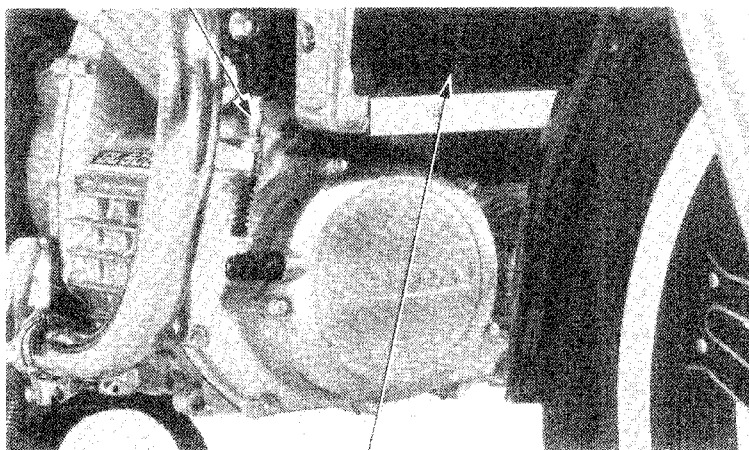

RADIATOR



HONDA
GL500
GL500 INTERSTATE

MEMO

AC GENERATOR/FLYWHEEL/
REAR COVER



HONDA
GL500
GL500 INTERSTATE

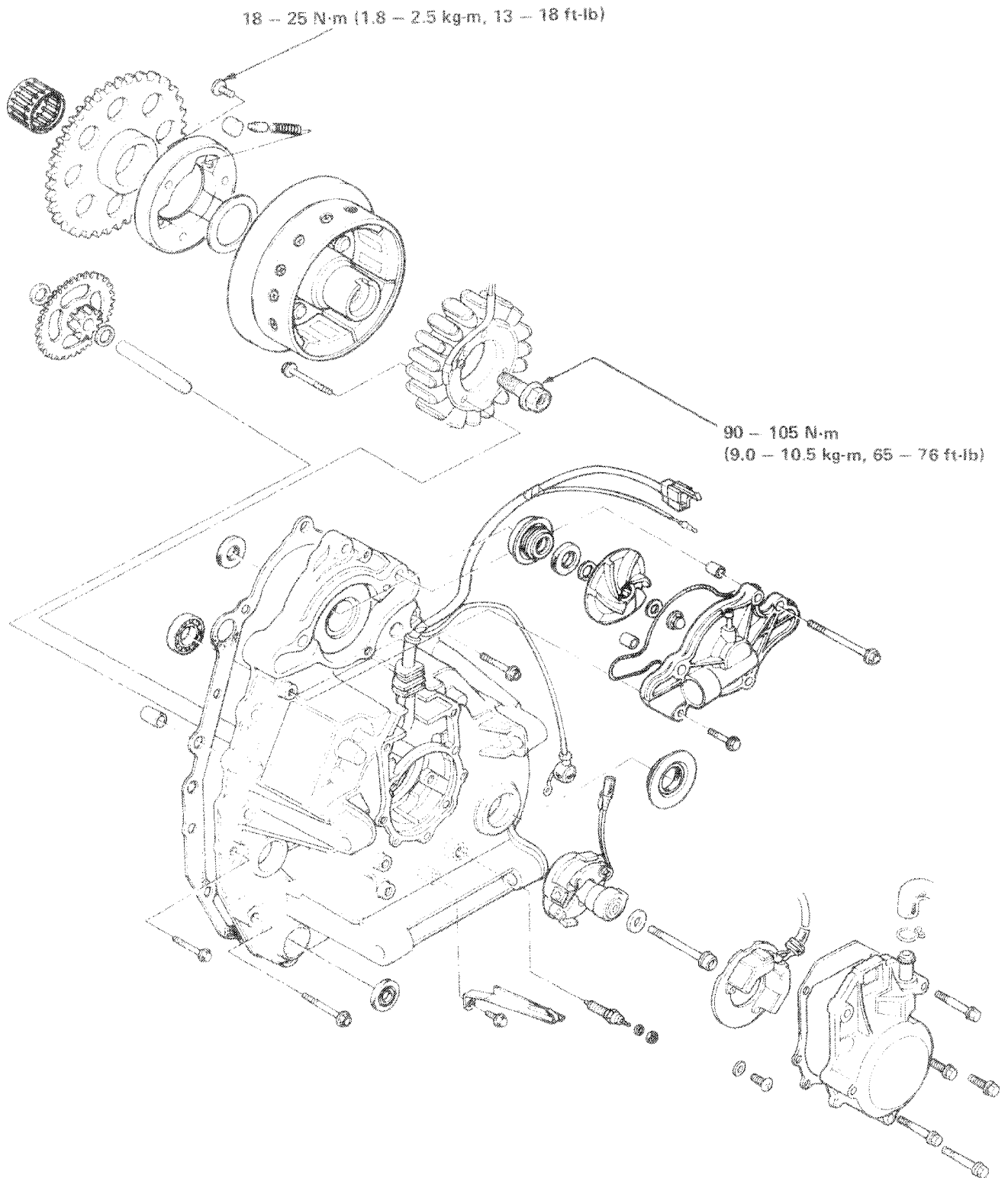



8. AC GENERATOR/FLYWHEEL/ REAR COVER

SERVICE INFORMATION	8-1	STARTER CLUTCH OUTER INSTALLATION	8-7
ENGINE REAR COVER REMOVAL	8-2	FLYWHEEL INSTALLATION	8-8
FLYWHEEL REMOVAL	8-4	ENGINE REAR COVER INSTALLATION	8-9
STARTER CLUTCH OUTER REMOVAL	8-6		

SERVICE INFORMATION

GENERAL INSTRUCTIONS

- To inspect and adjust the pulse generator, see Section 17 IGNITION SYSTEM.
- Be sure to adjust the ignition timing whenever the rear engine cover is removed.
- The pulse generator, starter motor and water pump impeller can be serviced with the engine installed in the frame.
- Take care not to cut the AC generator and stator wires and wire harnesses when removing or installing parts.
- For AC generator inspection, see Section 16 BATTERY CHARGING SYSTEM.

TOOLS

Special

- | | |
|-----------------------|-----------------------------------------------------------------|
| Gear holder | 07924-4150000 |
| Torx driver bit (T40) | 07703-0010100 Equivalent tools commercially available in U.S.A. |

Common

- | | |
|-----------------|-----------------------------------------------------------------|
| Extension | 07716-0020500 Equivalent tools commercially available in U.S.A. |
| Flywheel puller | 07733-0020001 or 07933-3950000 |
| Driver | 07749-0010000 |
| Attachment | 07945-3330300 |
| Pilot 22 mm | 07746-0041000 |

TORQUE VALUES

- | | |
|--------------------------|-----------------------------------------------|
| AC generator rotor bolt | 90 - 105 N-m (9.0 - 10.5 kg-m, 65 - 76 ft-lb) |
| Starter clutch torx bolt | 18 - 25 N-m (1.8 - 2.5 kg-m, 13 - 18 ft-lb) |



ENGINE REAR COVER REMOVAL

Drain engine oil.
Remove the engine from the frame (Section 5).

WATER PUMP REMOVAL

Remove the gearshift pedal.
Remove the water pipe holders.
Remove the water pipe.

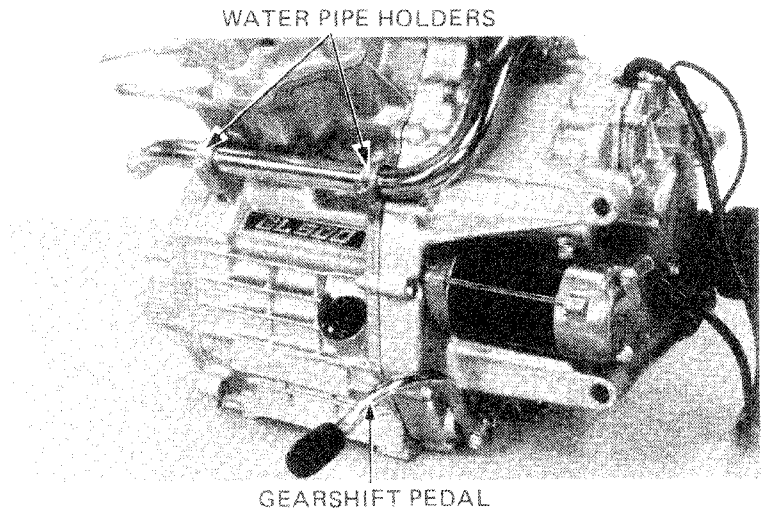

Remove the water pump cover.
Remove the dowel pins.
Remove the cap nut, copper washer and impeller.
Remove the impeller collar.

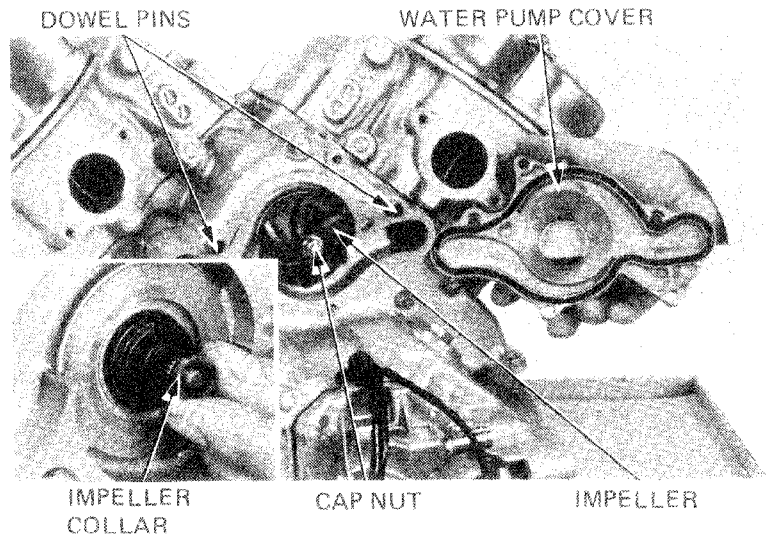

PULSE GENERATOR REMOVAL

Remove the pulse generator cover.

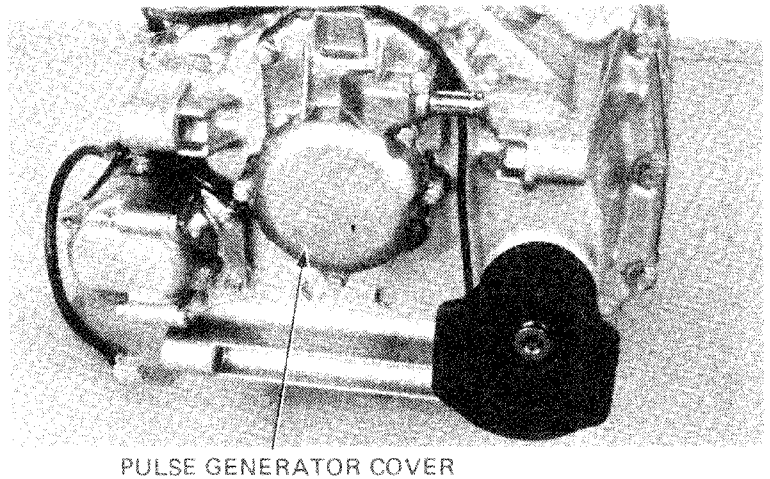



Remove the pulse generator by removing the two screws.

Remove the 6 mm bolt and spark advancer from the crankshaft.

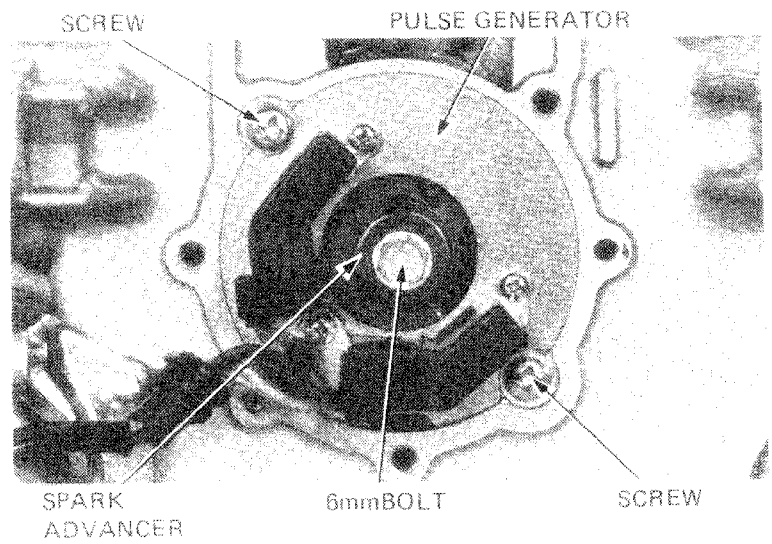

ENGINE REAR COVER REMOVAL/DIS-ASSEMBLY

Remove the starter motor.
Remove the rear cover.

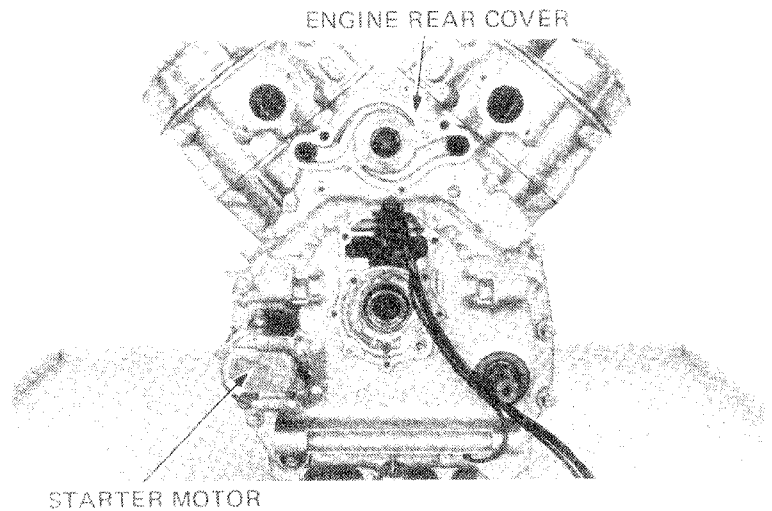

Remove the collars, O-rings, dowel pins, and gasket.
Remove the final shaft.

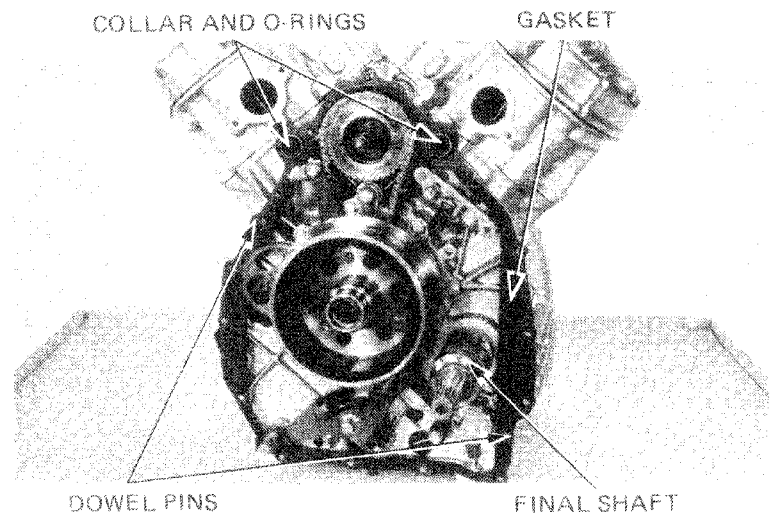

AC GENERATOR/FLYWHEEL/ REAR COVER



HONDA
GL500
GL500 INTERSTATE

Remove the water pump mechanical seal (Page 9-7).
Remove the final shaft and shift spindle oil seals.
Remove the neutral wire clamp and disconnect it
from the neutral switch.
Remove the neutral switch and sealing washer.

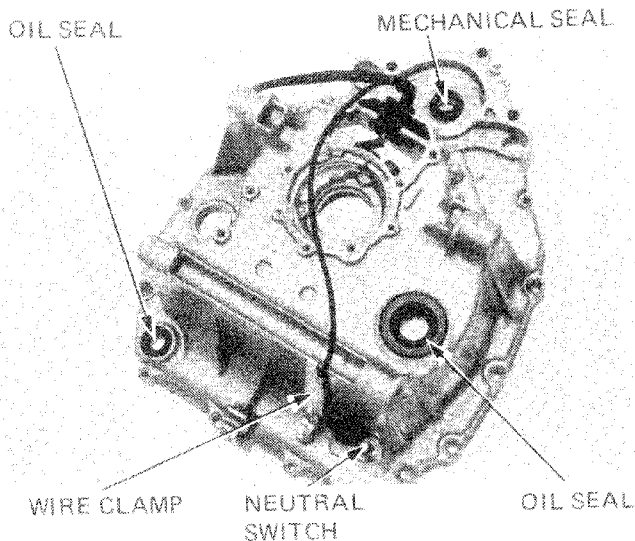

Remove the AC generator stator and the final shaft
bearing.

NOTE

- Do not damage the stator coil.
- Refer to page 19-2, for neutral switch inspection.

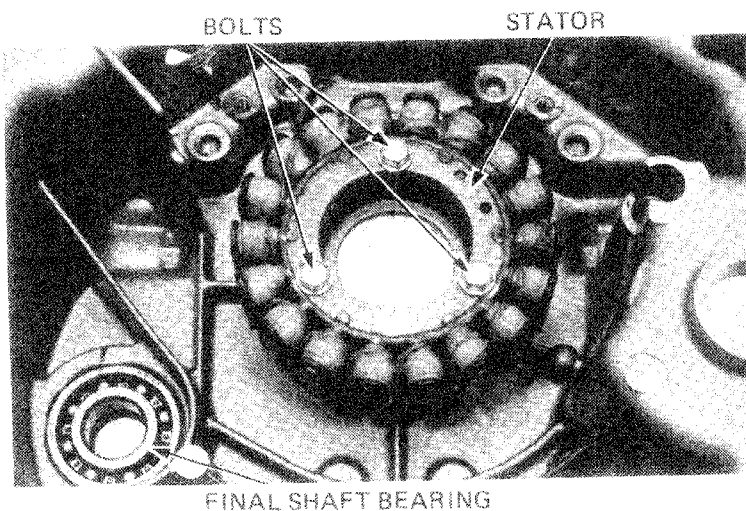

FLYWHEEL REMOVAL

Remove the front engine cover (Page 7-9).
Attach the GEAR HOLDER to the primary drive
gear.

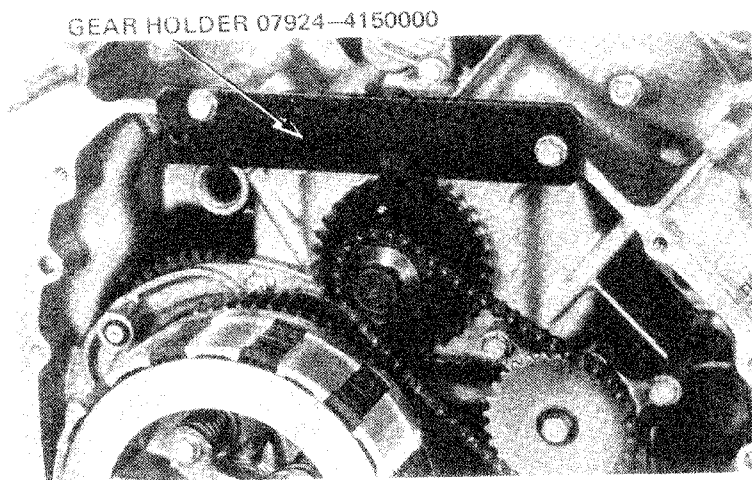



Remove the flywheel bolt.

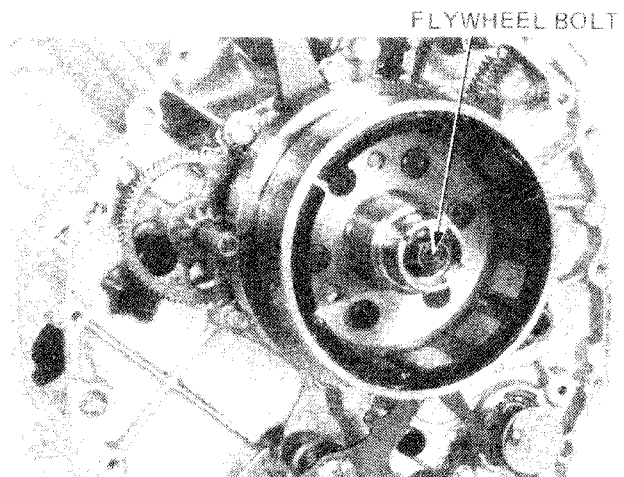

Remove the flywheel.

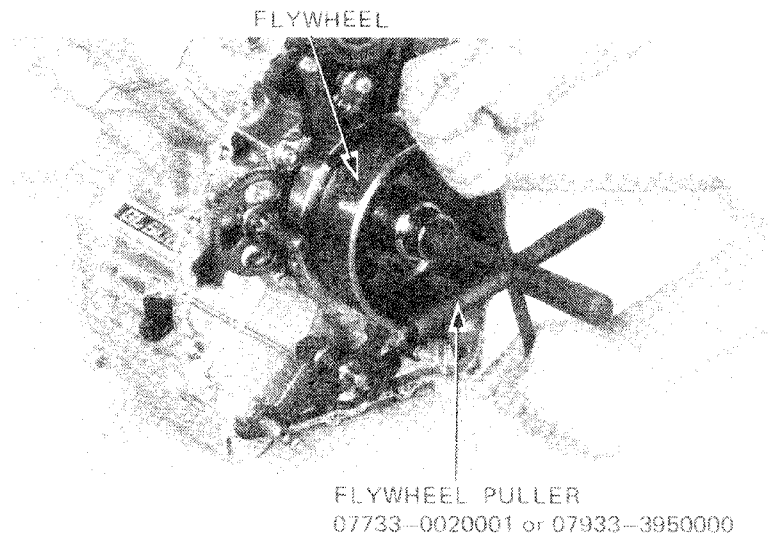

Remove the starter driven gear.
Remove the starter reduction shaft and gear.

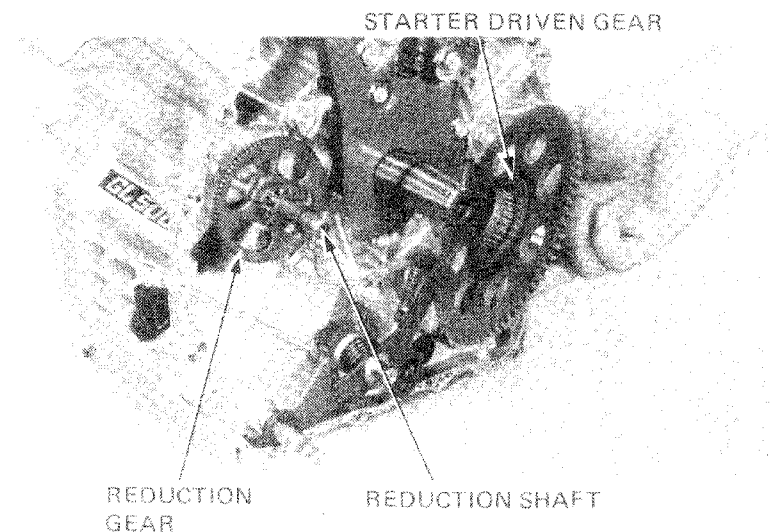



REDUCTION GEAR INSPECTION

Inspect the reduction gear teeth for damage.
Measure the reduction gear I.D.
Measure the reduction gear shaft O.D.
Calculate the gear to shaft clearance.

SERVICE LIMIT: 0.20 mm (0.008 in)

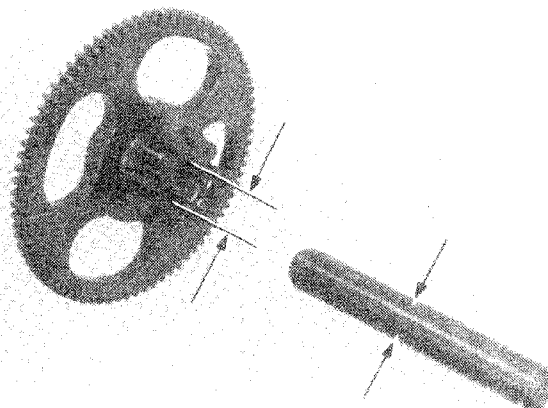

STARTER DRIVE GEAR INSPECTION

Check the drive gear for damage, excessive wear, indentations or other faults. Measure the gear I.D.

SERVICE LIMIT: 37.10 mm (1.461 in)

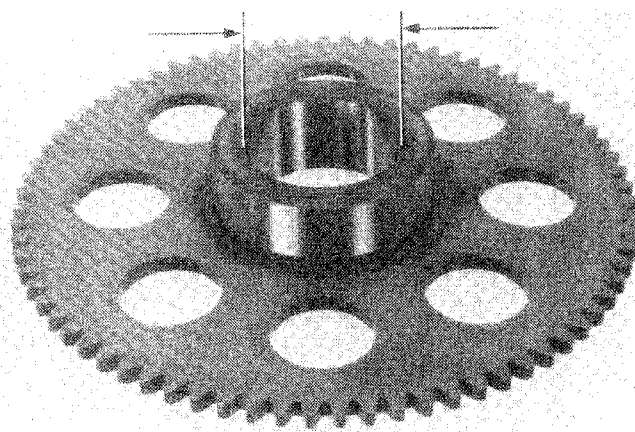

STARTER CLUTCH OUTER REMOVAL

Remove the starter clutch rollers, springs and plunger.

Remove the TORX bolts.

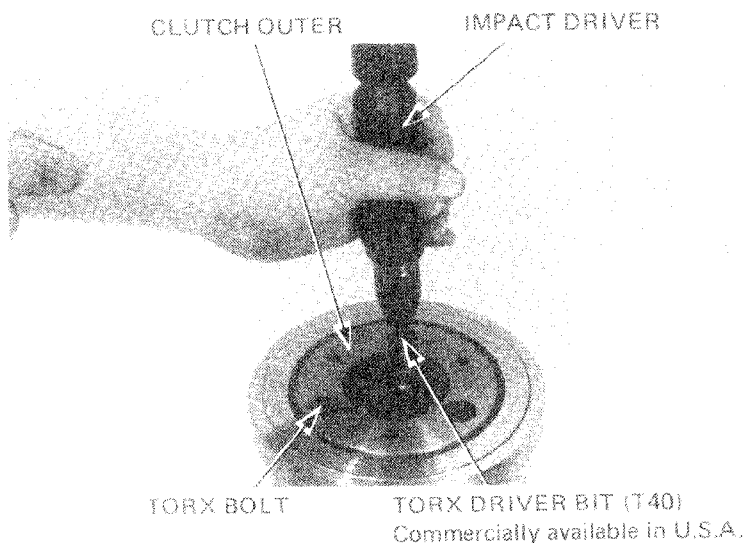



STARTER CLUTCH OUTER INSPECTION

Inspect the rollers for freedom of movement in their grooves.
Inspect each roller and replace if it is worn or damaged.
Inspect the clutch outer for damaged or worn roller surfaces.
Examine the springs and plungers for distortion or excessive wear.

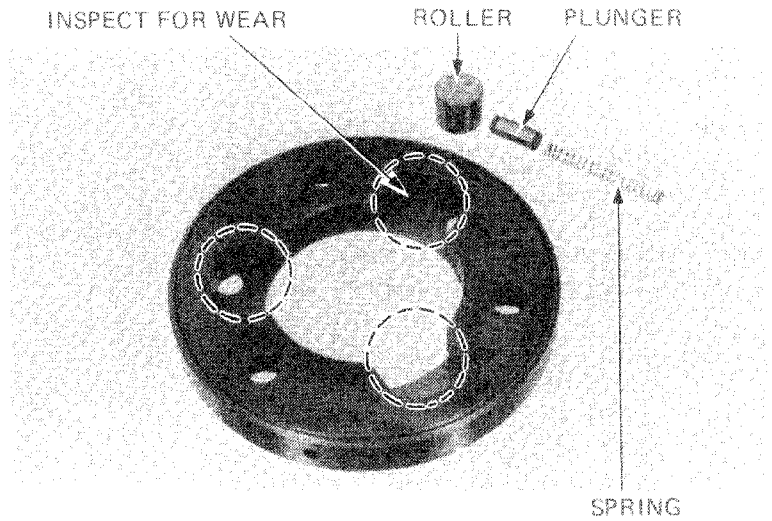

STARTER CLUTCH OUTER INSTALLATION

Slide the clutch outer into the flywheel, aligning the holes with the dowel pins in the flywheel. Install and torque the TORX bolts.

NOTE

Replace used TORX bolts.

TORQUE: 18 – 25 N·m (1.8 – 2.5 kg·m,
13 – 18 ft·lb)

NOTE

Coat the threads and undersides of the TORX bolts with a locking agent prior to installation.

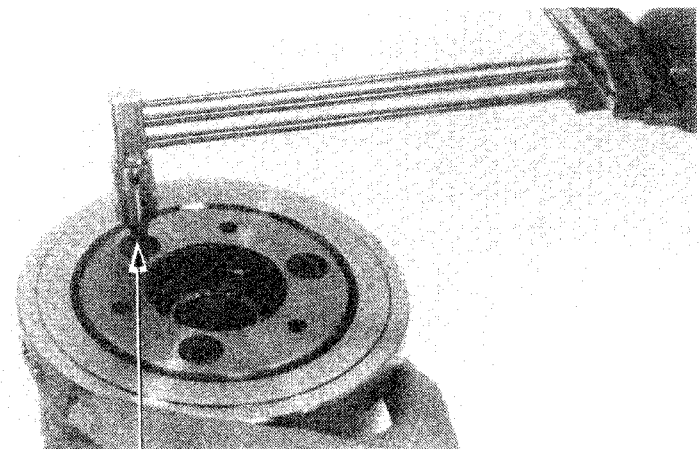

TORX DRIVER BIT (T40)
Commercially available in U.S.A.

Slide the spring into the plunger and install in the clutch outer.
Position the roller into place while holding the plunger with a screwdriver as shown.

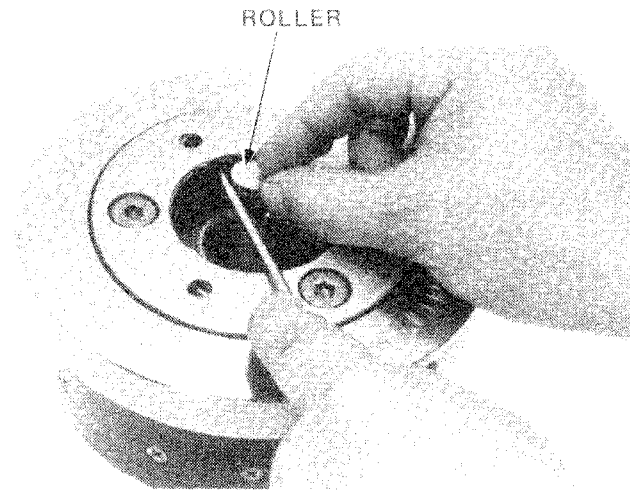

ROLLER



Install the reduction shaft, thrust washers and reduction gear.

NOTE

Use two thrust washers, one on each side of the reduction gear.

Install the needle roller bearing in the drive gear. Install the drive gear onto the crankshaft.

THRUST WASHER

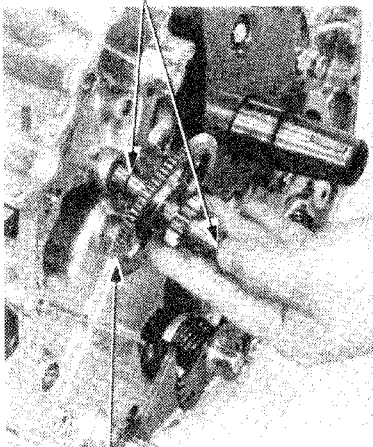

REDUCTION GEAR

NEEDLE ROLLER BEARING

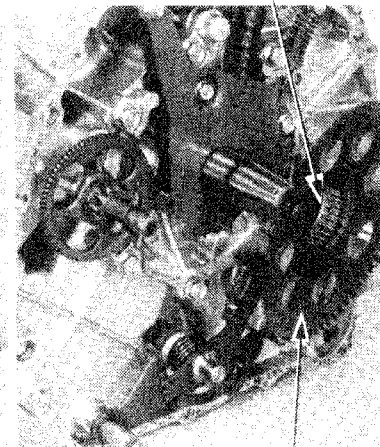

DRIVE GEAR

FLYWHEEL INSTALLATION

Install the flywheel onto the crankshaft.

NOTE

- Align the key in the crankshaft with the keyway in the flywheel.
- Rotate the flywheel counterclockwise to aid installation.

FLYWHEEL

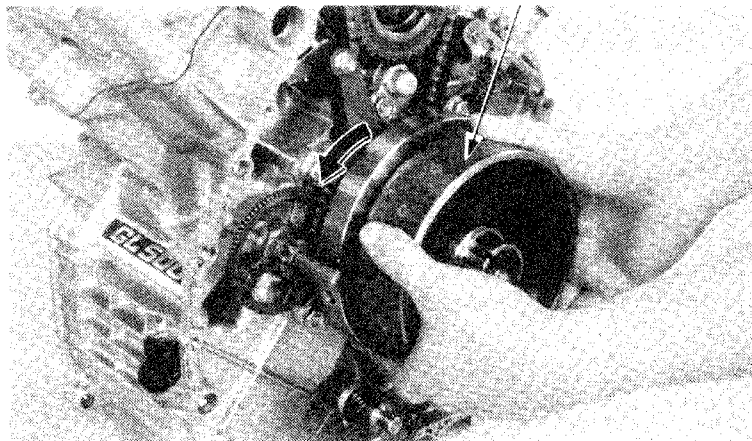

Install and tighten the flywheel bolt.

TORQUE: 90–105 N·m (9.0–10.5 kg·m,
65–76 ft·lb)

Remove the GEAR HOLDER from the primary drive gear.

Install the front engine cover.

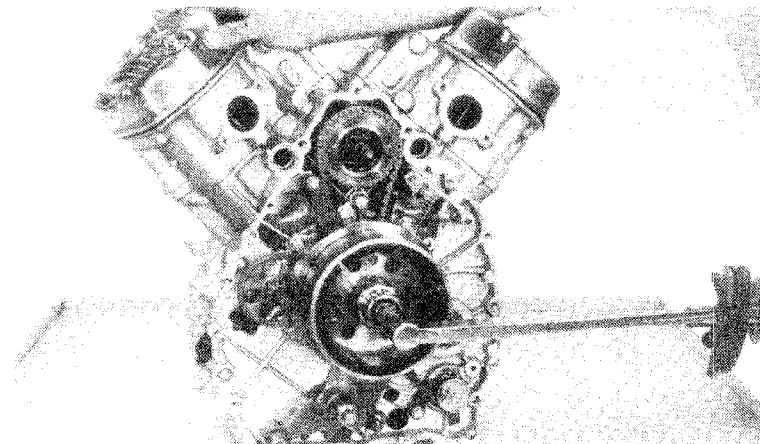



ENGINE REAR COVER INSTALLATION

REAR COVER ASSEMBLY

The assembly sequence is essentially the reverse of disassembly.

NOTE

- Install the final shaft bearing until it seats.
- Refer to page 9-7 for water pump mechanical seal installation.

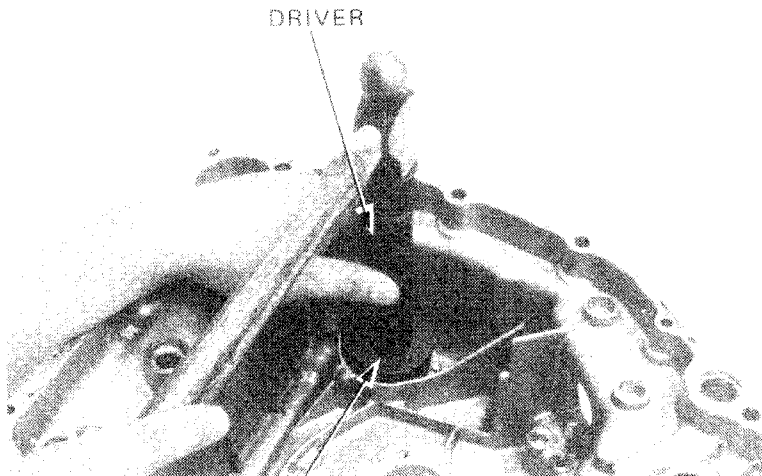

ATTACHMENT 07945-3330300
AND PILOT 22 mm

Install the final shaft.
Install the dowel pins, O-rings, collars and gasket.

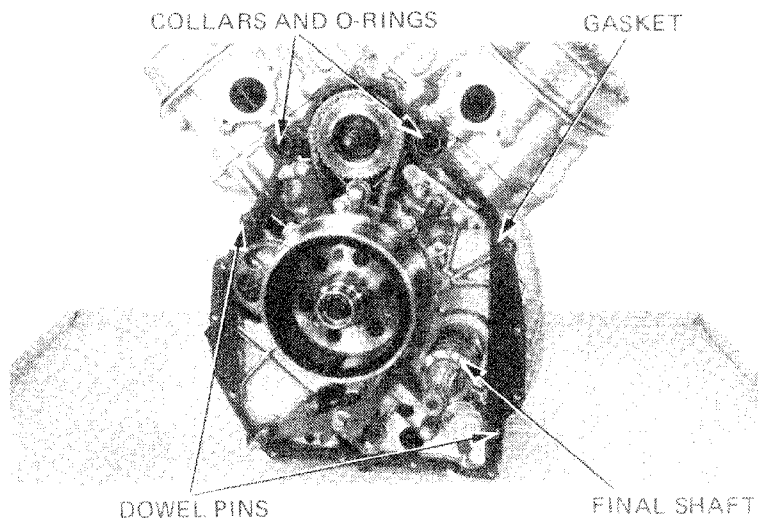

Install the engine rear cover and tighten the bolts.

TORQUE:

- 6 mm bolts:
8–12 N·m (0.8–1.2 kg·m, 6–9 ft·lb)
- 8 mm bolts:
18–25 N·m (1.8–2.5 kg·m, 13–18 ft·lb)

Install the starter motor.

NOTE

- Engage the starter drive gear with the reduction gear before tightening the cover.
- Tighten the rear cover bolts in a crisscross pattern in 2-3 steps.

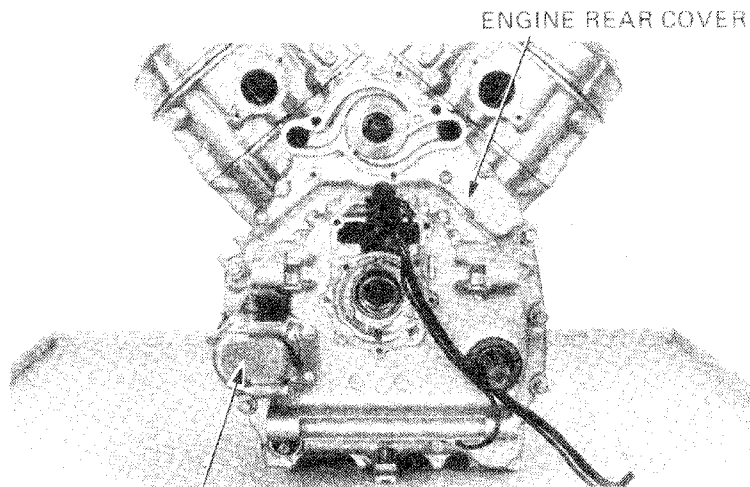

REAR COVER INSTALLATION

Install the spark advancer.

NOTE

Align the lug of the advancer with the cut-out in the crankshaft.

Tighten the 6 mm bolt.

TORQUE: 8–12 N·m (0.8–1.2 kg·m, 6–9 ft·lb)

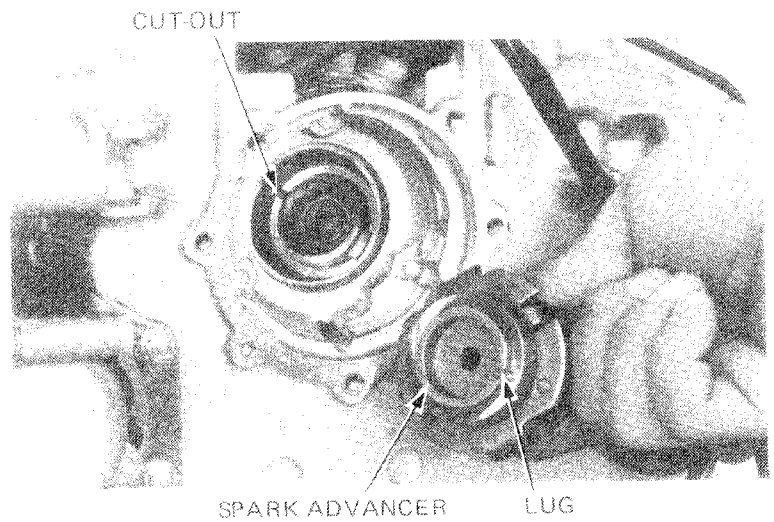

IGNITION TIMING ADJUSTMENT

Remove the timing inspection hole cap.

Rotate the crankshaft, and align the "FS" mark on the right side with the index mark on the rear engine cover.

Install the pulse generator assembly, aligning the right pulse generator steel core with the rotor tooth.

Tighten the screws securely.

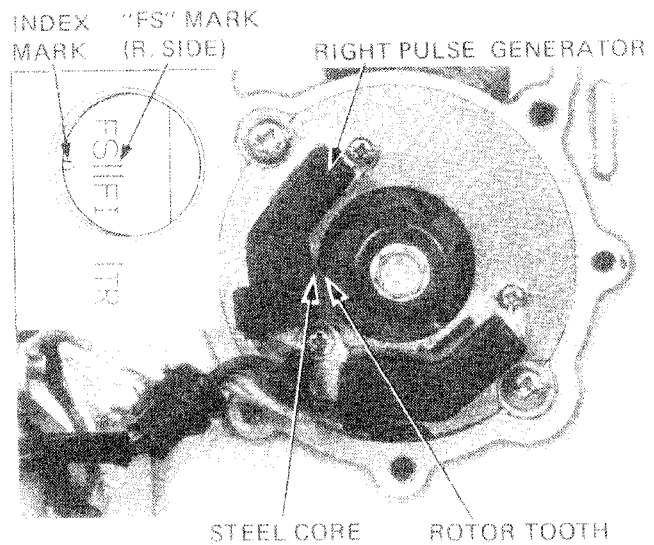

Rotate the crankshaft clockwise, and align the "FS" mark on the left side with the index mark on the rear engine cover. Check that the rotor tooth is aligned with the left pulse generator steel core.

Check the air gap between the rotor tooth and steel core and adjust if necessary (Page 17-6).

Adjust if necessary, move the pulse generator to right or left by loosening the generator attaching screws. Tighten the attaching screws.

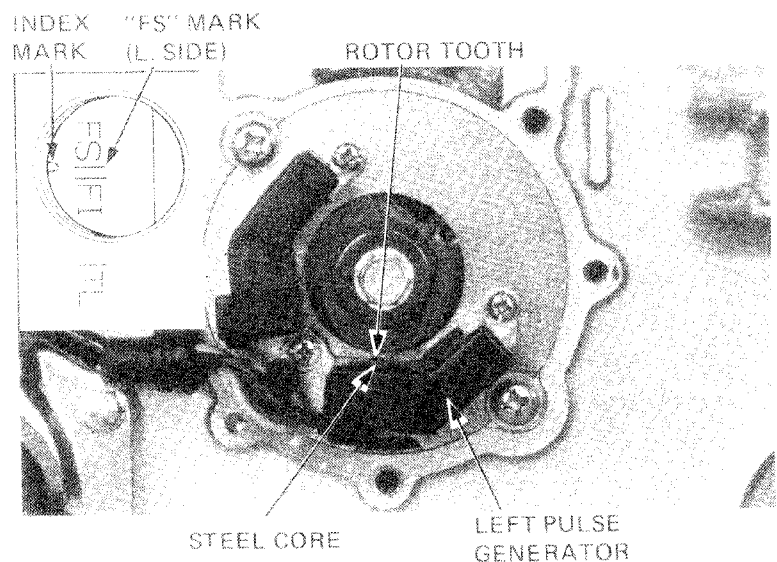



Apply adhesive to the surface indicated by the arrow and install the gasket over the surface.

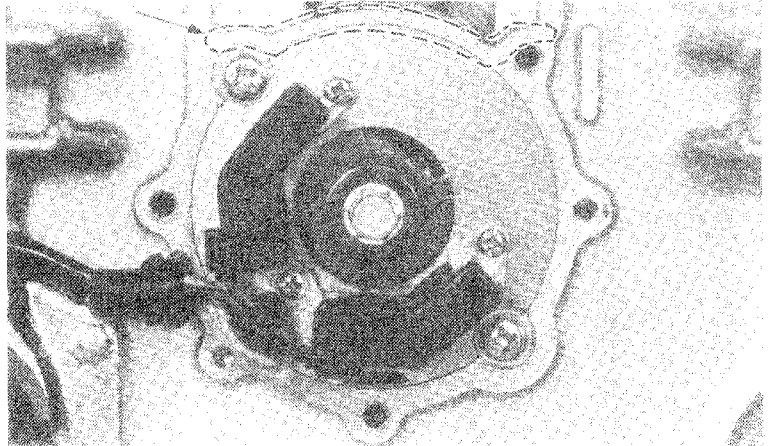

Install the pulse generator cover.

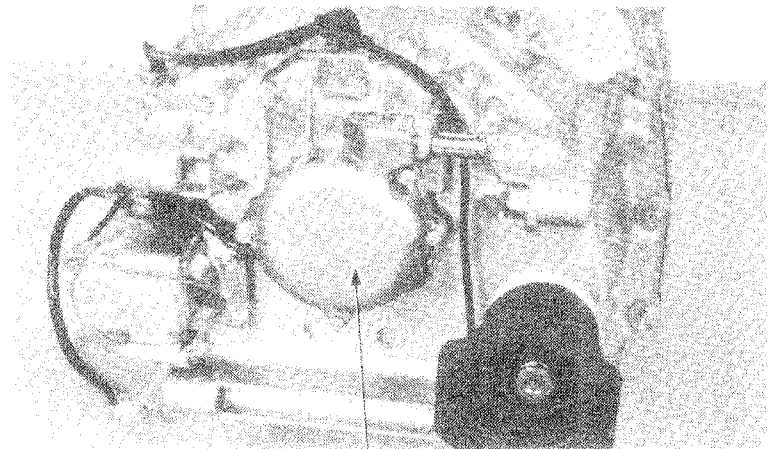

PULSE GENERATOR COVER

WATER PUMP INSTALLATION

Install the impeller collar on the camshaft.

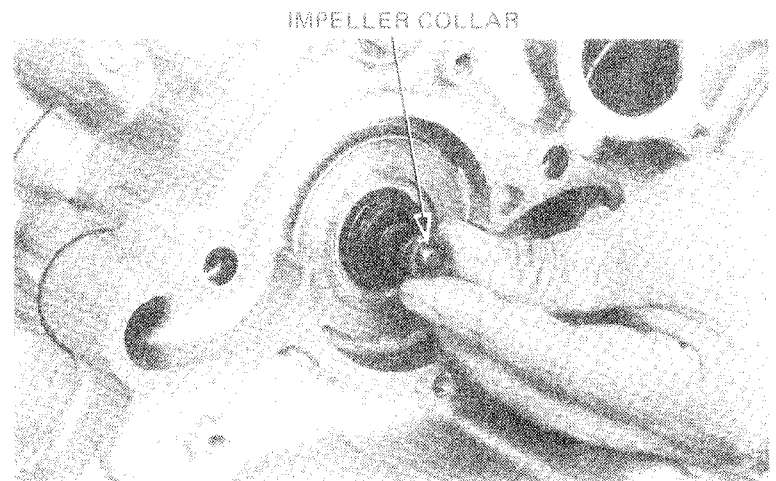

AC GENERATOR/FLYWHEEL/
REAR COVER

Install the rubber seal and seal washer in the impeller and apply soapy water to the sliding surfaces.

NOTE

- Dip the rubber seal in soapy water to facilitate installation.
- Check that the seal rubber is positioned properly.

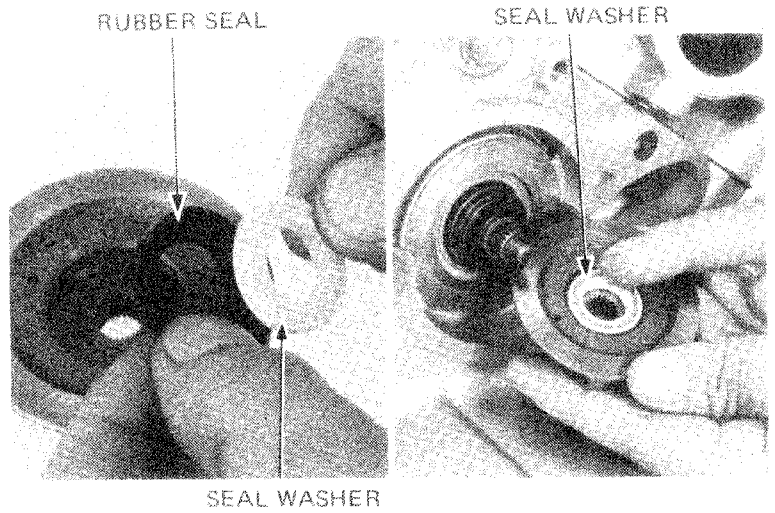

Install the impeller, copper washer and cap nut on the camshaft.

Tighten the cap nut.

TORQUE: 8–12 N·m (0.8–1.2 kg·m, 6–9 ft·lb)

Rotate the crankshaft to make sure that the pump turns freely without binding.

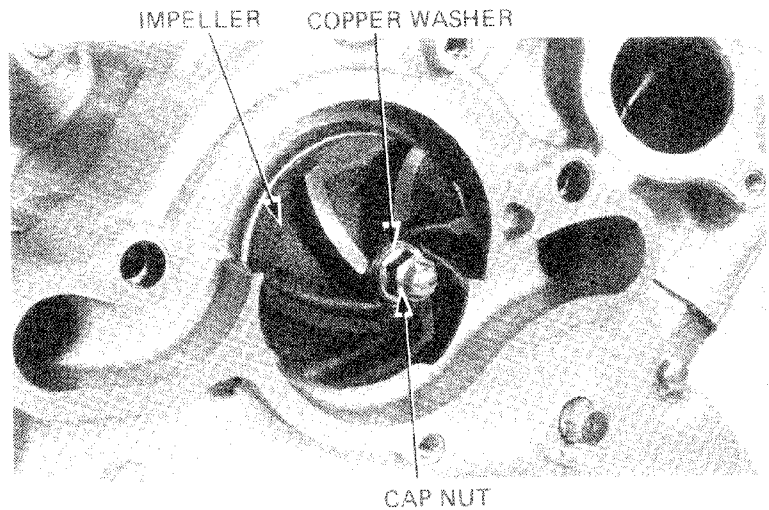

Check the pump cover rubber packing for deterioration or damage and replace if necessary.

Install the dowel pins in the case and install the cover.

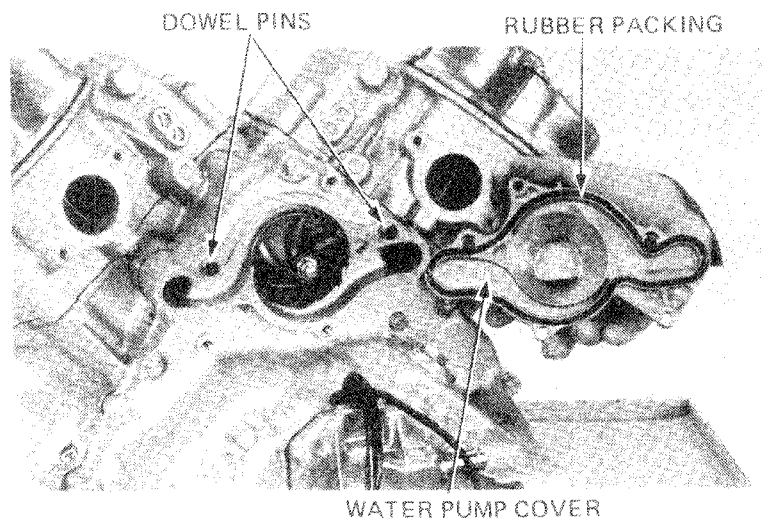



Tighten the pump cover bolts.

TORQUE:

6 mm bolts:

8–12 N·m (0.8–1.2 kg·m, 6–9 ft·lb)

8 mm bolts:

18–25 N·m (1.8–2.5 kg·m, 13–18 ft·lb)

Apply a soapy water to the water pipe O-ring and insert the water pipe in the pump cover.

NOTE

Make sure that the O-ring is not twisted.

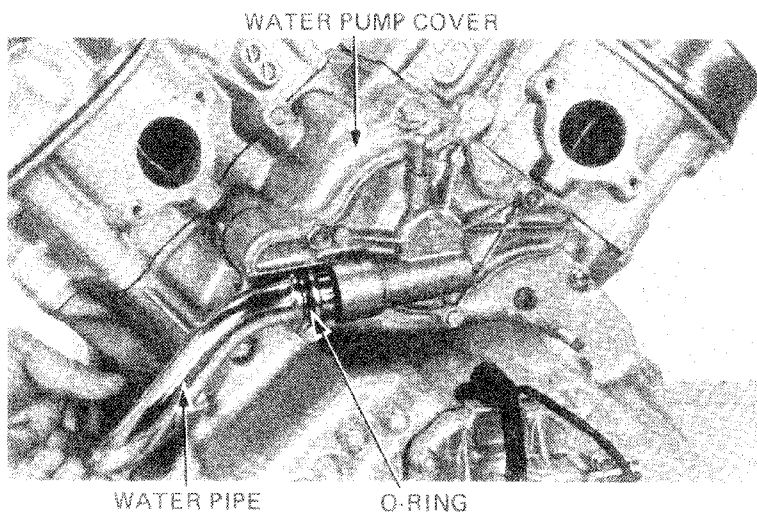

Install the water pipe holders.

NOTE

Tighten the upper bolts first, then tighten the lower bolts.

Install the gearshift pedal.

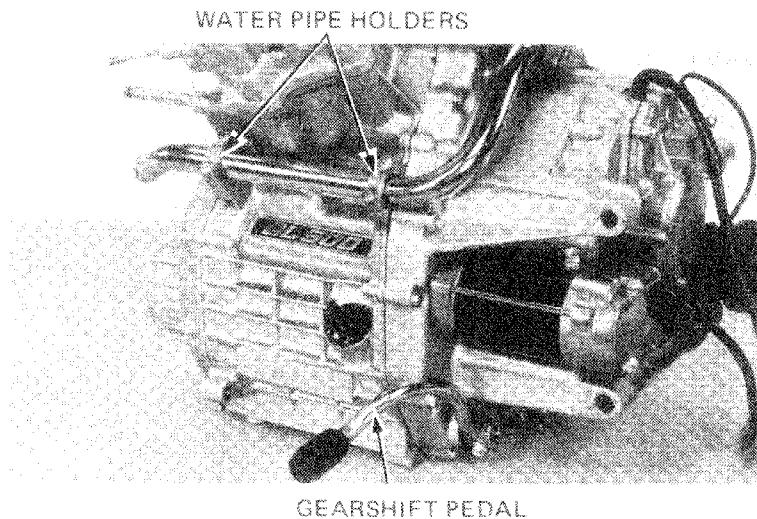



COOLING SYSTEM

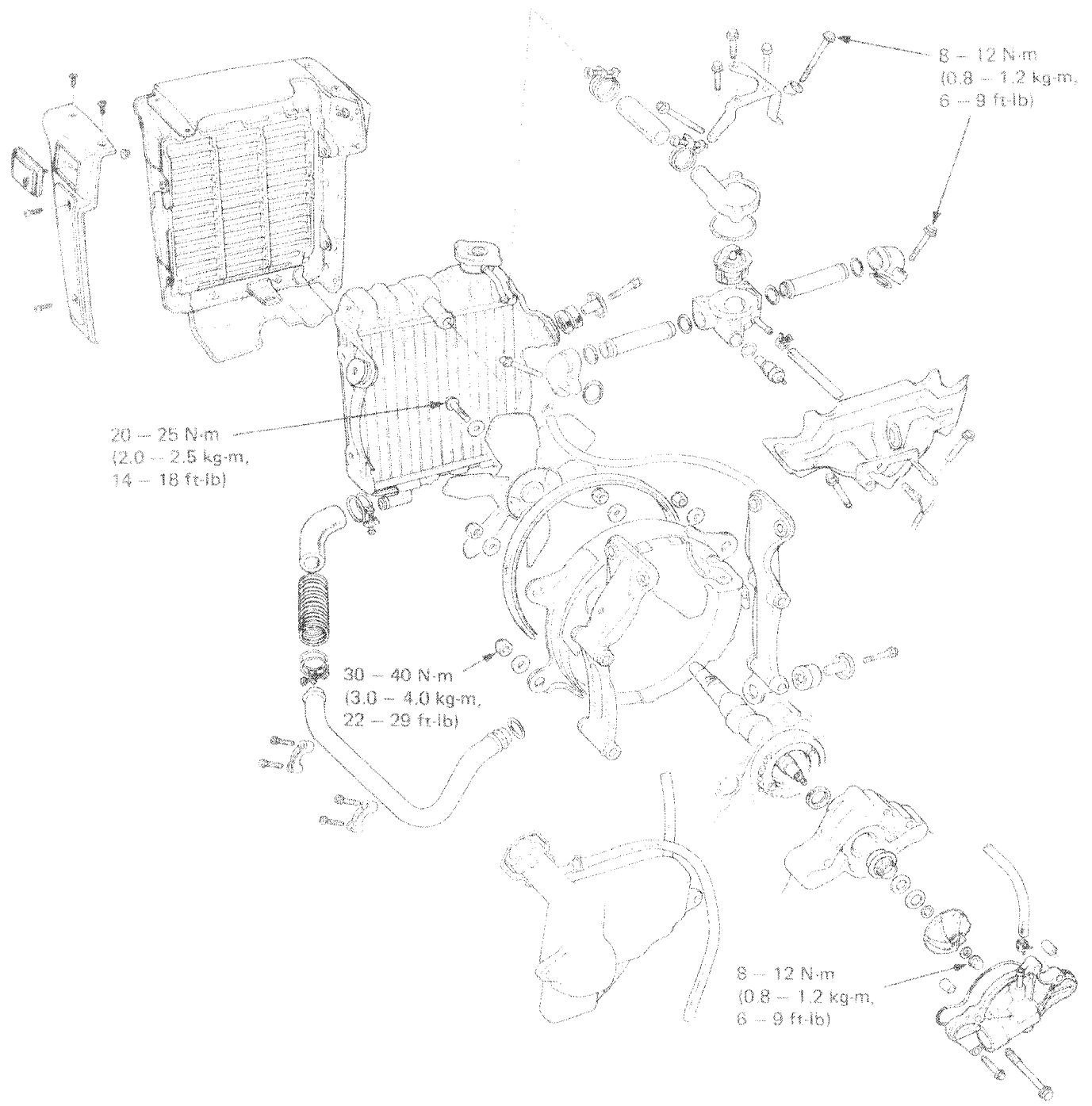



9. COOLING SYSTEM

SERVICE INFORMATION	9-1	COOLING FAN REMOVAL	9-6
TROUBLESHOOTING	9-1	WATER PUMP MECHANICAL	
SYSTEM TESTING	9-2	SEAL REPLACEMENT	9-7
COOLANT REPLACEMENT	9-3	THERMOSTAT INSTALLATION	9-8
THERMOSTAT REMOVAL	9-3	COOLING FAN INSTALLATION	9-9
RADIATOR REMOVAL	9-5	RADIATOR INSTALLATION	9-9

SERVICE INFORMATION

GENERAL INSTRUCTIONS

- To service the water pump seal, it is necessary to remove the rear engine cover. All the other cooling system services can be made with the engine in the frame.
- Do not remove the radiator cap when the engine is hot. The coolant is under pressure and severe scalding could result. The engine must be cool before servicing the cooling system.
- Avoid spilling coolant on painted surfaces. After servicing the system, check for leaks with a radiator tester.
- Refer to the section 8 for water pump service.

TOOLS

Special

Mechanical seal driver attachment 07945-4150400 or 07945-3710200

Common

Rotor puller 07733-0010000 or 07933-2000000
Driver 07749-0010000 or 07949-6110000

SPECIFICATIONS

Radiator cap relief pressure	0.75 – 1.05 kg/cm ² (10.7 – 14.9 psi)
Freezing point (Hydrometer test):	55% Distilled water + 45% ethylene glycol: -32°C (-25°F) 50% Distilled water + 50% ethylene glycol: -37°C (-34°F) 45% Distilled water + 55% ethylene glycol: -44.5°C (-48°F)
Coolant capacity:	
Radiator and engine	1.8 liters (1.9 U.S. qt.)
Reserve tank	0.2 liters (0.21 qt.)
Total system	2.0 liters (2.16 qt.)
Thermostat	Begins to open: 80° to 84°C (176° to 183°F) Fully open: 93° to 97°C (199° to 205°F) Valve lift: Minimum of 8 mm at 95°C (0.315 in. at 203°F)
Boiling point (with 50-50 mixture):	Unpressurized: 107.7°C (226°) Cap on, pressurized: 125.6°C (258°F)

TORQUE VALUES

Cooling fan bolt 20 – 25 N·m (2.0 – 2.5 kg-m, 14 – 18 ft-lb)
Engine hanger nut 30 – 40 N·m (3.0 – 4.0 kg-m, 22 – 29 ft-lb)

TROUBLESHOOTING

Engine Temperature Too High

- Faulty temperature gauge or gauge sensor
- Thermostat stuck closed
- Faulty radiator cap
- Insufficient coolant
- Passages blocked in radiator, hoses, or water jacket
- Fan blades bent

Engine Temperature Too Low

- Faulty temperature gauge or gauge sensor
- Thermostat stuck open

Coolant Leaks

- Faulty pump oil seal
- Deteriorated O-rings
- Radiator hose damage



COOLING SYSTEM

SYSTEM TESTING

COOLANT

Test the coolant mixture with an antifreeze tester. For minimum corrosion protection, a 50–50% solution of ethylene glycol and distilled water is recommended.

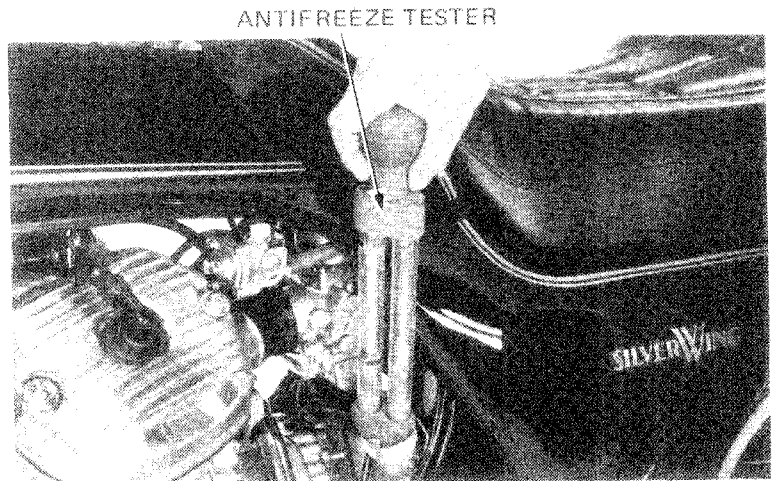

RADIATOR CAP INSPECTION

Pressure test the radiator cap. Replace the radiator cap if it does not hold pressure, or if relief pressure is too high or too low. It must hold specified pressure for at least six seconds.

NOTE

Before installing the cap on the tester, moisten to the sealing surfaces.

RADIATOR CAP RELIEF PRESSURE:

$90 \pm 15 \text{ kPa}$ ($0.9 \pm 0.15 \text{ kg/cm}^2$, $12.8 \pm 2.1 \text{ psi}$)

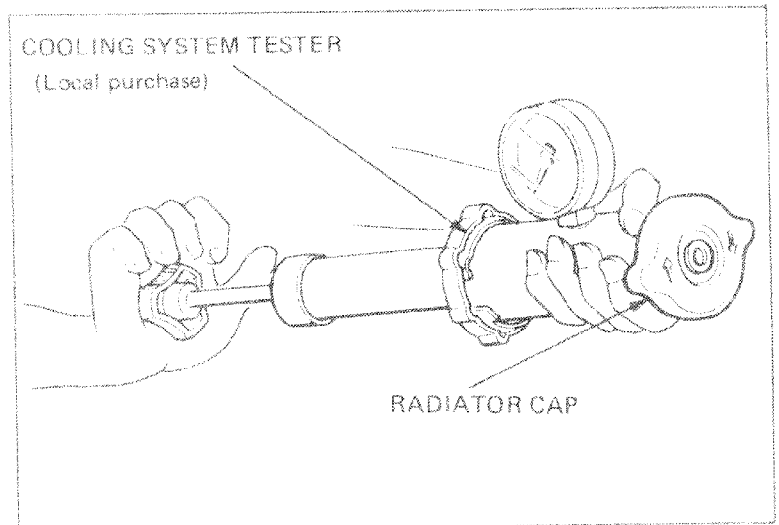

Pressurize the radiator, engine and hoses, and check for leaks.

CAUTION

Excessive pressure can damage the radiator. Do not exceed 105 kPa (1.05 kg/cm^2 , 14.9 psi).

Repair or replace components if the system will not hold specified pressure for at least six seconds.

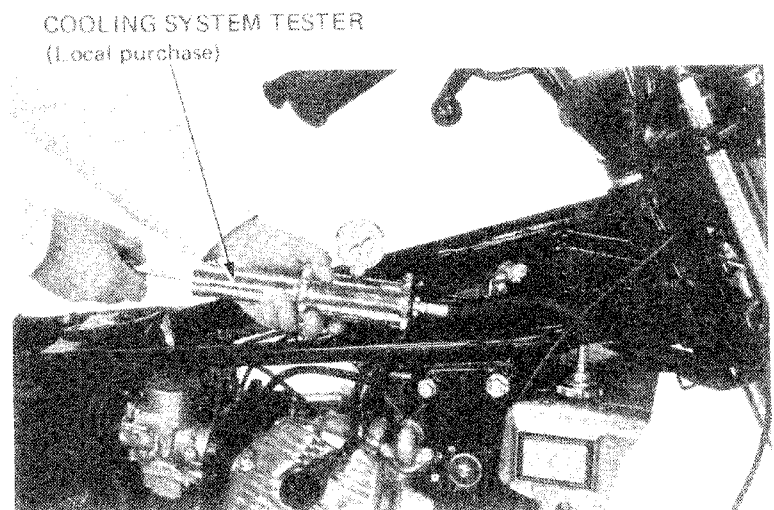



COOLANT REPLACEMENT

WARNING

The engine must be cool before servicing the cooling system, or severe scalding may result.

Remove the seat and fuel tank.
Remove the radiator cap.
Remove the radiator cover by removing the side screws.

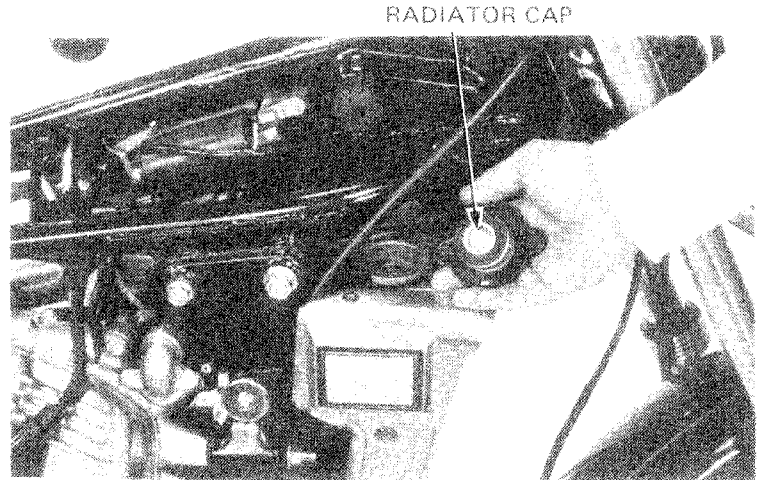

Remove the radiator drain plug, and drain the coolant (about 1.4 liters).
To drain coolant from the cylinders, remove the cylinder drain plugs (about 0.4 liters).
Replace the cylinder and radiator drain bolts.

CAUTION

Do not overtighten the radiator drain plug.

Fill the system with a 50-50 mixture of distilled water and ethylene glycol.

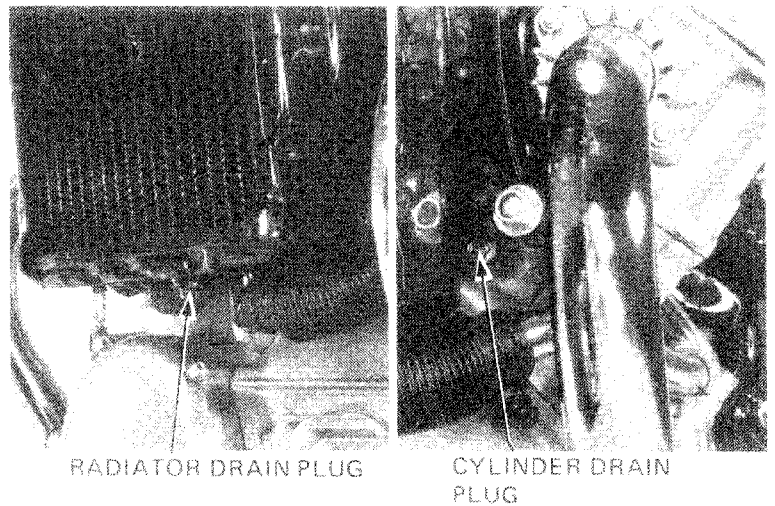

THERMOSTAT REMOVAL

Remove the seat and fuel tank.
Remove the coolant drain plug, and drain the coolant.
Disconnect the by-pass hose.
Disconnect the temperature and oil pressure switch wires.

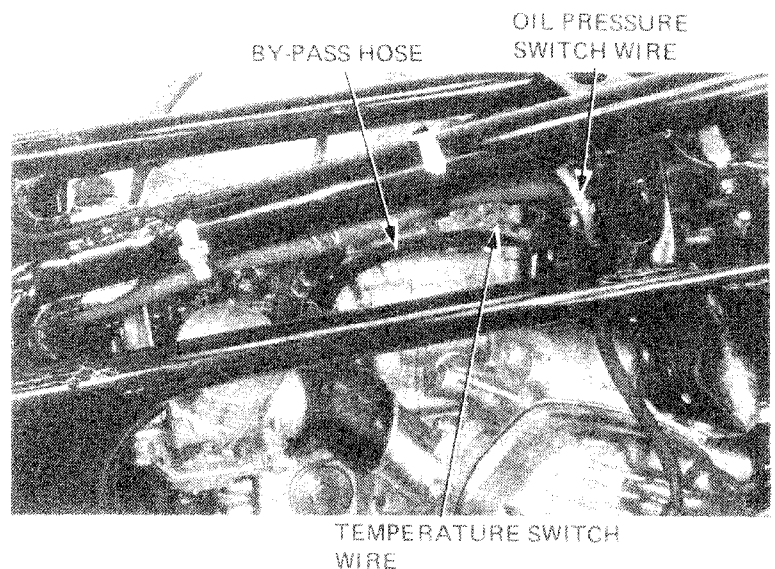



COOLING SYSTEM

Remove the air spoiler.
Remove the water pipe joints and water pipes.
Remove the thermostat bracket bolts.
Loosen the radiator hose band and pull the thermostat off the hose.

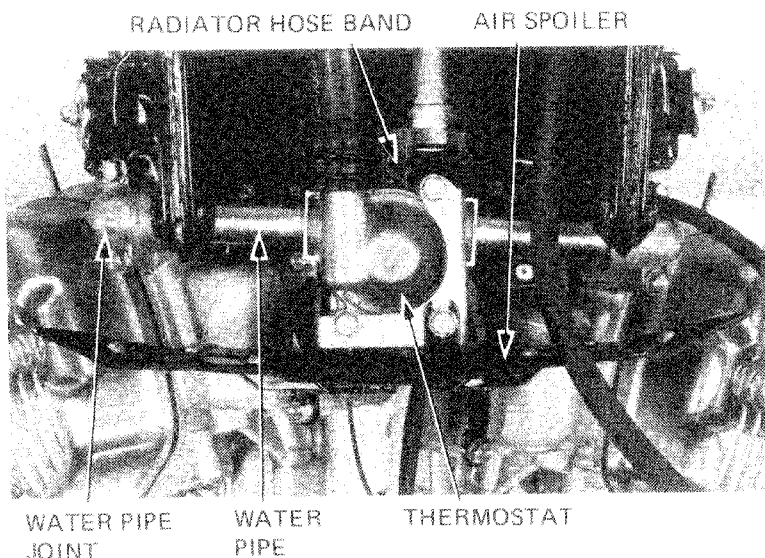

Separate the thermostat bracket from the thermostat housing.
Remove the thermostat cover and take out the thermostat.
Remove the water temperature unit.

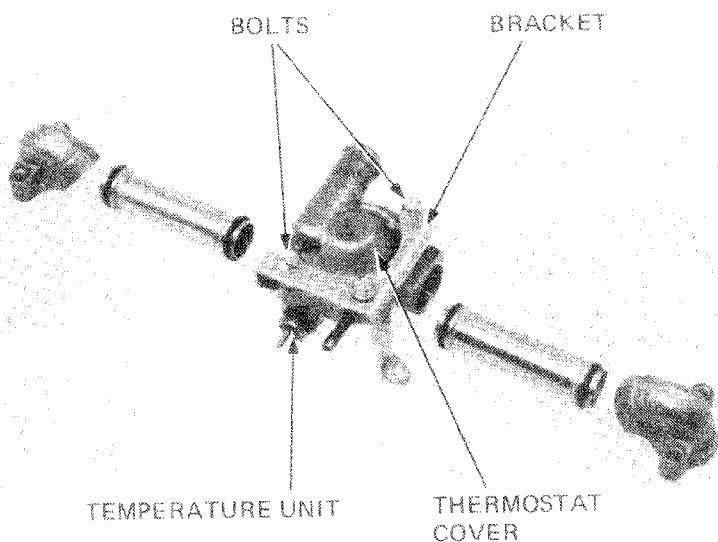

TEMPERATURE UNIT INSPECTION

Suspend the unit in oil and measure the resistance through the unit as the oil heats.

Temperature	60°C	85°C	110°C	120°C
	140°F	185°F	230°F	248°F
Resistance	104.0Ω	43.9Ω	20.3Ω	16.1Ω

Do not let the unit or thermometer touch the pan or false readings will result.

WARNING

Wear gloves and eye protection.

NOTE

Oil must be used as the heated liquid to check operation above 100°C (212°F).

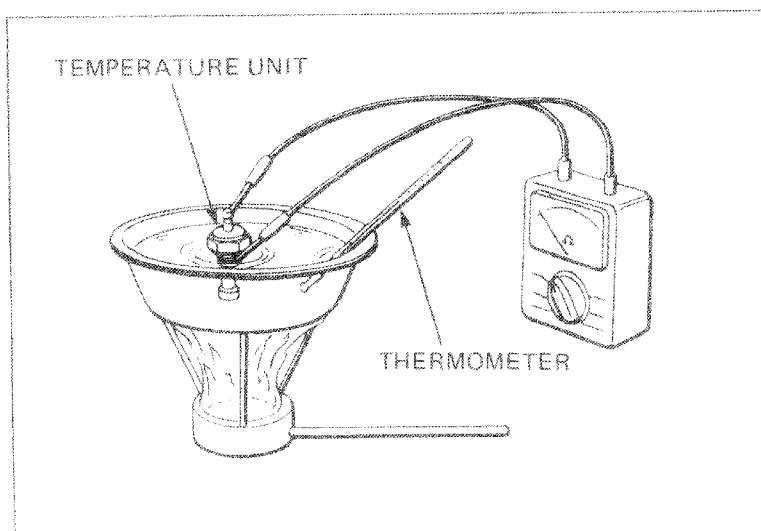



THERMOSTAT INSPECTION

Inspect the thermostat visually for damage.
Suspend the thermostat in hot water to check operation.

Do not let the thermostat or thermometer touch the pan or false readings will result.

Technical Data

Start to open	80° to 84°C (176° – 183°F)
Fully open	95°C (203°F)
Valve lift	8 mm (0.31 in) minimum

NOTE

- Replace thermostat if valve stays open at room temperature, or if it responds at temperatures other than those specified.
- Valve lift must be checked by applying heat for five minutes.

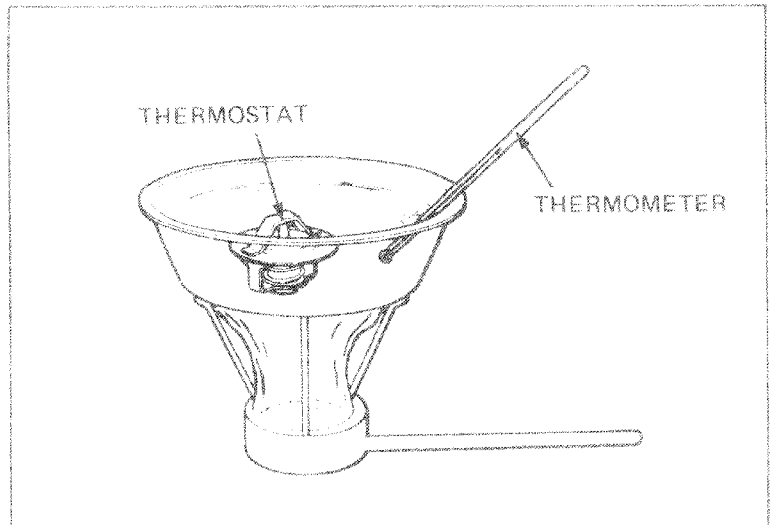

RADIATOR REMOVAL

Remove the seat and fuel tank.
Drain the coolant from the radiator.
Remove the three radiator mounting bolts.

MOUNTING BOLT

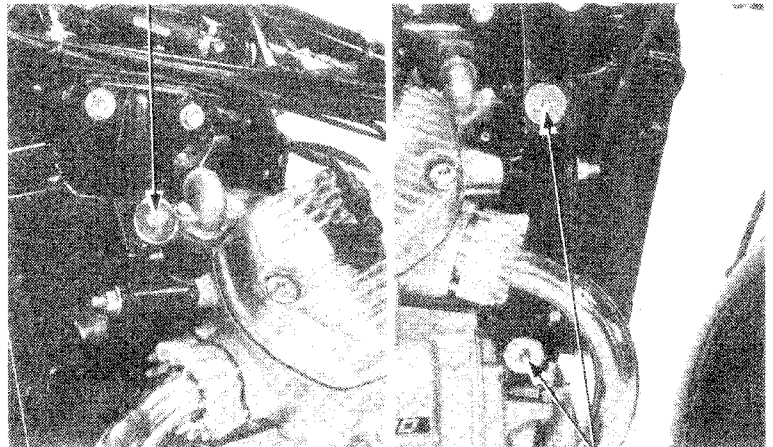

MOUNTING BOLTS

Loosen the upper and lower radiator hose bands.

UPPER HOSE BAND

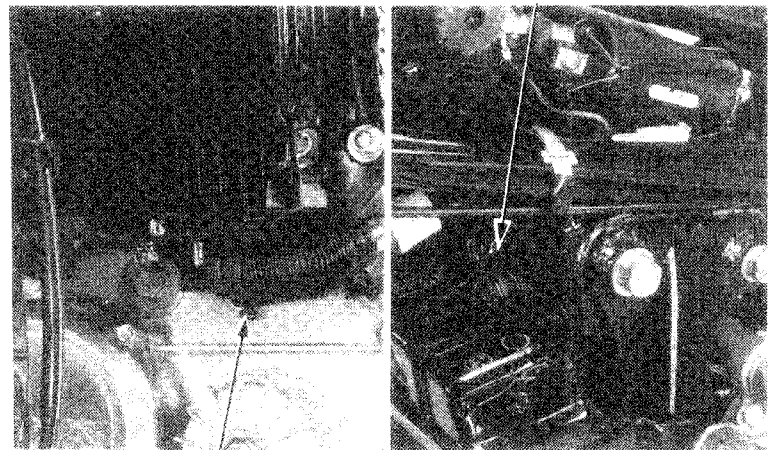

LOWER HOSE BAND



COOLING SYSTEM

Pull the radiator and disconnect the radiator hoses from the radiator.
Disconnect the siphon tube from the radiator.

CAUTION

Do not damage the radiator fins.

SIPHON TUBE

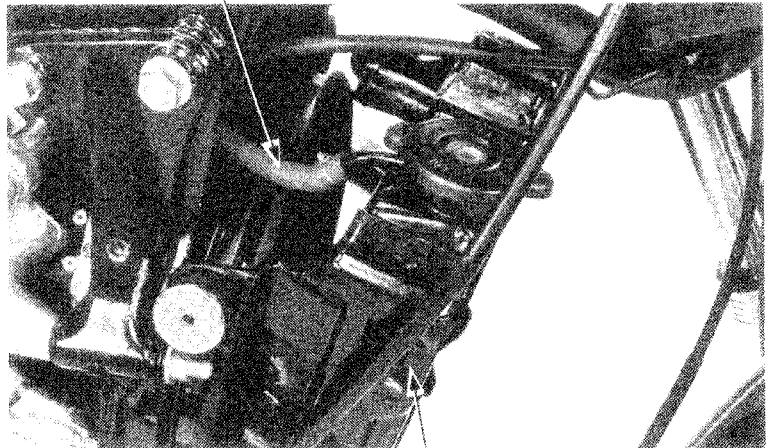

RADIATOR

COOLING FAN REMOVAL

Remove the fan bolt.
Remove the cooling fan with a ROTOR PULLER.

ROTOR PULLER 07933-2000000

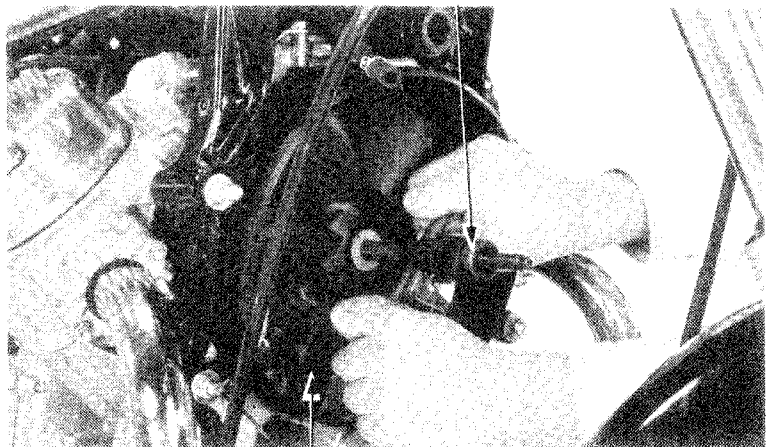

COOLING FAN

Remove the cooling fan cover by removing the four nuts

COOLING FAN COVER

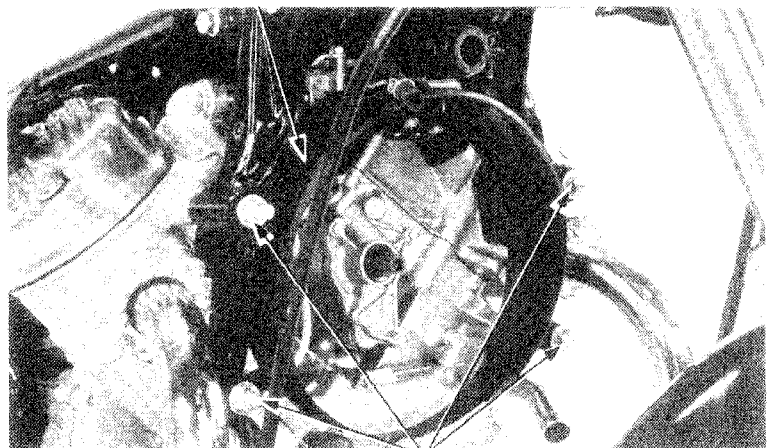

NUTS



WATER PUMP MECHANICAL SEAL REPLACEMENT

Remove the engine rear cover (Page 8-2).

REMOVAL

Drive the mechanical seal out from the inside.

NOTE

Avoid damaging the rear cover when driving the seal out.

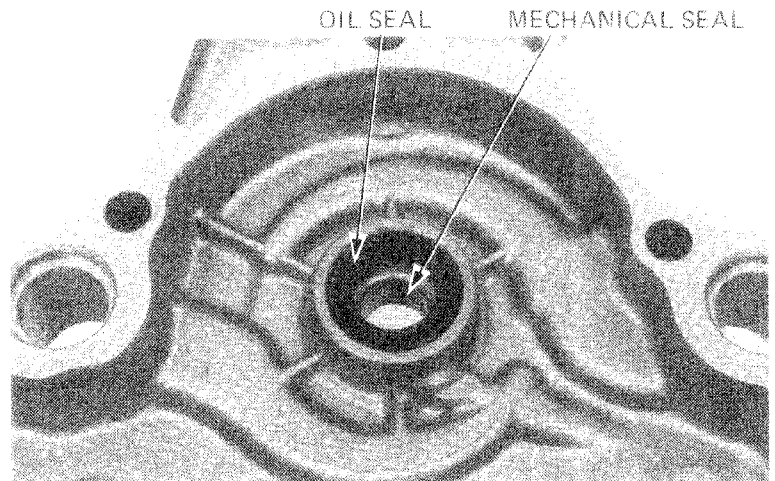

INSTALLATION

Apply a thin coat of liquid sealant to the outer edge of the mechanical seal.

NOTE

Check that the water pump drain hole is clear.

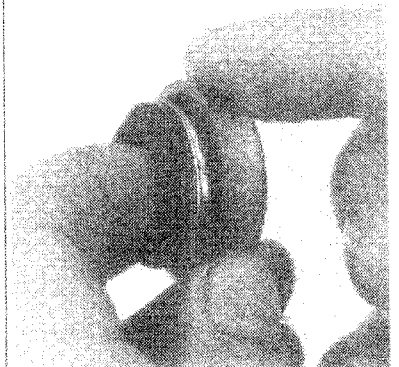
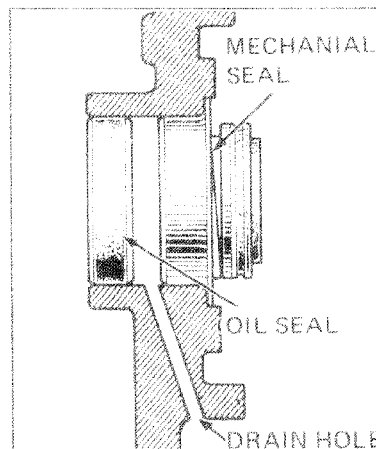

Drive the mechanical seal into position in the rear cover with the mechanical seal driver attachment and bearing driver handle.

NOTE

- Assemble the driver as follows:
Install the seal driver attachment to the driver handle. Place the mechanical seal into the attachment.
- Drive in the seal squarely.

Install the rear cover (Page 8-9).

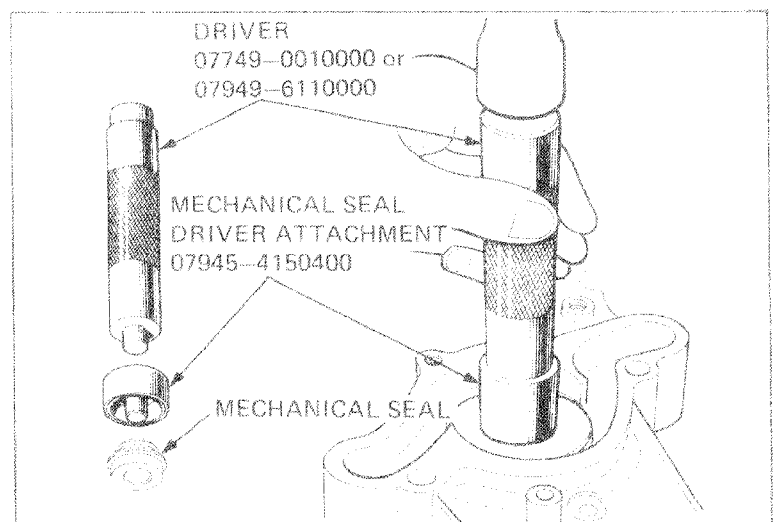

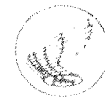

COOLING SYSTEM

THERMOSTAT INSTALLATION

Insert the thermostat into the thermostat case. Install a new O-ring on the thermostat case and attach the thermostat cover and bracket. Install the temperature unit, slide new O-rings onto the water pipes, press the water pipes into the thermostat case and elbows.

NOTE

Check that the O-rings are not dislodged.

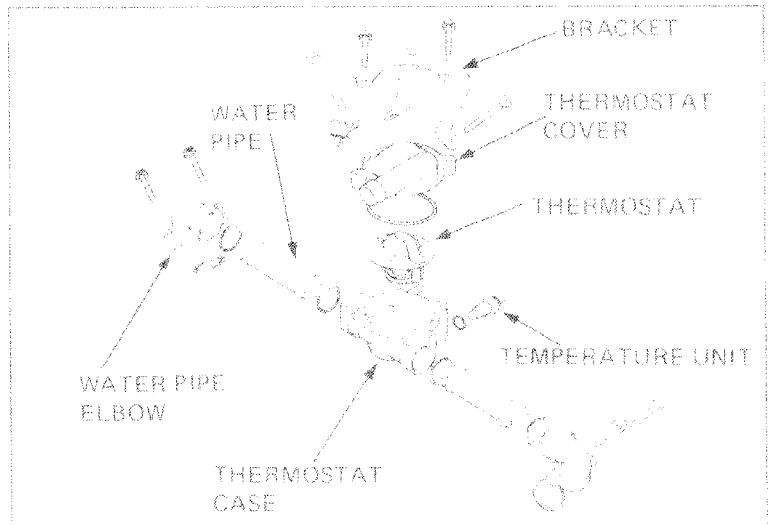

Install the thermostat case to the engine. Slide new O-rings onto the water pipes and press the water pipes into the thermostat case. Install the water pipe joints. Connect the radiator hose and tighten the hose band bolt. Install the air spoiler and route the water by-pass hose and oil pressure wire.

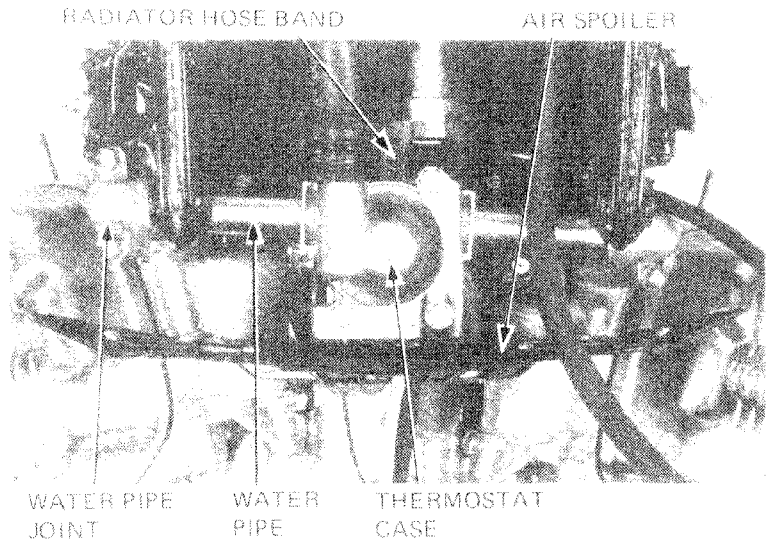

Route the water by-pass hose, water temperature and oil pressure switch wires through the hole in the air spoiler. Connect the wires and hose.

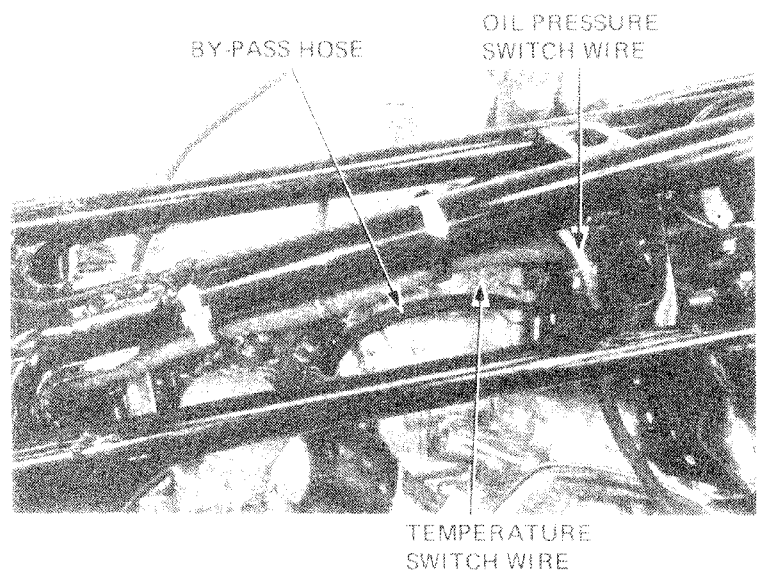



COOLING FAN INSTALLATION

Tighten the cylinder drain plug before installing the cooling fan.

Install the cooling fan cover.

Tighten the nuts.

TORQUE: 30–40 N·m (3.0–4.0 kg·m,
22–29 ft·lb)

Install the cooling fan and tighten the fan bolt.

TORQUE: 20–25 N·m (2.0–2.5 kg·m,
14–18 ft·lb)

NOTE

Make sure that the fan cover rubber seat is correctly positioned.

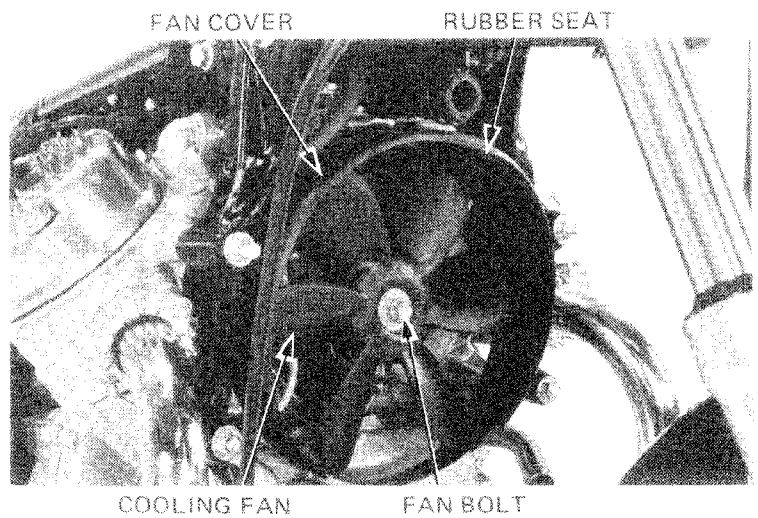

RADIATOR INSTALLATION

NOTE

Do not damage the radiator fins.

Connect the radiator lower hose to the radiator.
Connect the siphon tube.

Connect the radiator upper hose by pushing the radiator backward.

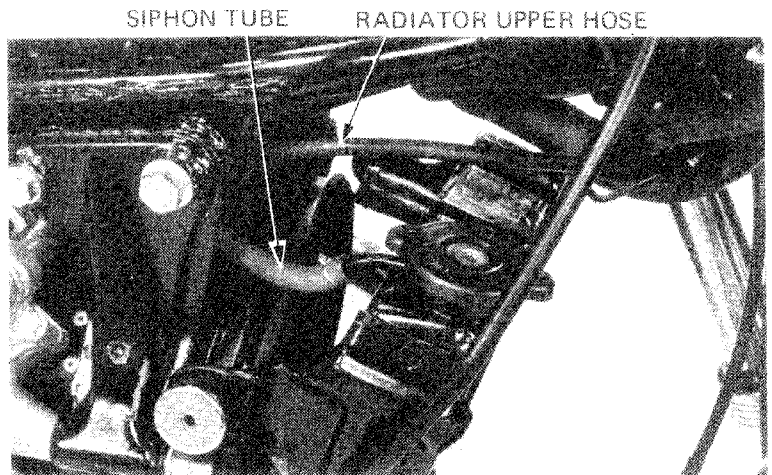

Tighten the upper and lower hose bands securely.

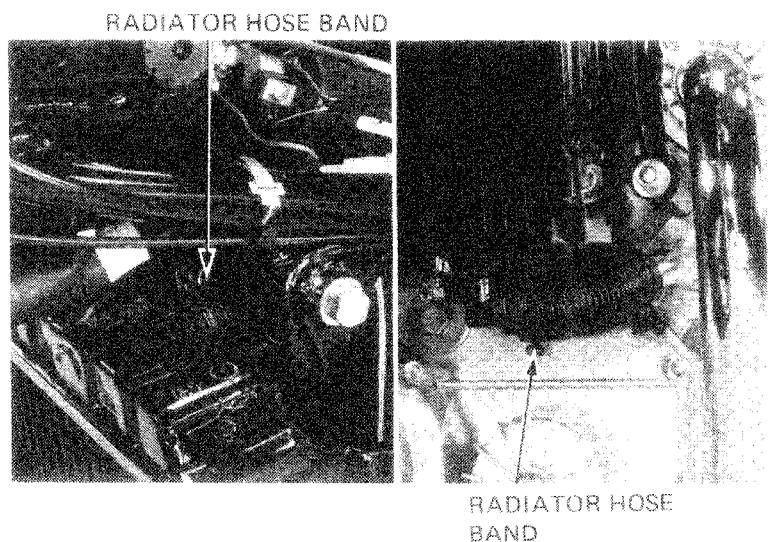



COOLING SYSTEM

Tighten the radiator mount bolts.
Install the radiator cover.

MOUNTING BOLT

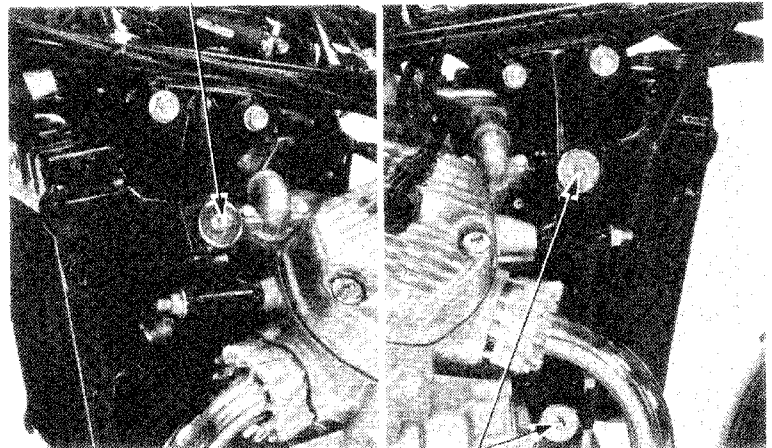

MOUNTING BOLT

Fill the system with a 50–50 mixture of distilled water and ethylene glycol.

Bleed air from the radiator

- Start the engine and run until there are no air bubbles in the coolant, and the level stabilizes.
- Stop the engine and add coolant up to the proper level if necessary.
- Reinstall the radiator cap.
- Check the level of coolant in the reserve tank and raise to the correct level if the level is low.

Pressurize the radiator, engine and hoses and check for leaks.

Repair or replace components if the system will not hold specified pressure for at least 6 seconds.

CAUTION

*Excessive pressure can damage the radiator.
Do not exceed 105 kPa (1.05 kg/cm², 14.9 psi).*

COOLING SYSTEM TESTER

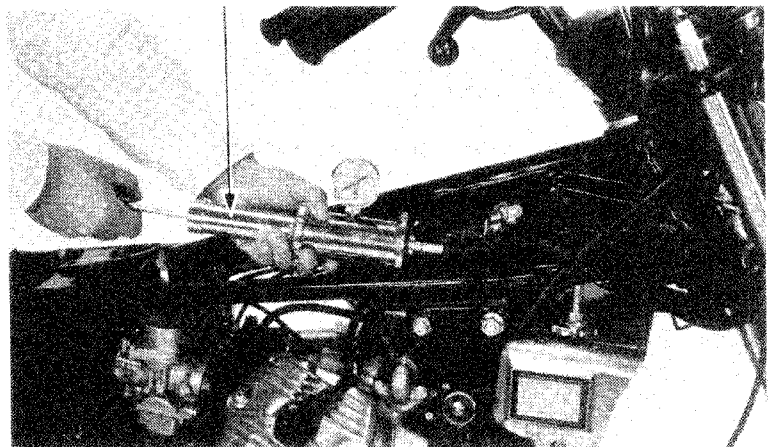



HONDA
GL500
GL500 INTERSTATE

MEMO

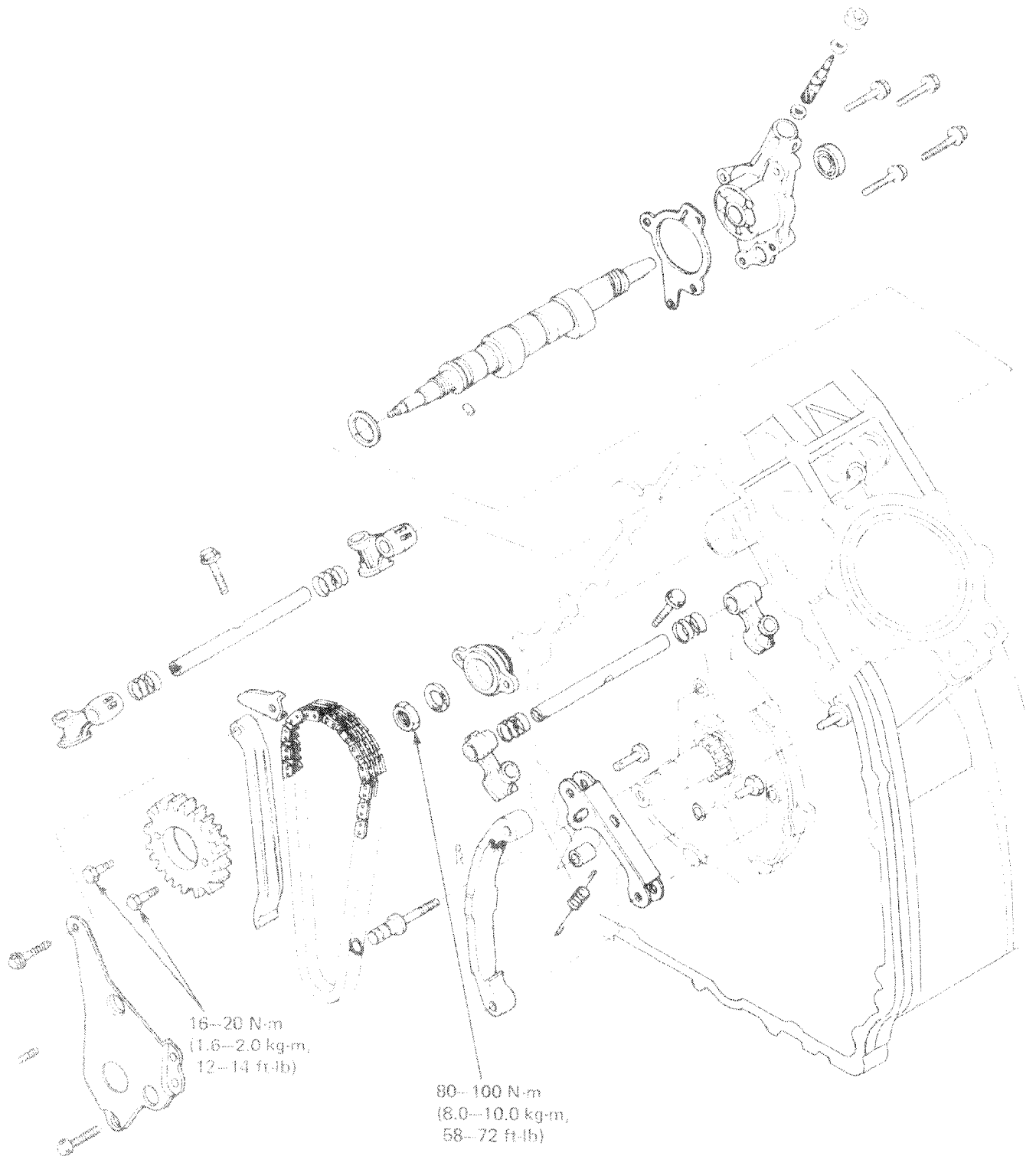



SERVICE INFORMATION	10-1
TROUBLESHOOTING	10-1
CAM CHAIN REMOVAL	10-2
CAMSHAFT REMOVAL	10-3
ROCKER ARM REMOVAL	10-5
ROCKER ARM INSTALLATION	10-6
CAMSHAFT INSTALLATION	10-7
VALVE TIMING ADJUSTMENT	10-9

SERVICE INFORMATION

GENERAL INSTRUCTIONS

- * Camshaft lubricating oil is fed from the oil filter to the front bearing through an oil control orifice located in the engine case, and to the rear bearing through an oil control orifice in the camshaft rear holder.
- * Be sure these orifices are not clogged and that the O-rings and dowel pins are in place before assembling the engine.
- * Before assembling the camshaft, lubricate the bearings with engine oil and pour 100 cc of engine oil into the engine block oil pockets to provide initial lubrication.

TOOLS

Special

- Gear holder 07924-4150000
- Lock nut socket wrench 17 x 27 mm 07907-4150000

SPECIFICATIONS

Item		Standard		Service Limit
Camshaft	Cam height	IN	37.046 (1.4585)	36.058 (1.4196)
		EX	37.015 (1.4573)	36.027 (1.4184)
	Journal O.D.	Front	21.959-21.980 (0.8645-0.8654)	21.910 (0.8526)
		Rear	25.959-26.980 (1.0220-1.0622)	25.910 (1.0201)
Rocker arms and shafts	Arm I.D.	14.016-14.027 (0.5518-0.5522)	14.046 (0.5530)	
	Shaft O.D.	13.982-14.000 (0.5505-0.5512)	13.966 (0.5510)	
	Camshaft holder I.D.	22.000-22.021 (0.8661-0.8670)	22.050 (0.8681)	
	Camshaft bearing i.D.	26.000-26.021 (1.0236-1.0244)	26.170 (1.0303)	

TORQUE VALUES

- Camshaft lock nut 80 - 100 N-m (8.0 - 10.0 kg-m, 58 - 72 ft-lb)
- Cam sprocket bolt 16 - 20 N-m (1.6 - 2.0 kg-m, 12 - 14 ft-lb)

TROUBLESHOOTING

Excessive Noise

1. Incorrect cam chain adjustment
2. Incorrect valve adjustment
3. Worn or damaged rocker arms or camshaft
4. Worn or damaged cam chain tensioner or cam chain guide
5. Worn cam sprocket teeth
6. Worn camshaft holder



CAMSHAFT/CAM CHAIN

CAM CHAIN REMOVAL

- Remove the engine. (Page 5-2).
- Remove the flywheel. (Page 8-4).
- Remove the chain guide set plate bolts.
- Remove the chain guide set plate with spring from the crank shaft.
- Free the chain guide set plate from the spring.

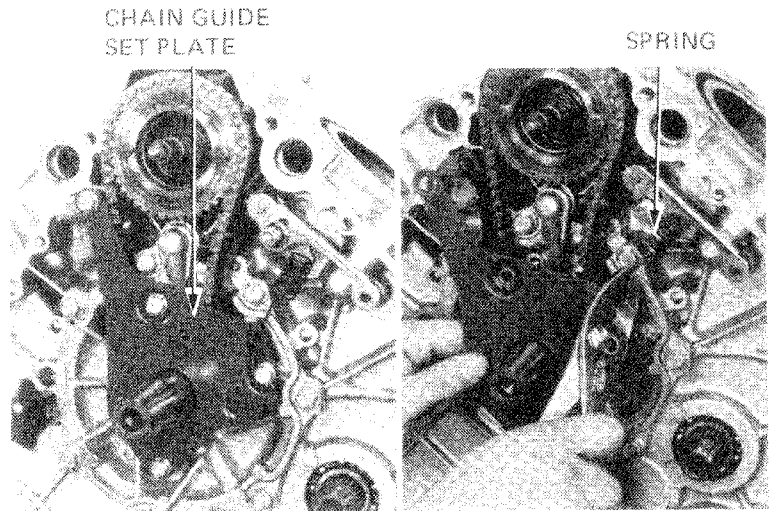

- Remove the tensioner lock bolt and collar.
- Remove the tensioner and cam chain guide.
- Check the cam chain guide and tensioner for wear or damage to the slipper surfaces.

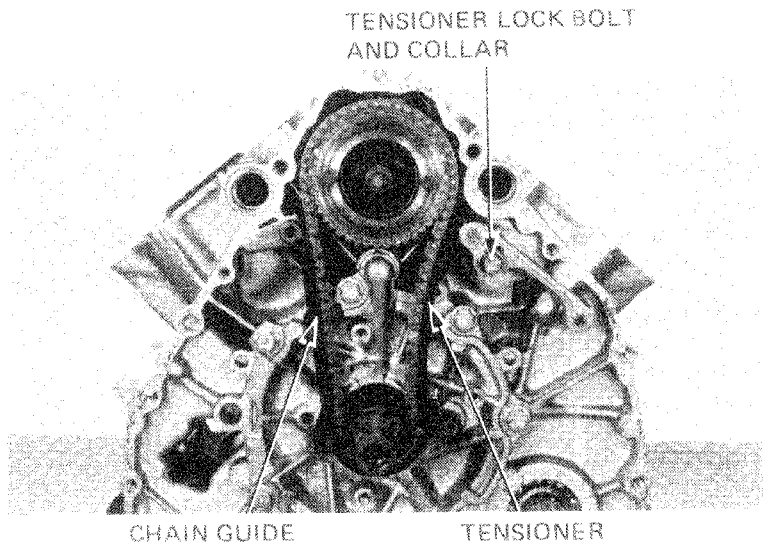

- Remove the cam sprocket dowel bolts, cam sprocket and cam chain.

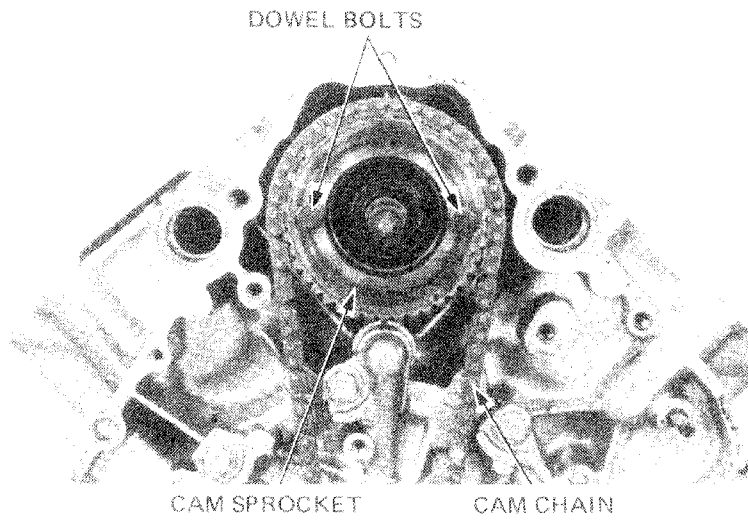



CAMSHAFT REMOVAL

Remove the cylinder head (Page 6-3).
Temporarily install the cam sprocket.
Hold the cam sprocket with a GEAR HOLDER to prevent it from turning.
Loosen the 27 mm nut and remove the cam sprocket and cam sprocket boss.

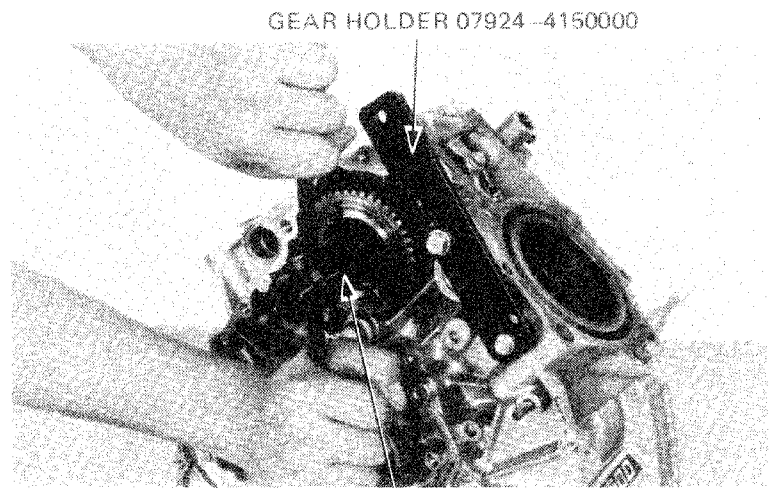

GEAR HOLDER 07924--4150000

LOCK NUT SOCKET
WRENCH 17 x 27 mm 07907--4150000

Remove the radiator and cooling fan (Page 9-5).
Remove the camshaft holder.
Remove the camshaft from the front.

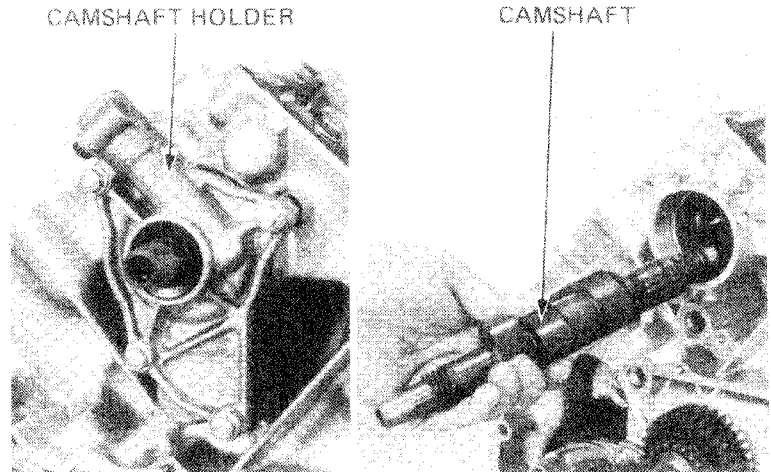

CAMSHAFT HOLDER

CAMSHAFT

CAMSHAFT INSPECTION

Measure the O.D. of each camshaft bearing journal.

SERVICE LIMIT:

FRONT: 21.910 mm (0.8526 in)

REAR: 25.910 mm (1.0201 in)

Calculate the journal and bearing clearance.

SERVICE LIMIT: 0.260 mm (0.0102 in)

Inspect the worm gear for wear or damage.

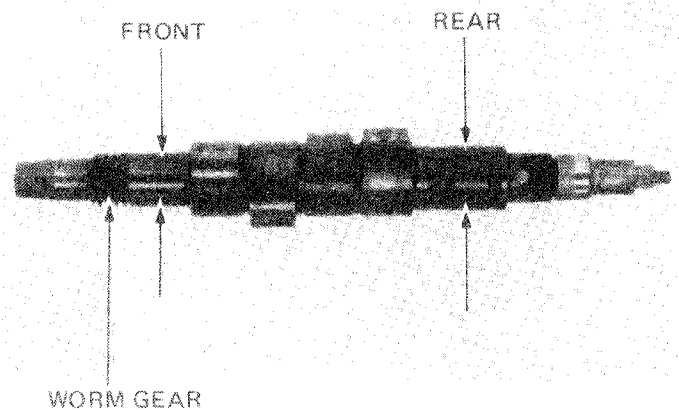

WORM GEAR

CAMSHAFT/CAM CHAIN

Measure the height of each cam lobe.
Inspect the lobes for wear or damage.

SERVICE LIMIT:

IN: 36.058 mm (1.4196 in)

EX: 36.027 mm (1.4184 in)

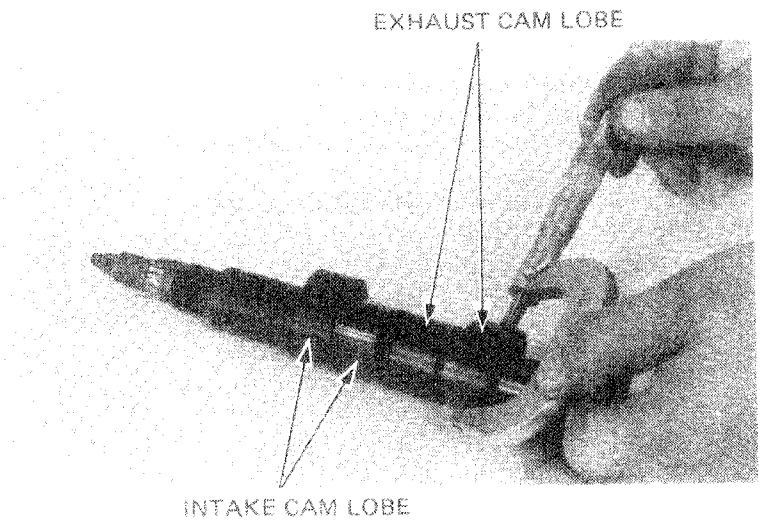

CAMSHAFT HOLDER INSPECTION

Measure the camshaft holder I.D. as shown.

SERVICE LIMIT: 22.050 mm (0.8681 in)

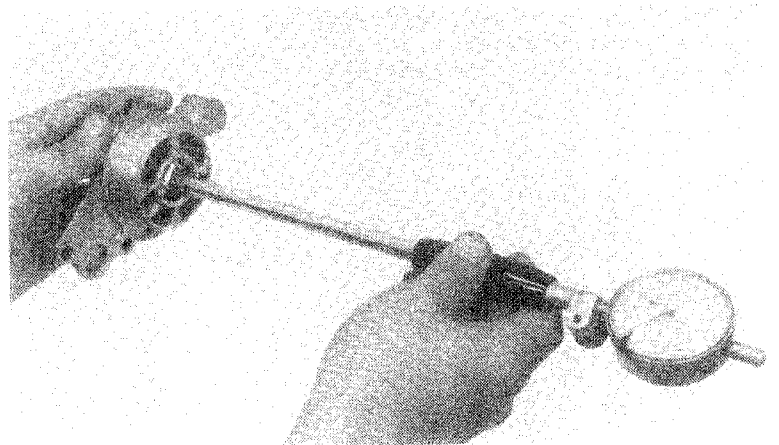

CAMSHAFT BEARING INSPECTION

Measure the bearing I.D.

SERVICE LIMIT: 26.170 mm (1.0303 in)

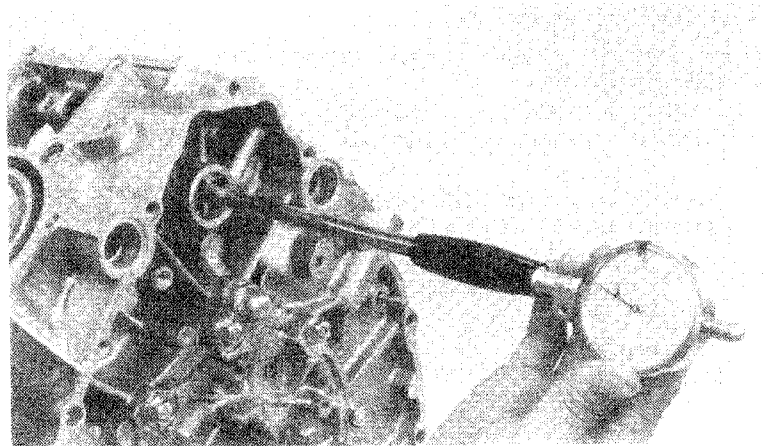



ROCKER ARM REMOVAL

Remove the rocker arm shaft lock bolts.

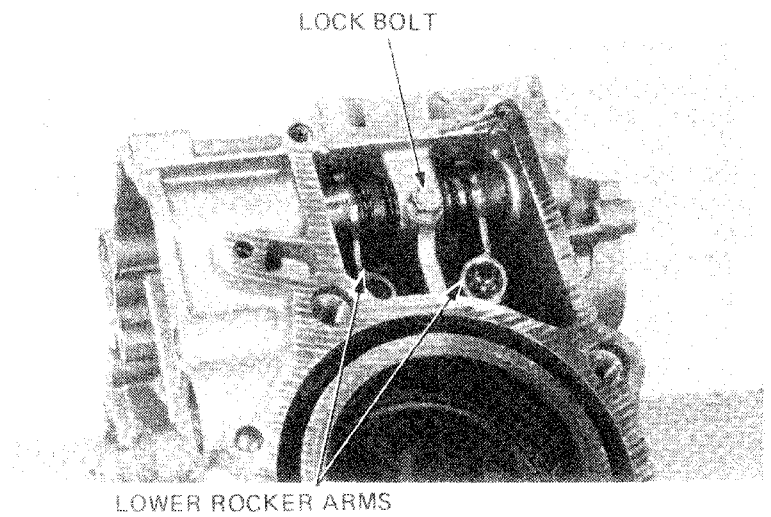

Screw a 6 mm bolt into the rocker arm shaft and remove the rocker arm shaft. Remove the rocker arm and wave washer.

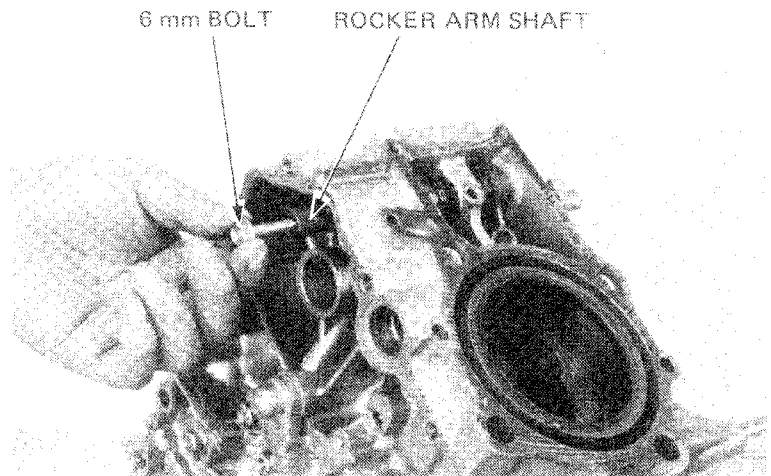

ROCKER ARM INSPECTION

Inspect the rocker arms for wear or damage to the camshaft contact surfaces, or clogged oil holes. Measure the I.D. of each rocker arm.

SERVICE LIMIT: 14.046 mm (0.5530 in)

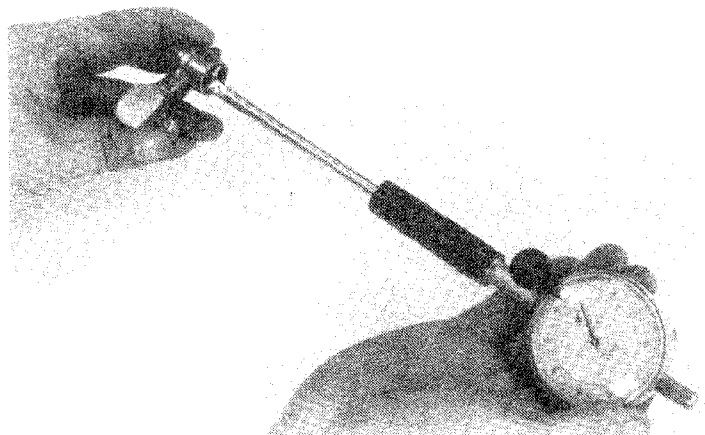



CAMSHAFT/CAM CHAIN

ROCKER ARM SHAFT INSPECTION

Measure each rocker arm shaft O.D.

SERVICE LIMIT: 13.966 mm (0.5510 in)

Inspect the shaft for wear damage.

Calculate the clearance of the shaft and the rocker arm.

SERVICE LIMIT: 0.080 mm (0.0031 in)

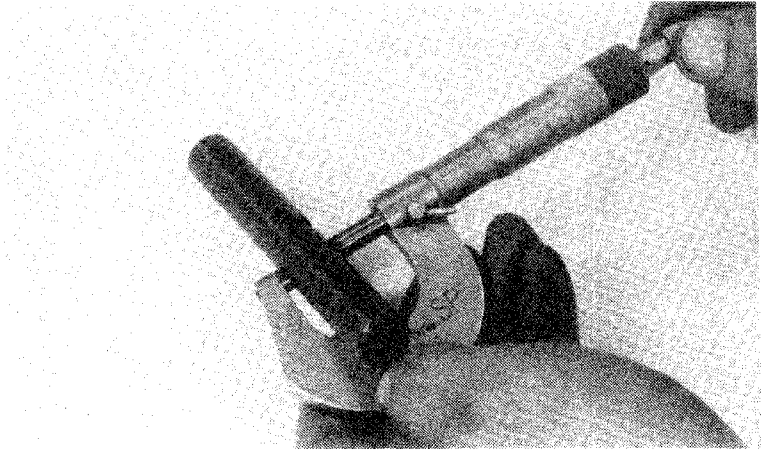

ROCKER ARM INSTALLATION

Install the rocker arms with the offset toward the inside.

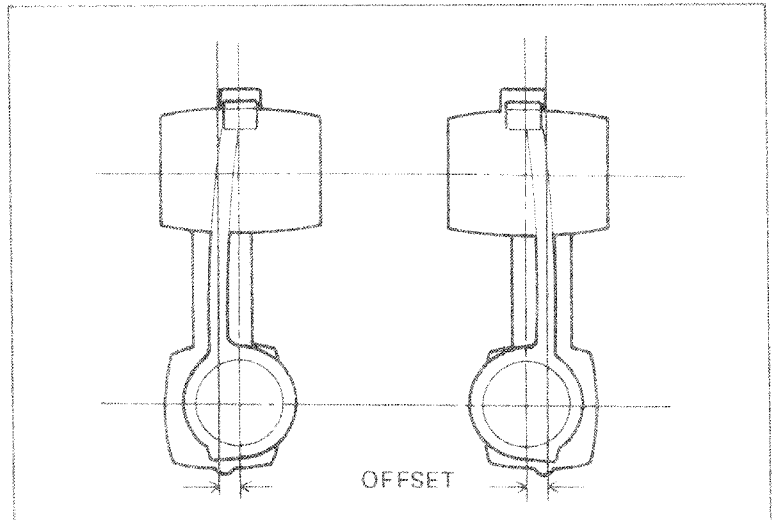

Install the rocker arms and thrust springs in the cylinder block, and then insert the rocker arm shafts.

NOTE

- Lubricate the rocker arm shafts with engine oil before installation.
- Install each rocker arm shaft with the threaded end facing the rear (cam sprocket side).

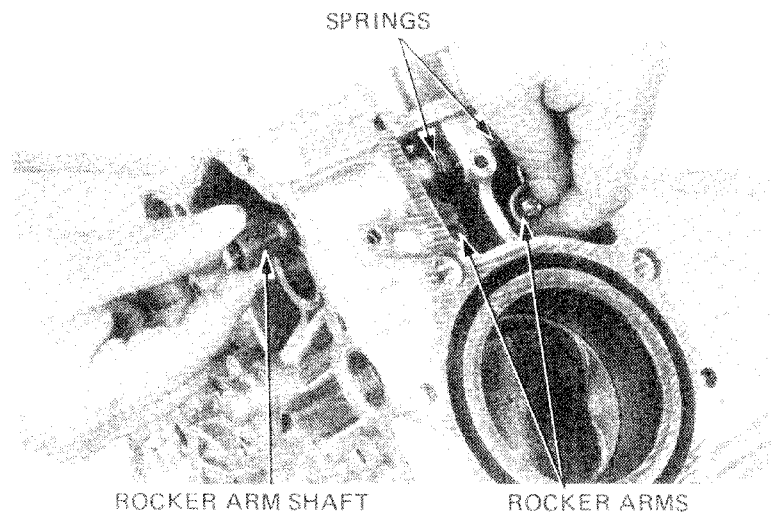



Rotate the rocker arm shaft with a screwdriver to align with the lock bolt hole. Install the lock bolt.

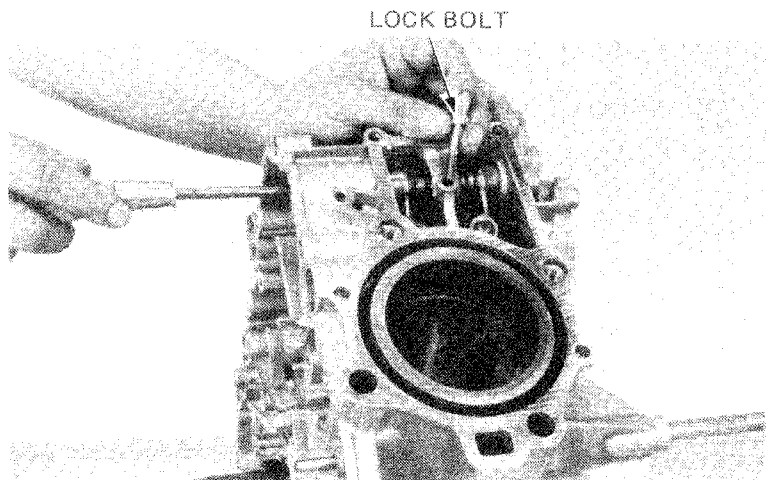

CAMSHAFT INSTALLATION

Lubricate the camshaft journals with MULTIPURPOSE NLG1 No. 2 (MoS₂ additive) GREASE. Install the camshaft thrust washer. Insert the camshaft from the front.

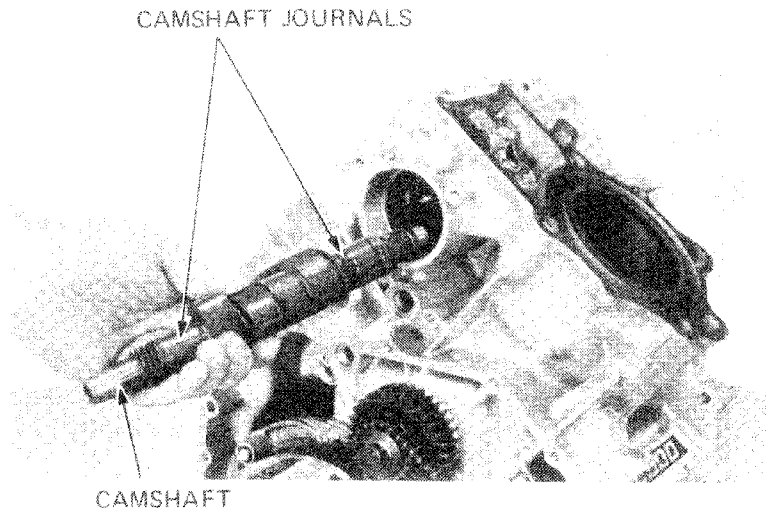

Install the camshaft holder gasket, O-ring, and collar.

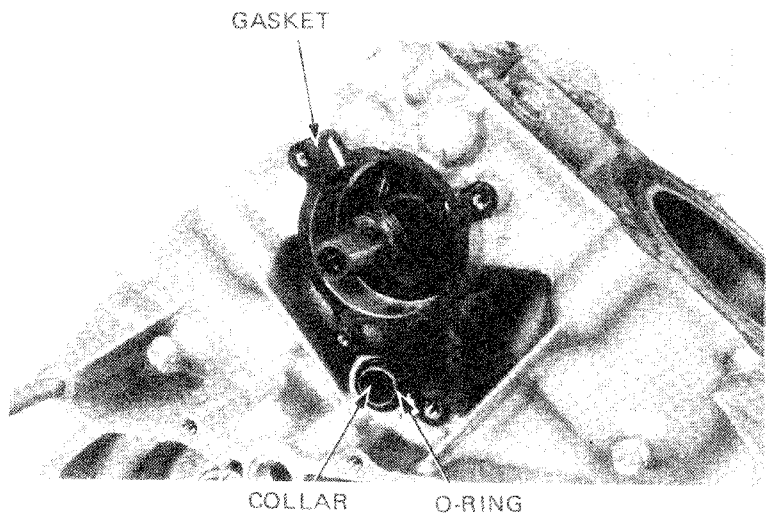

Lubricate the cam holder oil seal lip with engine oil.
Install the camshaft holder.

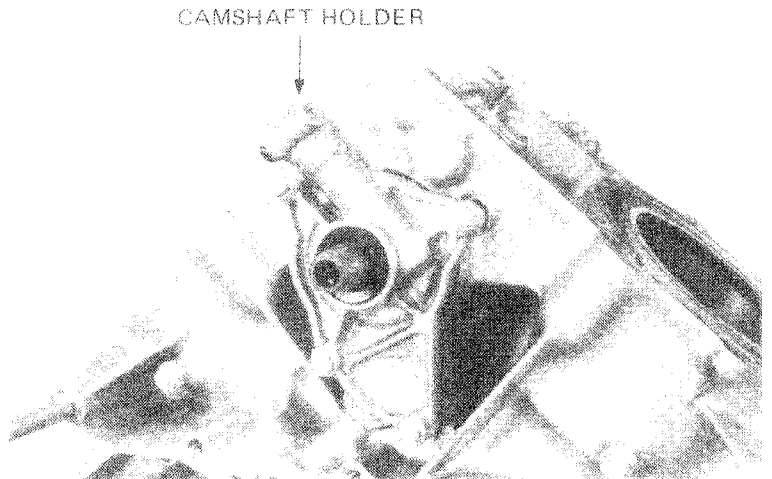

Install the cam sprocket boss, aligning the cut-out with the camshaft dowel pin.
Install the lock nut and lock washer and tighten the nut temporarily.

NOTE

Install the lock washer with the mark "OUT-SIDE" facing out.

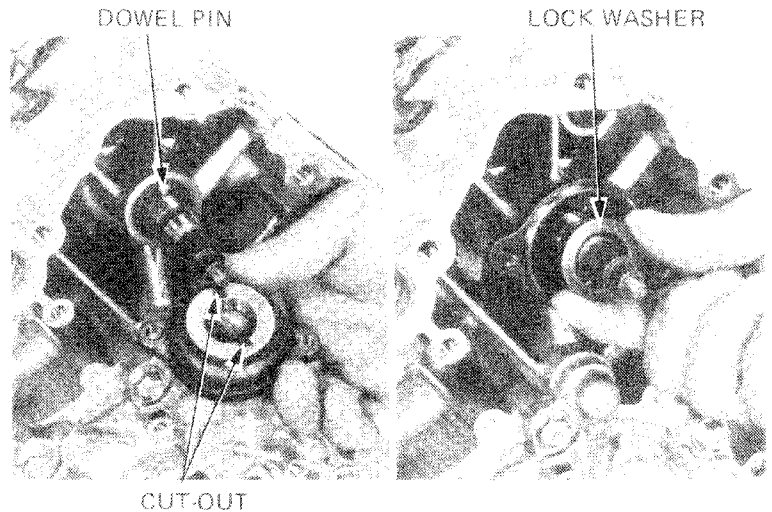

Install the cam sprocket and finger tighten the bolts.
Hold the cam sprocket with the GEAR HOLDER.
Tighten the lock nut.

**TORQUE: 80–100 N·m (8.0–10.0 kg·m,
58–72 ft·lb)**

Remove the cam sprocket.

LOCK NUT SOCKET
WRENCH 17 x 27 mm
07907-4150000

GEAR HOLDER
07924-4150000

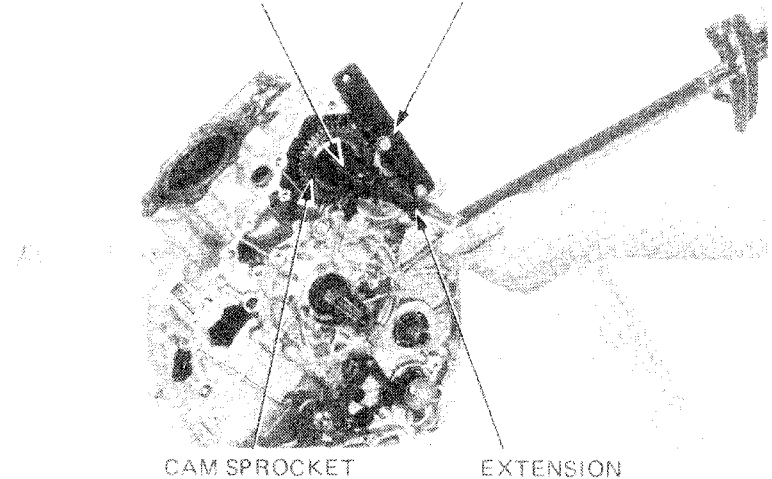



VALVE TIMING ADJUSTMENT

Align the holes in the cam sprocket boss with the aligning marks on the cylinder block.

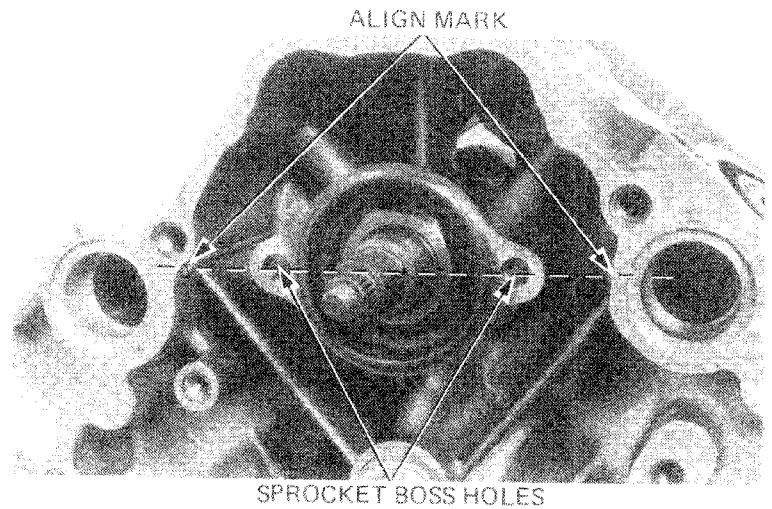

Rotate the crankshaft to bring the left piston to T.D.C.

Verify the valve timing by observing the following:

- Make sure the cam sprocket bolts are in line with the aligning marks on the cylinder block.
- Check that the flywheel woodruff key aligns with the index mark on the crankshaft cap.

NOTE

When inspecting the valve timing, push the cam chain from the right side so the tensioner-side of the chain is pulled taut.

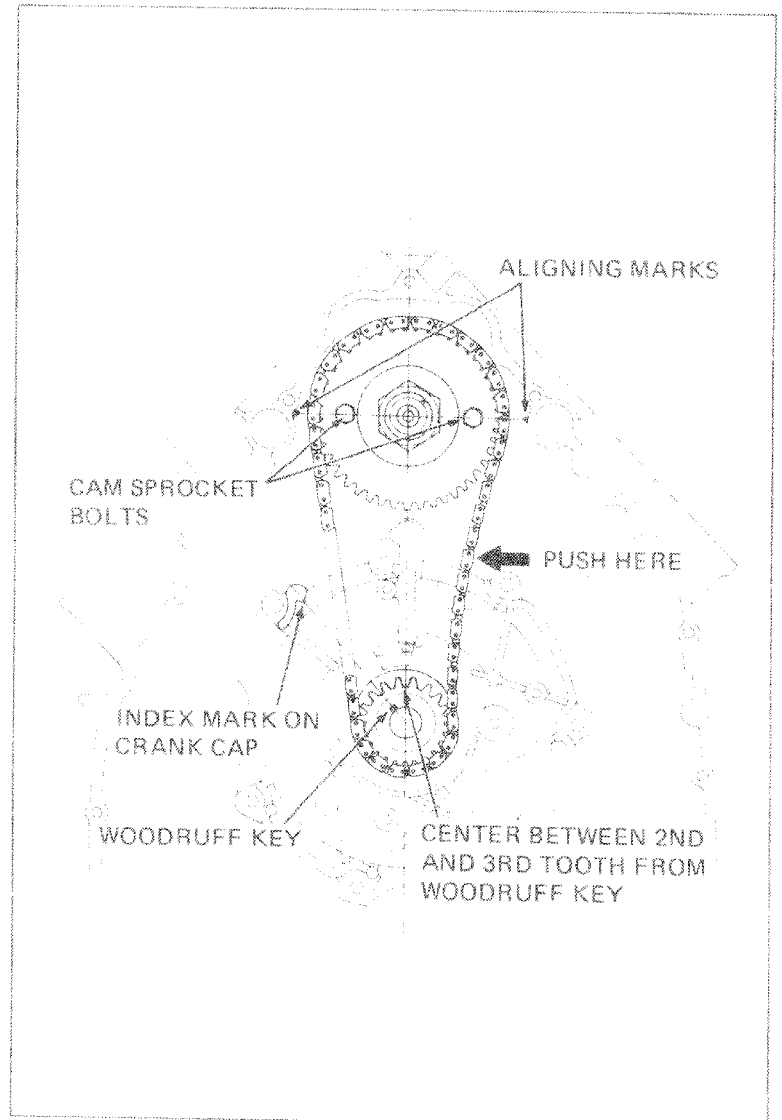

CAMSHAFT/CAM CHAIN

Hold the camshaft with the LOCK NUT SOCKET WRENCH.

Torque the cam sprocket bolts.

**TORQUE: 16–20 N·m (1.6–2.0 kg·m,
12–14 ft·lb)**

LOCK NUT SOCKET
WRENCH 17 x 27 mm 07907–4150000

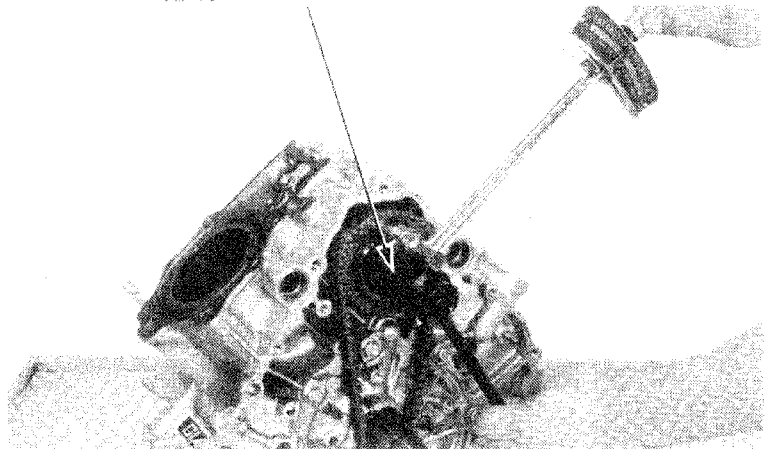

Install the cam chain tensioner.
Install the O-ring on the lock nut.
Slide the collar into the tensioner arm and install the lock bolt. Do not tighten the lock nut at this time.

TENSIONER COLLAR

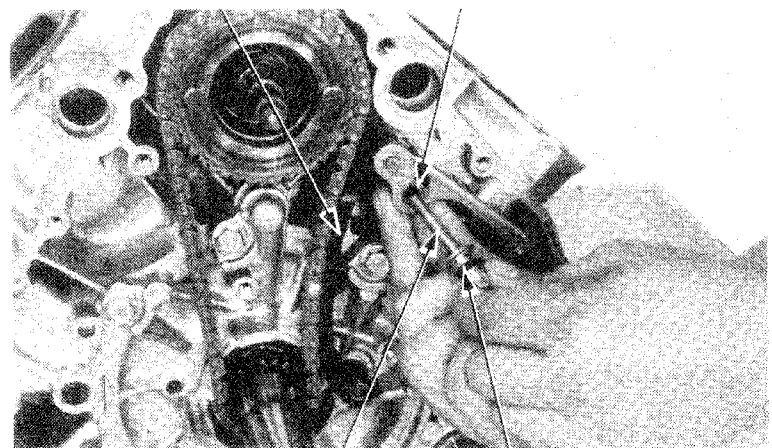

LOCK BOLT O-RING

Install the tensioner spring.
Install the cam chain guide and guide plate.

GUIDE PLATE SPRING

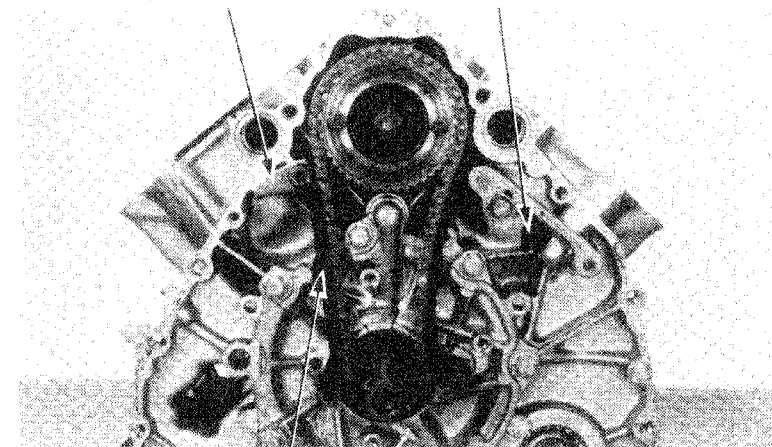

CHAIN GUIDE



Hook the spring on the chain guide set plate and install the set plate.

Torque the 6 mm bolt.

TORQUE: 8–12 N·m (0.8–1.2 kg·m, 6–9 ft·lb)

Tighten the lock bolt.

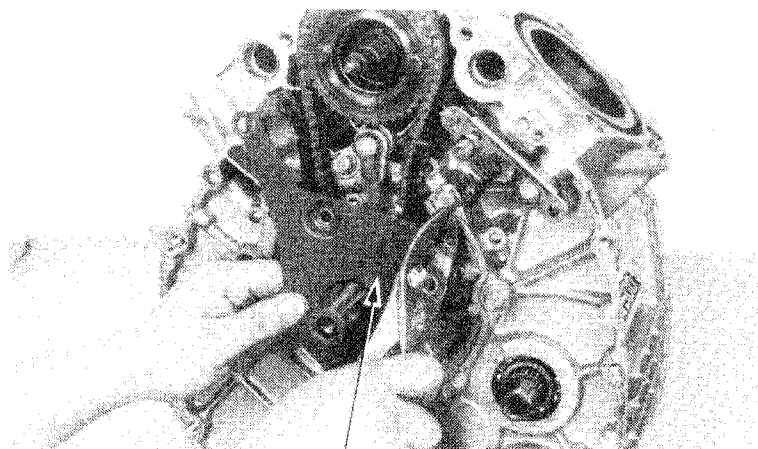

CHAIN GUIDE SET PLATE

Pour about 10 cc of engine oil into the oil pockets of the cylinder block.

Install the flywheel (Page 8-8) and the cylinder head (Page 6-14).

Adjust the valve clearance (Page 3-7).

Install the engine (See section 5).

Add the specified amount of engine oil (Section 2).

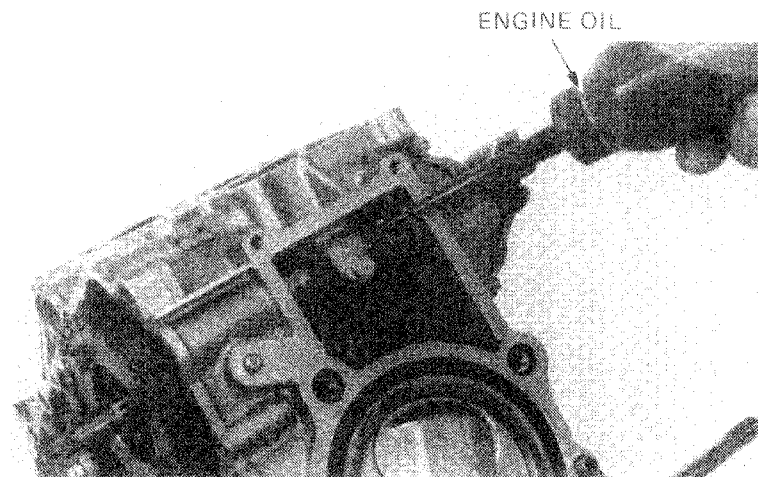



11. TRANSMISSION

SERVICE INFORMATION	11-1
TROUBLESHOOTING	11-2
GEARSHIFT LINKAGE REMOVAL	11-3
FINAL SHAFT DISASSEMBLY	11-3
FINAL SHAFT ASSEMBLY	11-4
TRANSMISSION DISASSEMBLY	11-4
TRANSMISSION ASSEMBLY	11-10
GEARSHIFT LINKAGE INSTALLATION	11-14

SERVICE INFORMATION

GENERAL INSTRUCTIONS

- Before reassembling, lubricate the M4 and M5 gears with MULTIPURPOSE NLG1 No. 2 (molybdenum disulfide additive) GREASE or an equivalent.
- Apply engine oil to the other gears.
- To service the transmission, it is necessary to remove the engine from the frame.

TOOLS

Special

Crank cap driver	07945-4150100
Bearing remover 20 mm	07936-3710600
Bearing remover handle	07936-3710100
Bearing remover waight	07936-3710200
Attachment	07946-3710200
Ball race remover/driver	07946-3290200
Attachment	07945-3330100
Driver	07947-3710000

Common

Attachment 42 x 47 mm	07746-0010300 or 07945-3330100
Driver	07749-0010000
Attachment 52 x 55 mm	07746-0010400 or 07946-3710200
Pilot 25 mm	07746-0040600
Attachment 62 x 68 mm	07746-0010500
Pilot 20 mm	07746-0040500
Attachment 32 x 35 mm	07746-0010100 or 07946-3640000 or 07946-6920100



SPECIFICATIONS

Unit : mm (in)

Item		Standard	Service Limit	
Transmission	M2, M3, M4 and M5 gear I.D.	25.020–25.041 (0.9850–0.9859)	25.10 (0.988)	
	C1 gear I.D.	24.020–24.041 (0.9457–0.9465)	24.10 (0.949)	
	C2 gear I.D.	27.520–27.541 (1.0835–1.0843)	27.60 (1.087)	
	C3 and C4 gear I.D.	25.020–25.041 (0.9850–0.9859)	25.10 (0.988)	
	C5 gear I.D.	32.000–32.025 (1.2598–1.2608)	32.10 (1.264)	
	C1 gear bushing	I.D.	20.020–20.041 (0.7882–0.7890)	20.06 (0.790)
		O.D.	23.984–24.005 (0.9443–0.9451)	23.95 (0.943)
	Mainshaft O.D.	24.940–24.959 (0.9819–0.9827)	24.91 (0.781)	
	Countershaft O.D.	At C1	19.987–20.000 (0.7869–0.7874)	19.96 (0.786)
		At C2	27.459–27.480 (1.0811–1.0818)	27.43 (1.080)
		At C3 and C4	24.959–24.980 (0.9826–0.9835)	24.93 (0.981)
		At C5	31.950–31.975 (1.2579–1.2586)	31.91 (1.256)
Gear to-bushing clearance		—	0.15 (0.006)	
Shift drum	O.D.	34.950–34.975 (1.3760–1.3770)	34.90 (1.374)	
	I.D.	35.00 –35.025 (1.3780–1.3789)	35.06 (1.380)	
Shift fork	Claw thickness	5.930 –6.000 (0.233 –0.236)	5.50 (0.217)	
	I.D.	13.000–13.018 (0.5118–0.5125)	13.05 (0.514)	
Fork shaft	O.D.	12.966–12.984 (0.5105–0.5112)	12.95 (0.510)	
Final shaft spring	Free length	73.0 (2.87)	72.0 (2.83)	

TROUBLESHOOTING

Hard to Shift

- Improper clutch adjustment: too much free play
- Shift forks bent
- Shift shaft bent
- Shift fork claw bent
- Shift drum cam grooves damaged
- Shift guide pin damaged

Transmission Jumps Out of Gear

- Gear dogs worn
- Shift shaft bent
- Shift drum stopper broken
- Shift forks bent

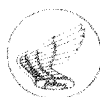

GEARSHIFT LINKAGE REMOVAL

Remove the engine (Page 5-2).
Remove the engine front cover (Page 7-9).
Remove the rear cover (Page 8-2).
Remove the rear final shaft.
Remove the gearshift spindle and shift spring.
Remove the gearshift arm.

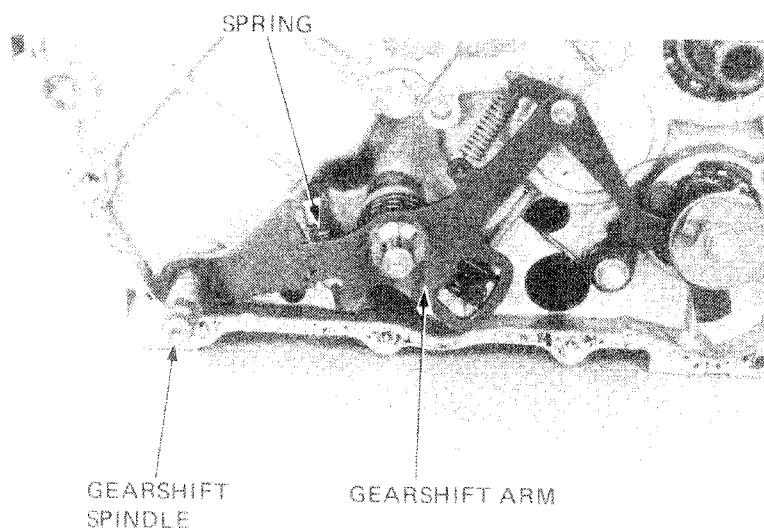

Remove the shift drum stopper bolt.
Remove the shift drum stopper arm.
Remove the neutral switch plate, shift drum stopper plate, gearshift drum pin, and collar.

NOTE

Do not disassemble the shift drum plates and pin except when replacement is necessary.

Check all removed parts for wear or damage.

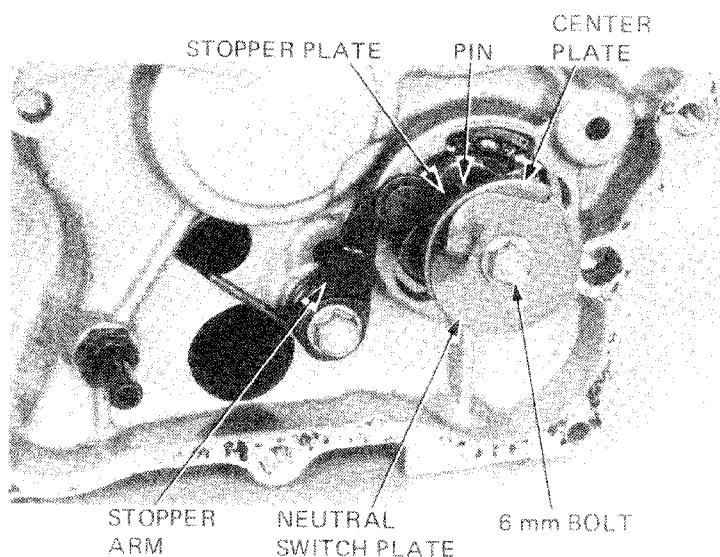

FINAL SHAFT DISASSEMBLY

Compress the spring with a press and CRANK CAP DRIVER and remove the spring cotters.
Remove the spring retainer, damper lifter and cam from the shaft.

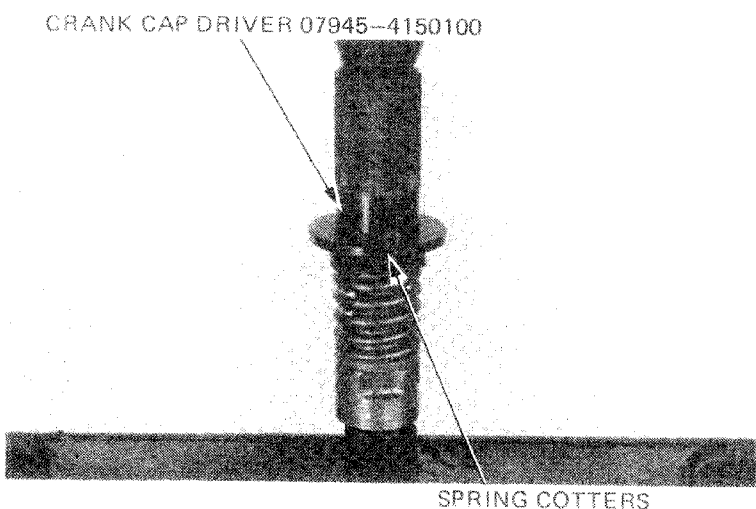



TRANSMISSION

Measure the damper spring free length.
SERVICE LIMIT: 72.0 mm (2.83 in)

Inspect the damper lifter, shaft, and retainer for wear or damage.

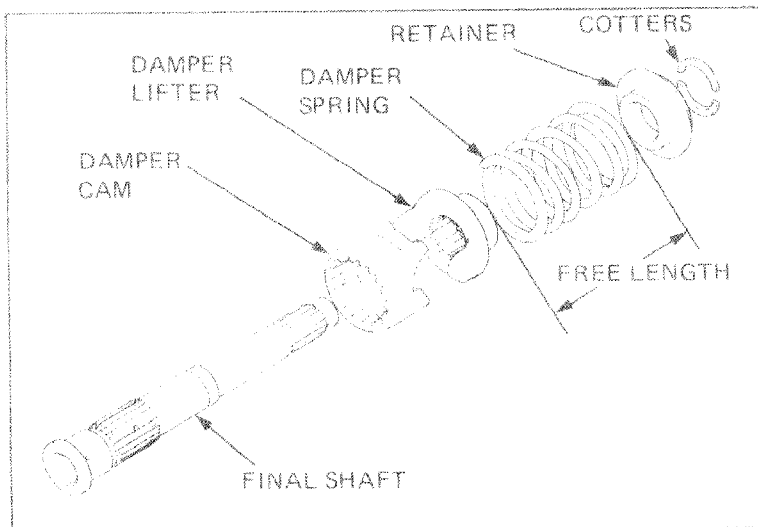

FINAL SHAFT ASSEMBLY

Slide the lifter, spring and retainer over the shaft. Compress the spring in the CRANK CAP DRIVER and install the spring cotters.

NOTE

Make sure that the cotters are properly seated.

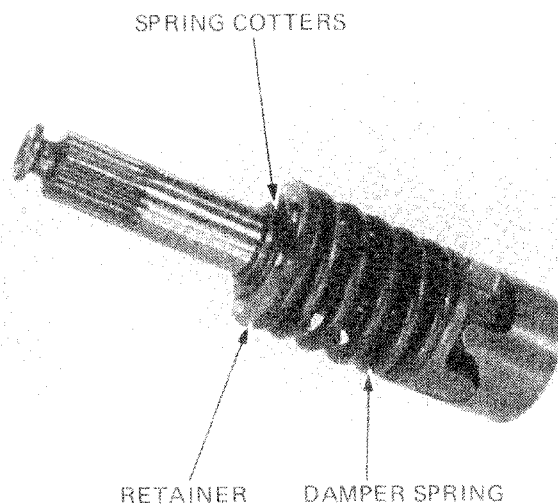

TRANSMISSION DISASSEMBLY

Remove the engine front cover and remove the clutch as an assembly (See section 7).
Remove the oil separator.

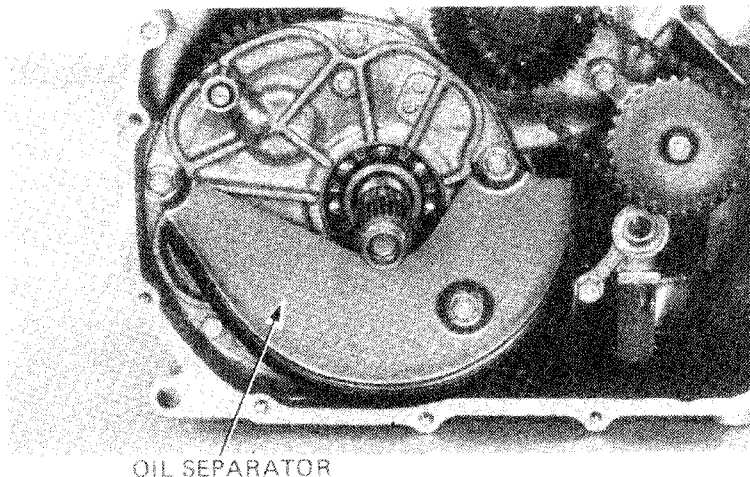



Remove the transmission holder bolts

TRANSMISSION HOLDER

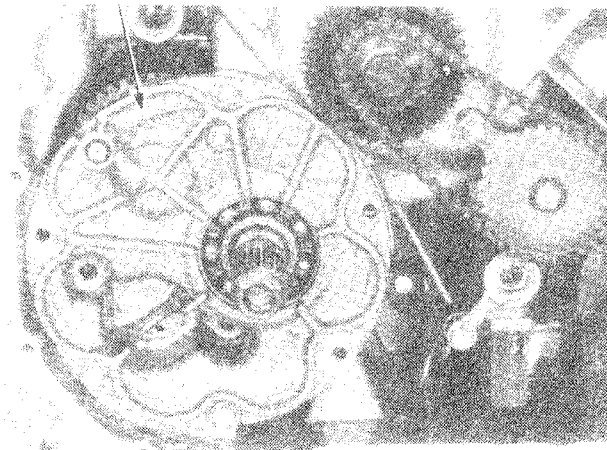

Align the projection on the stopper plate with the cut out in the engine case by rotating the shift drum.

STOPPER PLATE

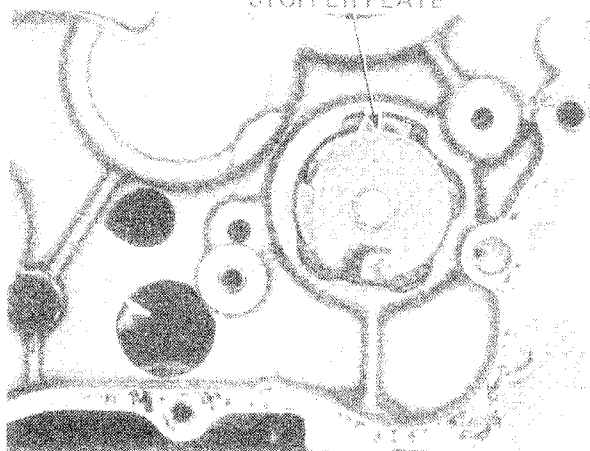

Drive the ends of the countershaft and shift drum carefully and evenly with a soft hammer until the transmission holder is clear of the engine case.

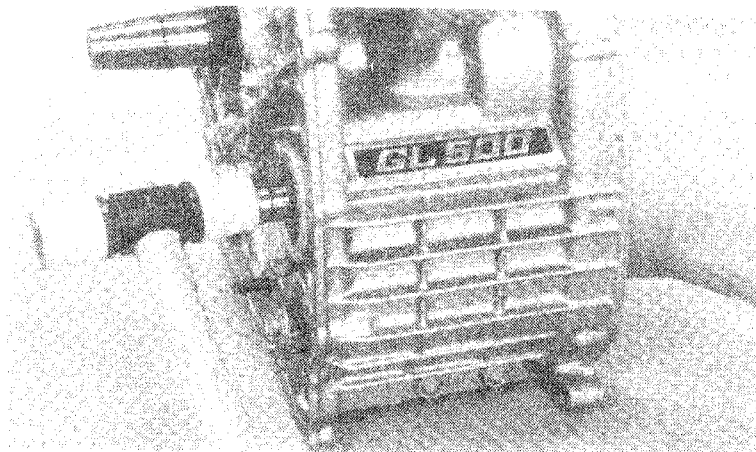



TRANSMISSION

Remove the transmission assembly from the engine case.

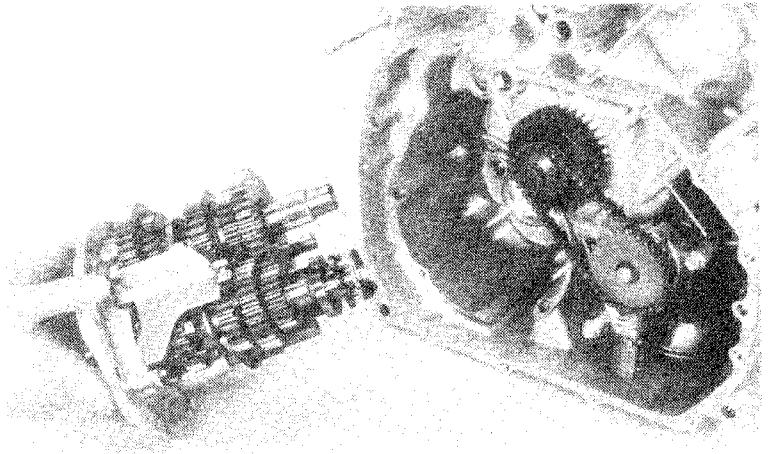

Remove the shift fork shafts.
Remove the shift forks and the guide pins.
Remove the shift drum.

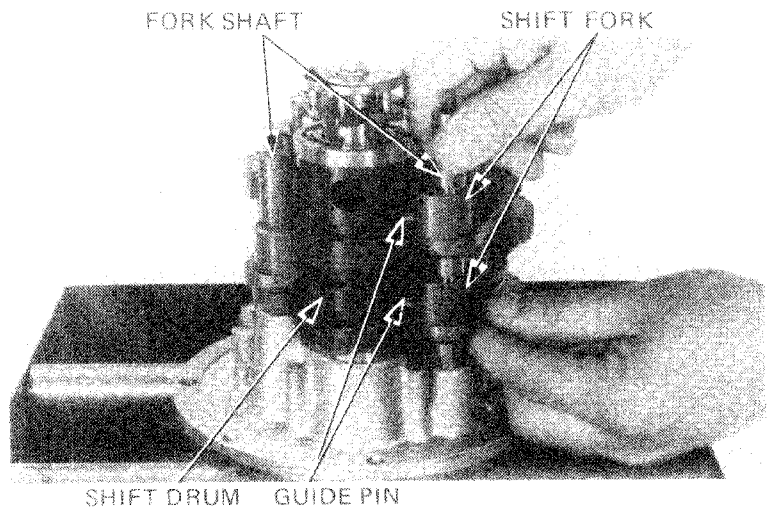

Remove 2nd and 5th gears from the countershaft and mainshaft.

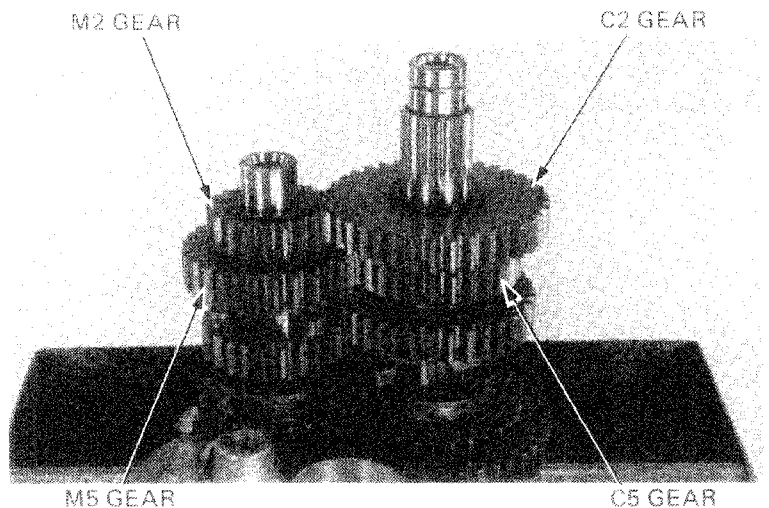



Disassemble the countershaft.

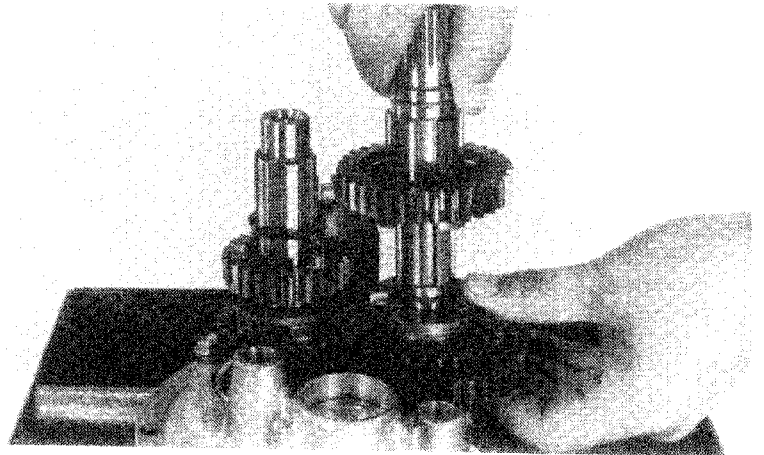

Remove the mainshaft, lightly tapping the end of it with a soft hammer.
Remove the gears by prying off the snap ring.

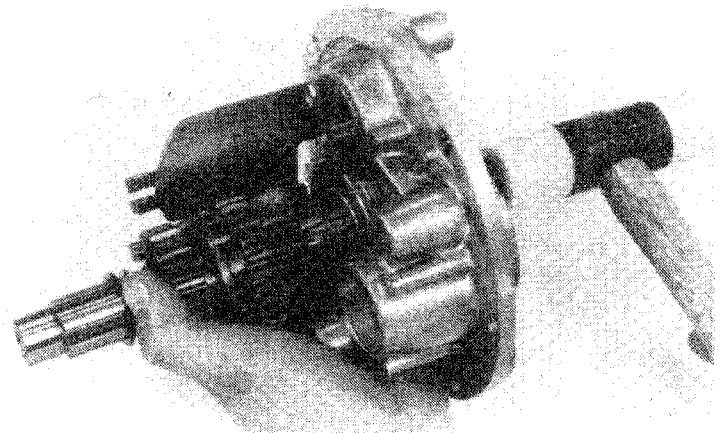

Inspect each holder bearing for wear or damage. They should rotate smoothly and be free of play or rattle.
Remove the bearings from the transmission holder.

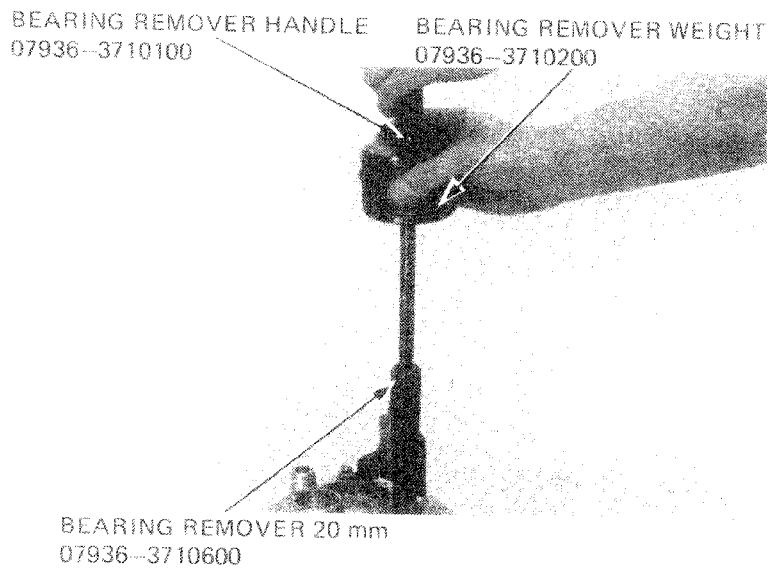



TRANSMISSION

Remove the mainshaft, countershaft bearings and oil guide plates.

NOTE

Bearings should be replaced if removed from the case.

TOOLS

MAINSHAFT BEARING
BEARING REMOVER (20 mm)
07936-3710600
BEARING REMOVER HANDLE
07936-3710100
BEARING REMOVER WEIGHT
07936-3710200

COUNTERSHAFT
BEARING

MAINSHAFT
BEARING

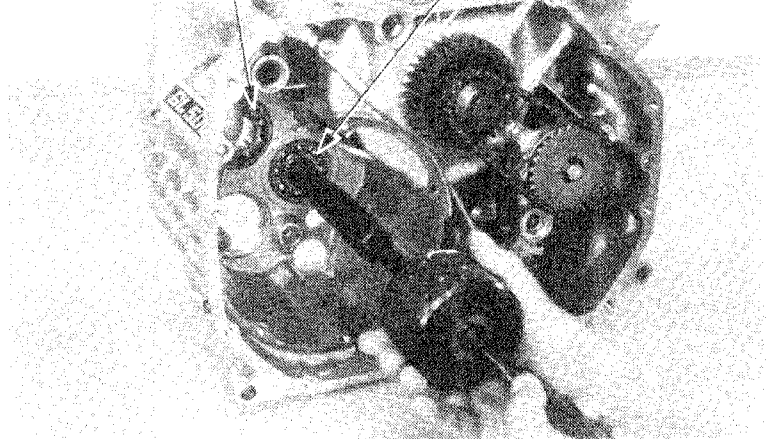

TRANSMISSION INSPECTION

Check the gears for freedom of movement and rotation on the shaft.

Examine the gear dogs and slots for evidence of abnormal wear.

Measure each gear I.D. If any gear exceeds the limit, the gear must be replaced.

SERVICE LIMITS:

M2, M3, M4 and M5 GEARS	25.10 mm (0.988 in)
C1 GEAR	24.10 mm (0.949 in)
C2 GEAR	27.60 mm (1.087 in)
C3 and C4 GEARS	25.10 mm (0.988 in)
C5 GEAR	32.10 mm (1.264 in)

Measure the countershaft low gear (C1) bushing I.D. and O.D.

SERVICE LIMITS:

O.D.: 23.95 mm (0.943 in)
I.D.: 20.06 mm (0.790 in)

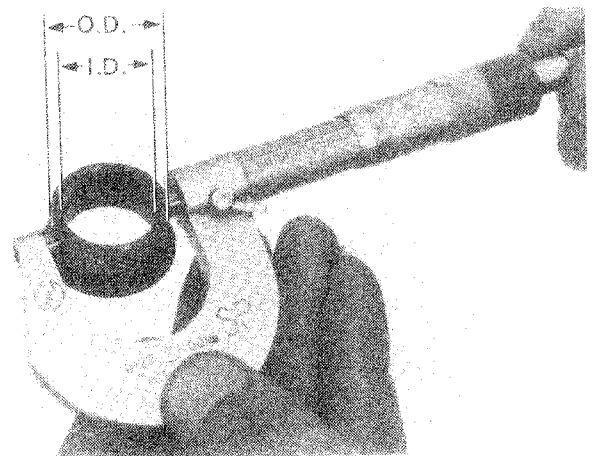
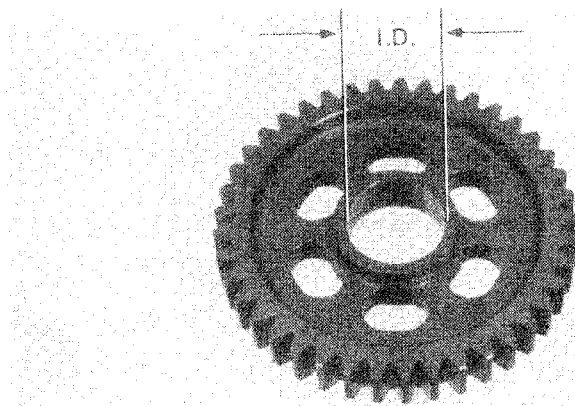



Measure and record the O.D. of the mainshaft and countershaft at the locations shown.

SERVICE LIMITS:

- A : 27.43 mm (1.080 in)
- B : 31.91 mm (1.256 in)
- C : 24.93 mm (0.982 in)
- D : 19.96 mm (0.786 in)
- E : 24.91 mm (0.781 in)
- F : 24.91 mm (0.781 in)

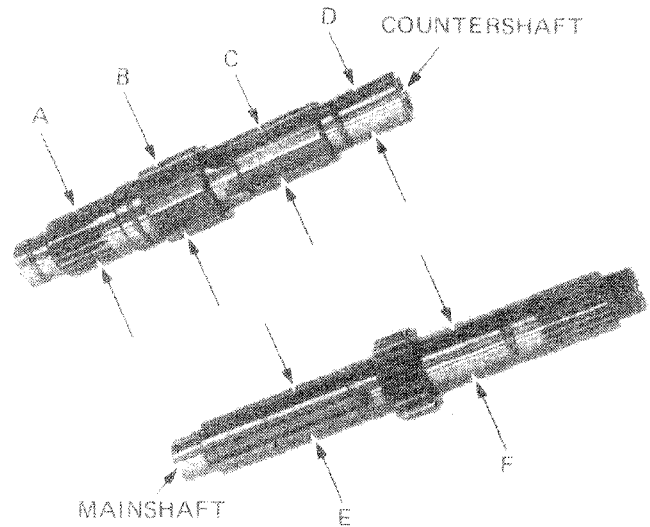

Calculate the clearance between the gear and gear shaft or bushing.

SERVICE LIMIT: 0.15 mm (0.0059 in)

Measure the shift fork I.D. and claw thickness.

SERVICE LIMIT: 13.05 mm (0.514 in)

Measure the shift fork shaft O.D.

SERVICE LIMIT: 12.95 mm (0.510 in)

Measure the shift fork claw thickness.

SERVICE LIMIT: 5.50 mm (0.217 in)

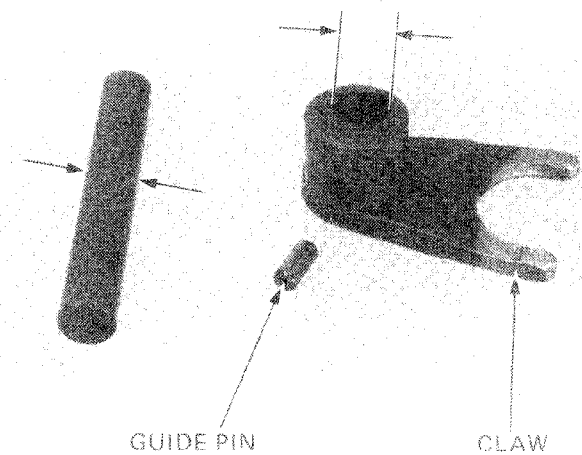

Measure the transmission holder I.D.

SERVICE LIMIT: 35.06 mm (1.380 in)

Inspect each holder bearing for wear or damage. Spin the bearing by hand. Bearings must be replaced if they are noisy or have excessive play.

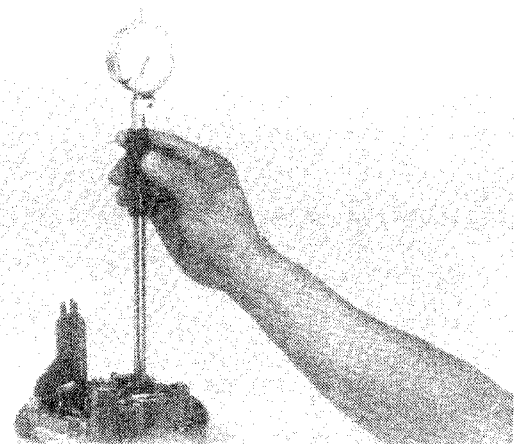



TRANSMISSION

TRANSMISSION ASSEMBLY

Install the oil guide plate in the mainshaft bearing hole.

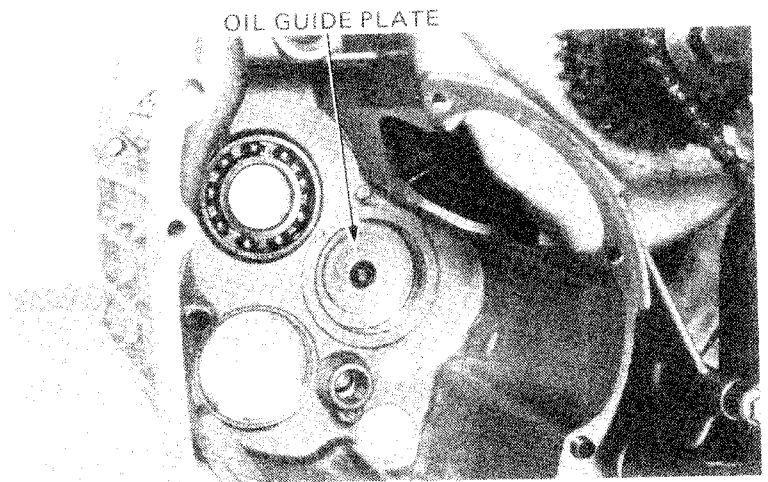

OIL GUIDE PLATE

Install the mainshaft and countershaft bearings into the case.

TOOLS

MAINSHAFT BEARING

- Attachment 42 x 47 mm
- Driver

COUNTERSHAFT BEARING

- 52 x 55 mm
- Pilot 25 mm
- Driver

DRIVER 07942-3710000 (Mainshaft)
07749-0010000 (Countershaft)

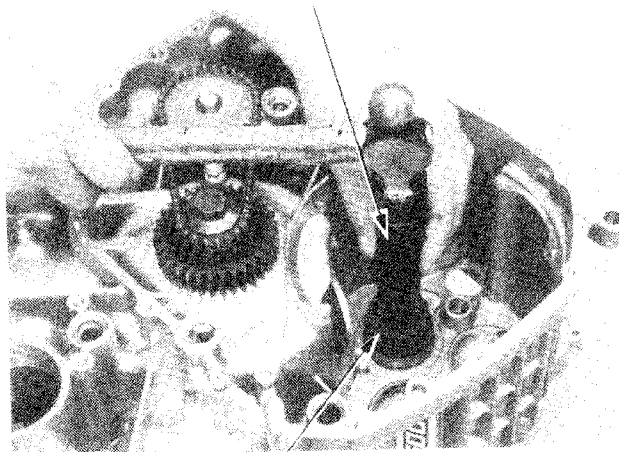

ATTACHMENT

Install the transmission holder bearing.

NOTE

Support the transmission holder above the workbench to prevent damaging it.

TOOLS

MAINSHAFT BEARING

- Attachment 62 x 68 mm
- Pilot 25 mm
- Driver

COUNTERSHAFT BEARING

- Attachment 32 x 35 mm
- Pilot 20 mm
- Driver

DRIVER 07749-0010000

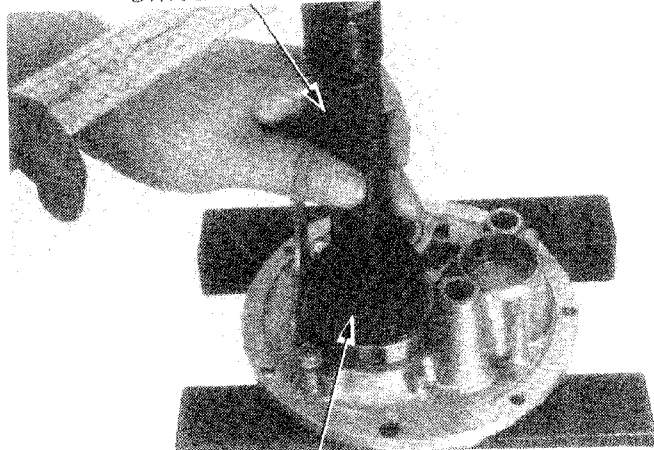

ATTACHMENT AND PILOT



Assemble the mainshaft and countershaft.

NOTE

- Check the gears for freedom of movement or rotation.
- Check that all circlips are seated in their grooves.
- Lubricate the sliding surfaces of the gears with engine oil.

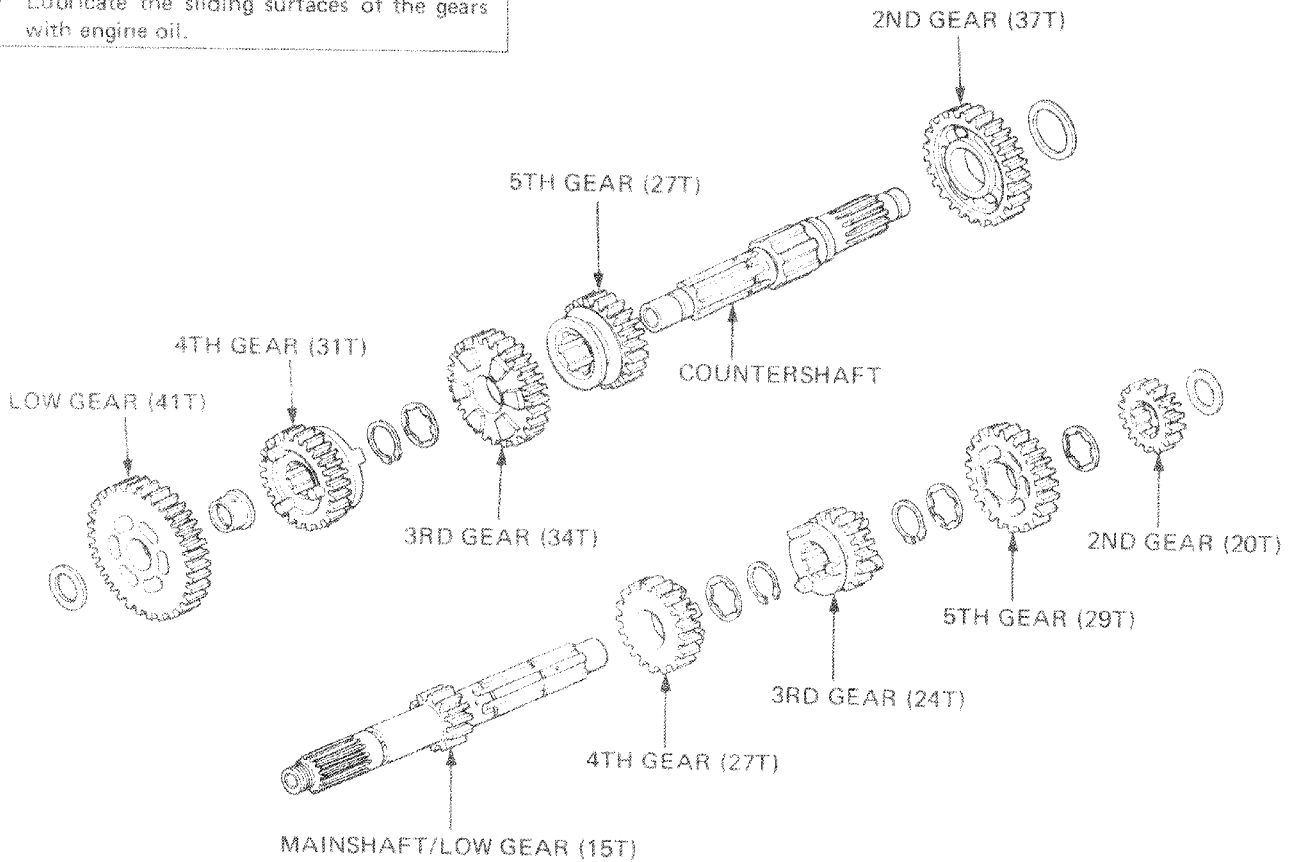

Insert the mainshaft assembly into the holder bearing until it seats lightly.

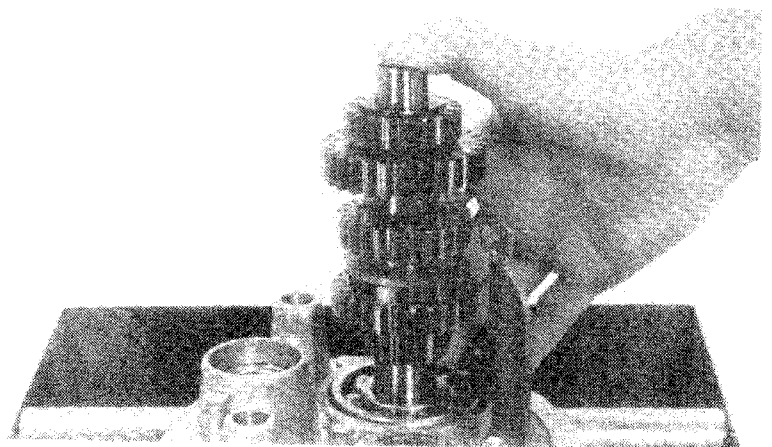



TRANSMISSION

Insert the countershaft assembly into the bearing holder.
Check the engagement of the gears on the countershaft and mainshaft.

NOTE

During installation, hold the thrust washer to prevent it from falling.

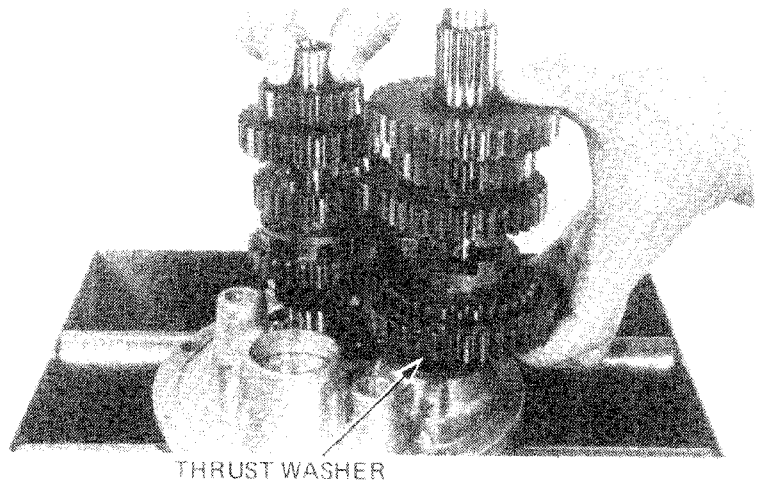

Press the gear assembly into position by lightly tapping the mainshaft with a soft hammer.

NOTE

Hold the countershaft low gear to prevent it from coming off.

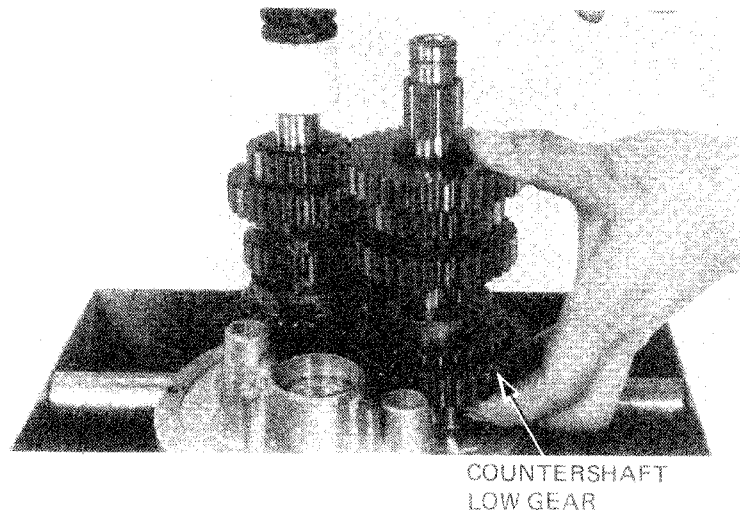

Install the shift drum.
Insert a guide pin into each shift fork.
Engage the shift forks with the gears and shift drum groove.
Install the shift fork shafts.

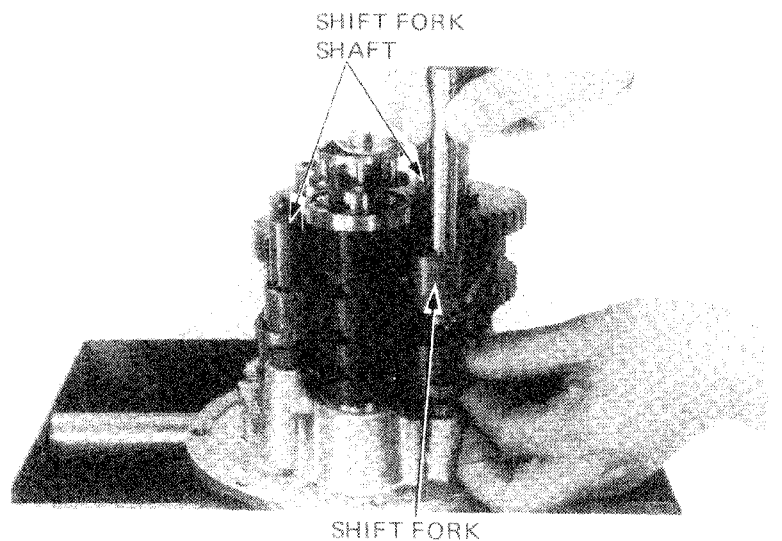

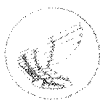

Place the transmission in neutral.
Insert the transmission assembly into the engine case.

NOTE

Align the projection on the shift drum with the cut out in the engine case.

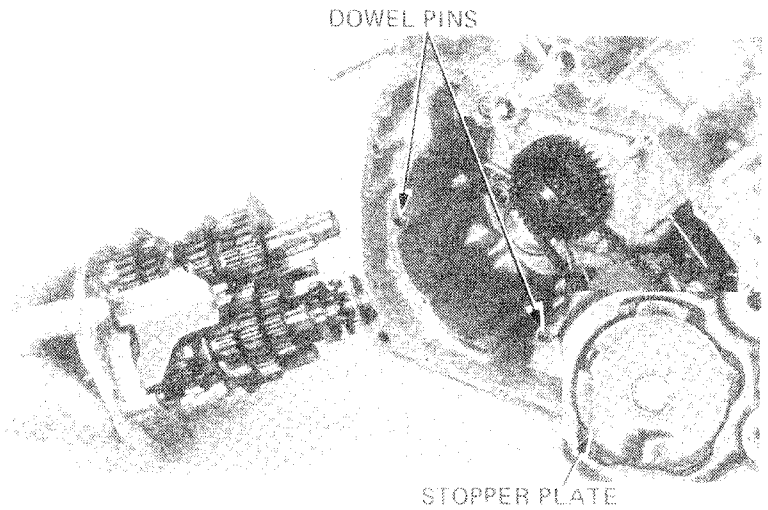

Press the transmission holder into place while rotating the mainshaft.
Torque the holder bolts.

TRANSMISSION HOLDER

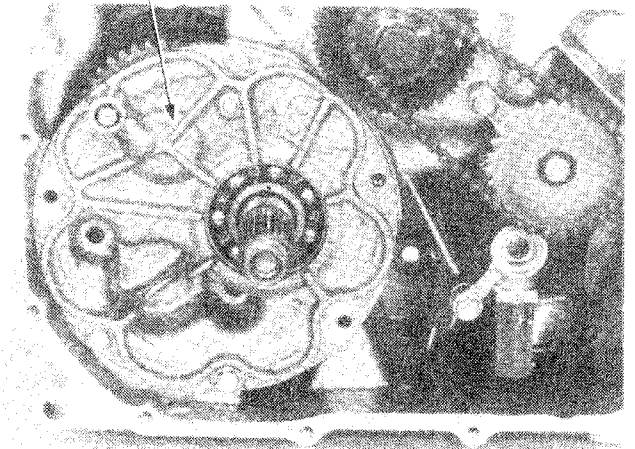

Install the oil separator.
Install the clutch (Page 7-6).
Install the engine front cover (Page 7-13).

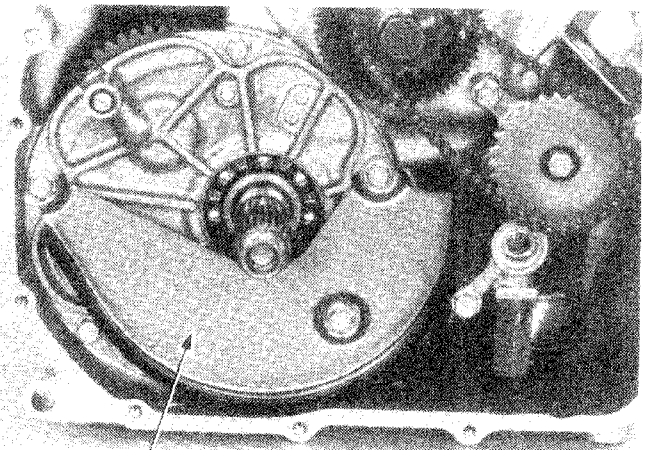

GEARSHIFT LINKAGE INSTALLATION

- Install the shift drum cam plate, pin, collar, center plate, and point plate.
- Install the gearshift arm.
- Install the spring on the shift arm and shift spindle.
- Install the spindle.
- Rotate the shift drum to neutral.
- Install the drum stopper cam plate.
- Apply a locking agent and tighten the 6 mm bolt.
- Attach the stopper spring hook onto the case.

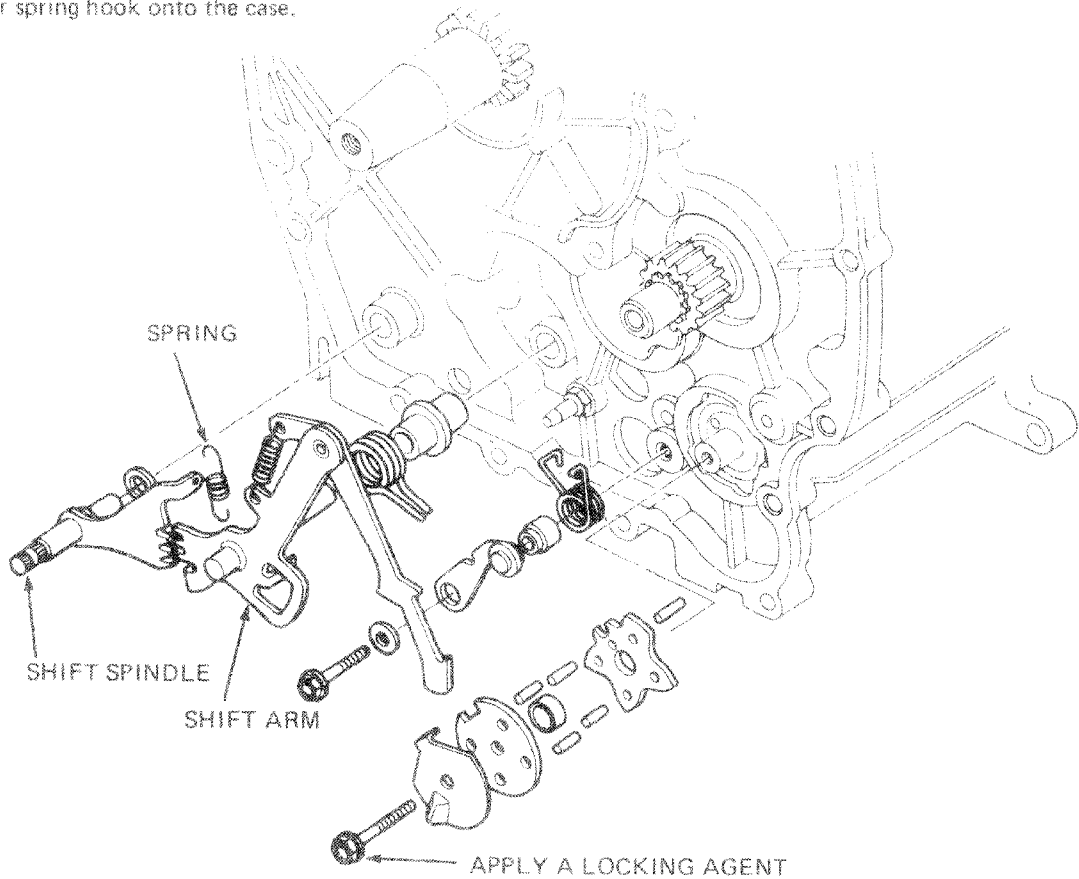

- Install the final shaft.
- Install the rear cover (See section 9).

NOTE

After installing the rear cover, install the gearshift pedal and check its operation.

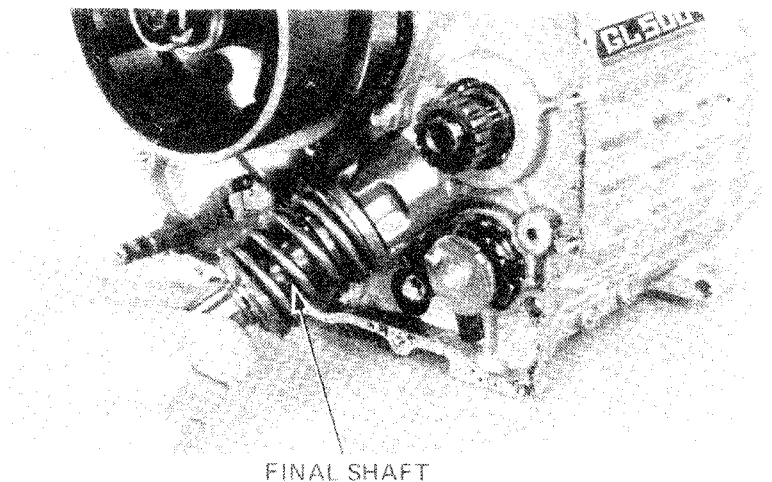



HONDA
GL500
GL500 INTERSTATE

MEMO

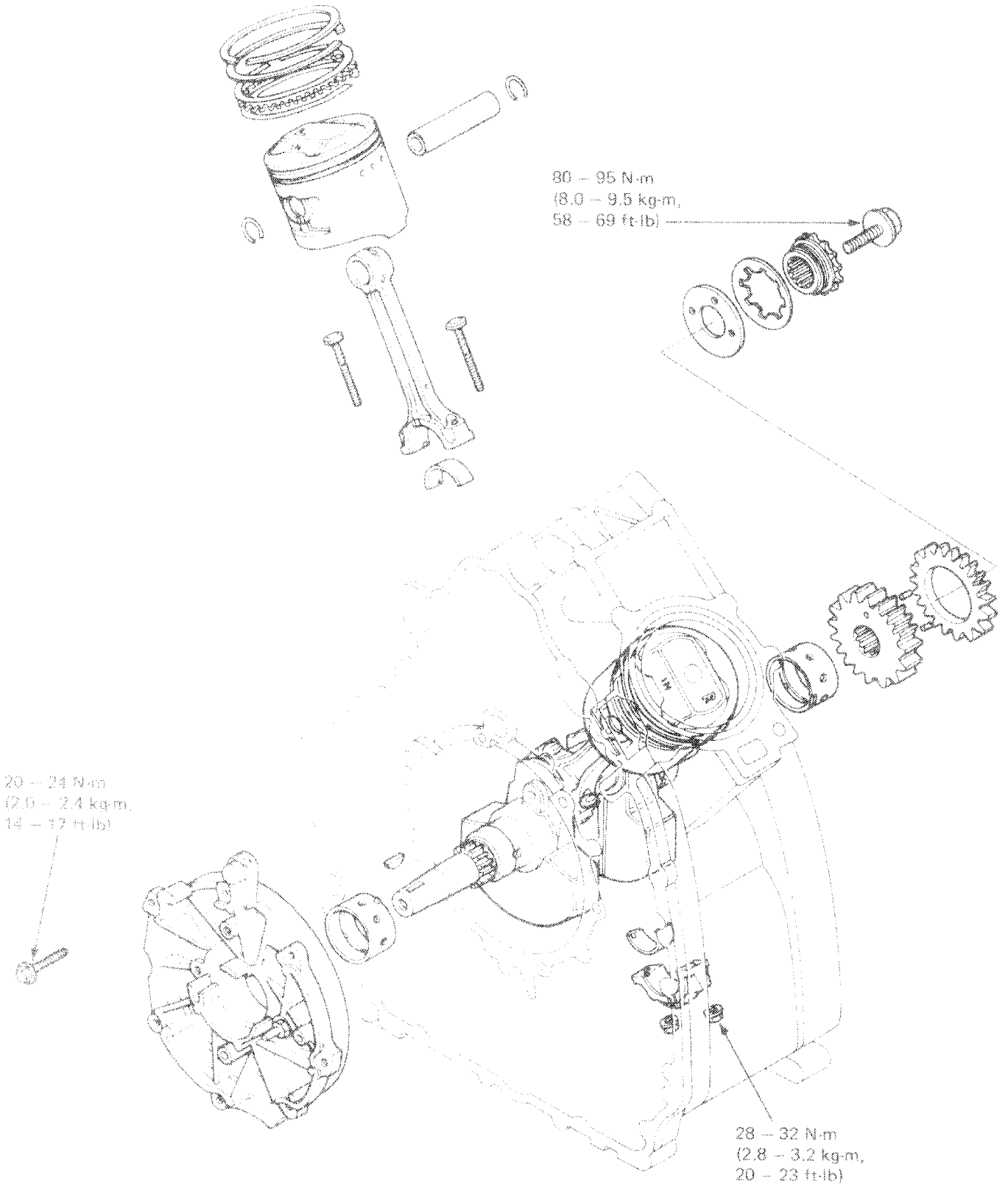



12. CRANKSHAFT/PISTON

SERVICE INFORMATION	12-1	BEARING INSPECTION/SELECTION	12-8
TROUBLESHOOTING	12-2	MAIN JOURNAL BEARING REPLACEMENT	12-11
CONNECTING ROD REMOVAL	12-3	CRANKSHAFT INSTALLATION	12-14
PISTON REMOVAL	12-4	PISTON INSTALLATION	12-16
CYLINDER INSPECTION	12-5	CONNECTING ROD INSTALLATION	12-17
CRANKSHAFT REMOVAL	12-6		

SERVICE INFORMATION

GENERAL INSTRUCTIONS

- All bearing inserts are a select fit and are identified by color codes. Select replacement bearing from the color code table.
- After installing new bearings, recheck them with plastigauge.
- Before removing the piston and connecting rod assemblies, clean the top of the cylinder of carbon deposits.
- The right piston can be serviced by removing the oil pump and transmission cover. To service the left piston, it is necessary to remove the transmission.
- Apply molybdenum disulfide grease to the journals, crankpins and bearings during assembly.

TOOLS

Special

Gear holder	07924-4150000
Piston remover	07941-4150000
Crank cap puller	07935-4150000
Crank cap driver	07945-4150100
Main bearing dis/assembly tool	07973-4150000

Common

Piston slider	07755-0010000 or commercially available in U.S.A.
---------------	---------------------------------------------------

SPECIFICATIONS

mm (in)

Item		Standard		Service Limit		
Crankshaft	Main journal oil clearance	0.020-0.060	(0.0008-0.0023)	0.085	(0.0033)	
	Crankpin oil clearance	0.020-0.044	(0.0008-0.0017)	0.080	(0.0031)	
	Connecting rod side clearance	0.150-0.170	(0.0059-0.0067)	0.350	(0.0138)	
Cylinder	I.D.	78.000-78.015	(3.0709-3.0715)	78.100	(3.0748)	
	Warpage	-		0.10	(0.004)	
Piston ring	Ring-to-groove clearance	Top	0.015-0.050	(0.0006-0.0020)	0.10	(0.004)
		Second	0.015-0.050	(0.0006-0.0020)	0.10	(0.004)
	Ring end gap	Top	0.10-0.25	(0.004-0.010)	0.60	(0.024)
		Second	0.10-0.25	(0.004-0.010)	0.60	(0.024)
	Oil (side rail)	0.20-0.40	(0.008-0.016)	1.0	(0.04)	
Piston/	Piston O.D.	77.940-77.960	(3.0685-3.0693)	77.860	(3.0653)	
Piston pin	Piston pin bore	21.002-21.008	(0.8268-0.8271)	21.040	(0.8283)	
	Piston pin O.D.	20.994-21.000	(0.8265-0.8268)	20.984	(0.8261)	
	Small end I.D.	21.020-21.041	(0.8276-0.8284)	21.068	(0.8294)	
	Piston-to-cylinder clearance	-		0.10	(0.004)	



CRANKSHAFT/PISTON

TORQUE VALUES

Crankshaft cap bolt	20--24 N·m (2.0--2.4 kg-m, 14--17 ft-lb)
Connecting rod cap nut	28--32 N·m (2.8--3.2 kg-m, 20--23 ft-lb)
Primary drive gear bolt	80--95 N·m (8.0--9.5 kg-m, 58--69 ft-lb)

TROUBLESHOOTING

Excessive Noise

1. Crankshaft
 - Worn main bearing
 - Worn rod bearing
2. Piston and Connecting Rod
 - Worn piston or cylinder
 - Worn piston pin or pin hole
 - Worn rod small end

Low Compression or Uneven Compression

1. Worn cylinder or piston ring

Excessive Smoke

1. Worn cylinder, piston or piston rings
2. Improperly installed piston rings
3. Damaged piston or cylinder

Overheating

1. Excessive carbon build-up on piston head
2. Blocked or restricted flow of coolant
3. Sticking thermostat

Knocking or Abnormal Noise

1. Worn pistons and cylinders
2. Excessive carbon build-up on piston head



CONNECTING ROD REMOVAL

Remove the cylinder head (Page 6-3).
Remove the oil pump (Page 7-9).
Remove the transmission (Page 11-4).
Scrape all deposits from the top of the cylinder.

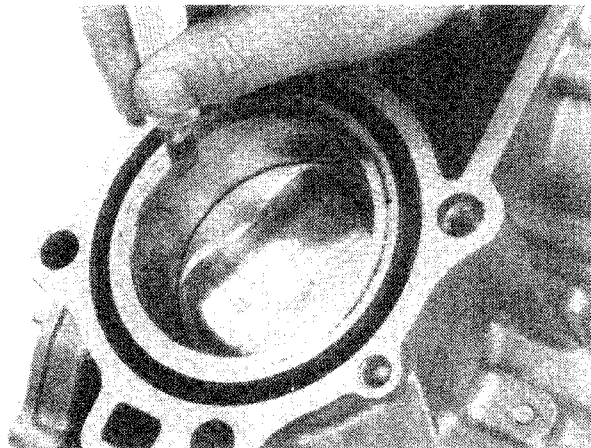

Turn the crankshaft so that the piston to be removed is at B.D.C. (Bottom Dead Center).
Remove the bearing cap.
Mark the bearing caps and rods to indicate cylinder position.
Remove the left side cap from the transmission side. Work through the hole on the oil pump side to remove the right side cap.

CONNECTING ROD BEARING CAP

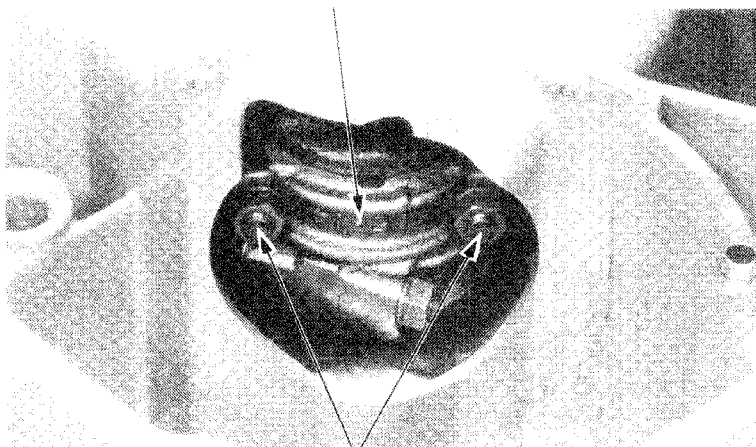

BEARING CAP NUTS

Turn the crankshaft so that the piston is at T.D.C.
Place the PISTON REMOVER over the rod bolts, and push the piston and rod assembly out.

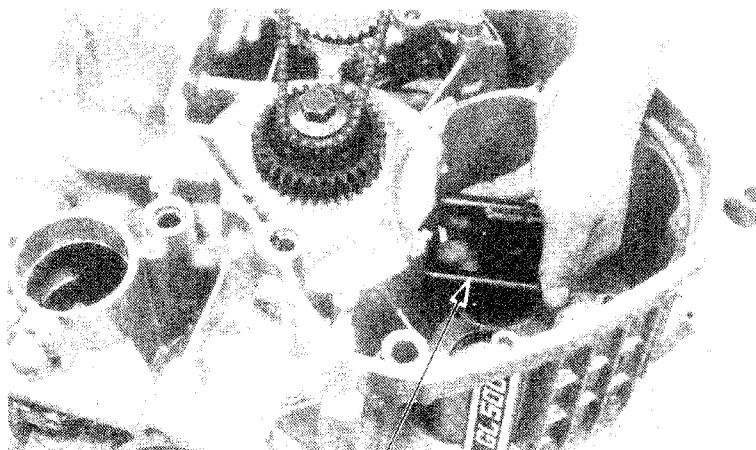

PISTON REMOVER



CRANKSHAFT/PISTON

PISTON REMOVAL

Remove the piston pin clips.
Remove the pin.

NOTE

Mark the pins to indicate the piston position.

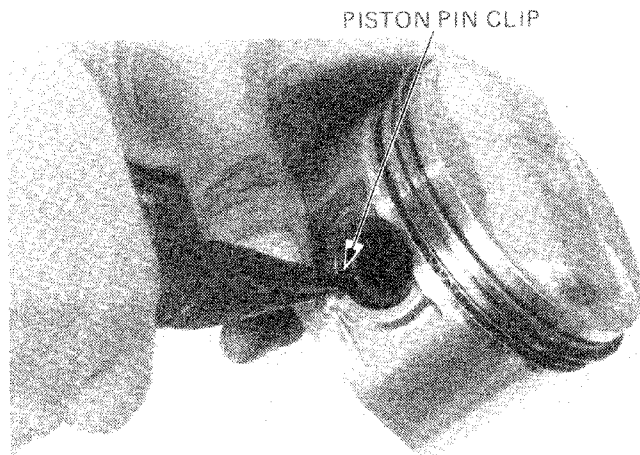

PISTON INSPECTION

Measure the ring-to-groove clearance.

SERVICE LIMIT:

(TOP/SECOND) : 0.10 mm (0.004 in)

Remove the piston rings.

NOTE

Mark the rings so they can be assembled in their original position.

Clean and inspect the piston crown.

Inspect the piston for damage and cracks; check the ring grooves for excessive wear.

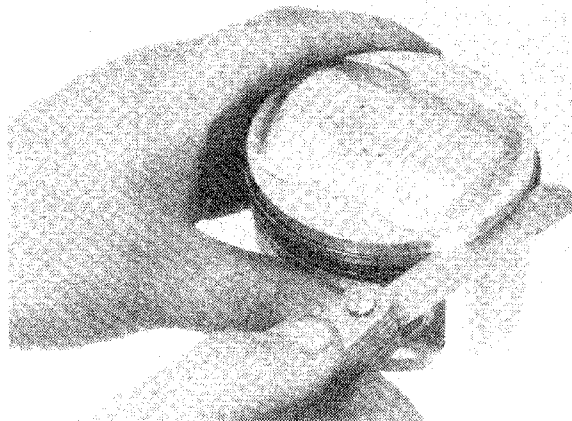

Insert each piston ring into the cylinder and measure the ring end gap.

SERVICE LIMIT:

TOP/SECOND : 0.60 mm (0.024 in)

OIL (SIDE RAIL) : 1.0 mm (0.04 in)

NOTE

To measure the gap, use a piston and push the ring squarely into the cylinder.

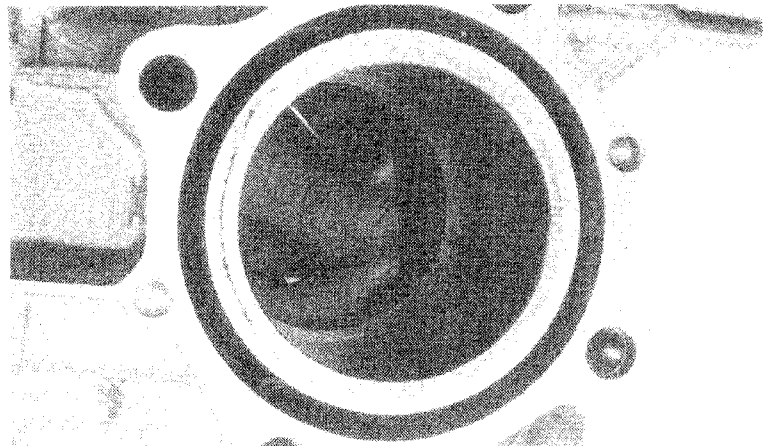



Measure each piston diameter at the skirt.
SERVICE LIMIT: 77.86 mm (3.0653 in)

If the pistons show wear beyond limits, replacement is necessary.

NOTE

Measure the piston diameter 7–10 mm (0.28–0.40 in) from the bottom of the piston, and 90° to the piston pin hole.

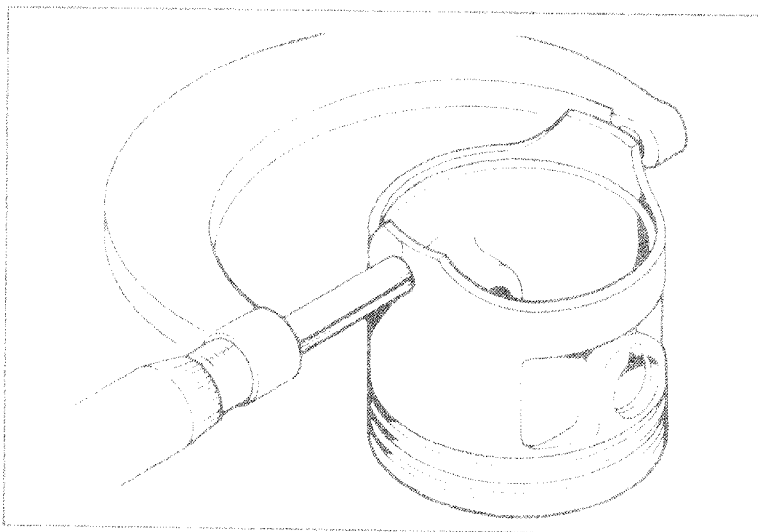

CYLINDER INSPECTION

Measure the cylinder I.D.
SERVICE LIMIT: 78.100 mm (3.0748 in)

Calculate the piston to cylinder clearance.
SERVICE LIMIT: 0.10 mm (0.004 in)

Oversize pistons are available in the following sizes:
0.25 and 0.50 mm.

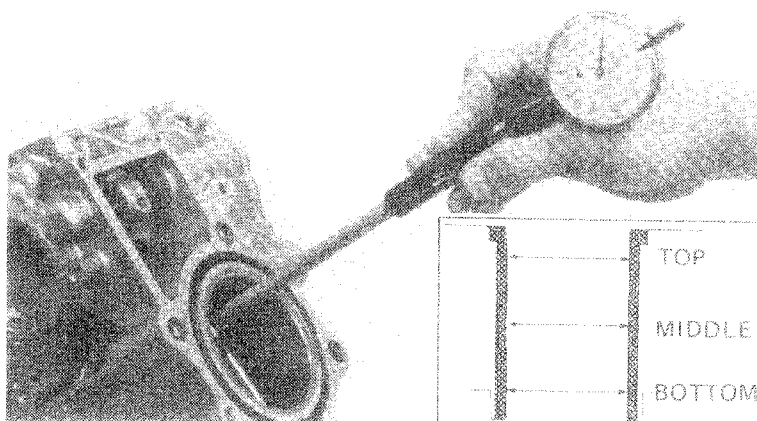

Measure each piston pin bore.
SERVICE LIMIT: 21.040 mm (0.8283 in)

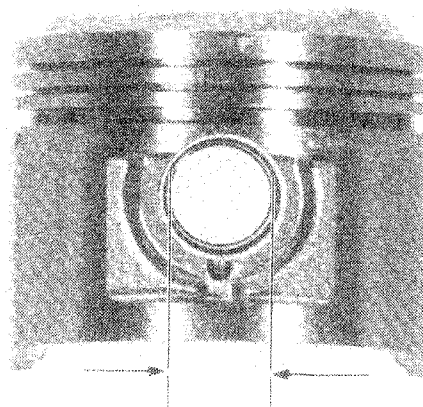



CRANKSHAFT/PISTON

Measure each piston pin O.D.

SERVICE LIMIT: 20.984 mm (0.8261 in)

Calculate the piston pin to piston clearance.

SERVICE LIMIT: 0.05 mm (0.002 in)

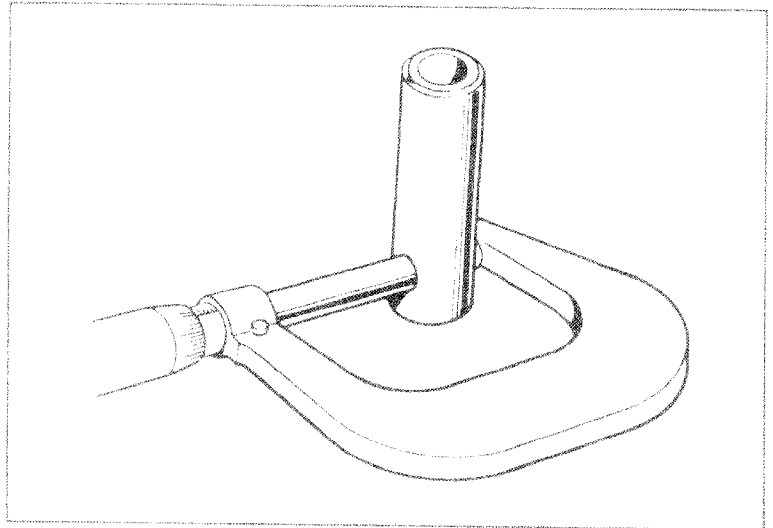

Measure the rod end I.D. If the reading exceeds the service limit, replace the rod.

SERVICE LIMIT: 21.068 mm (0.8294 in)

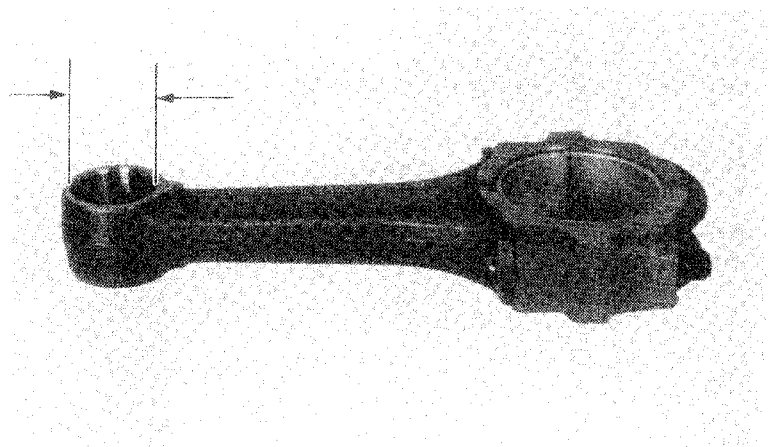

CRANKSHAFT REMOVAL

Hold the primary drive gear with a GEAR HOLDER. Remove the 12 mm bolt and the oil pump sprocket, disc spring, side plate, sub gear and primary gear.

NOTE

Mark the sub gear and side plate so that they will face the correct direction during re-assembly.

GEAR HOLDER 07924-4150000

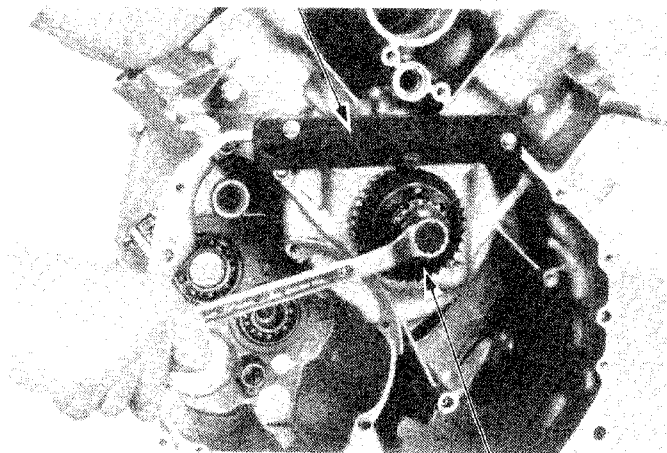

PRIMARY DRIVE GEAR



Remove the flywheel and cam chain (Page 10-2).
Remove the crankshaft cap bolts.

NOTE

Before removing the crankshaft, wrap the splines of the primary gear and timing sprocket with vinyl tape to prevent damage to them.

CRANKSHAFT CAP

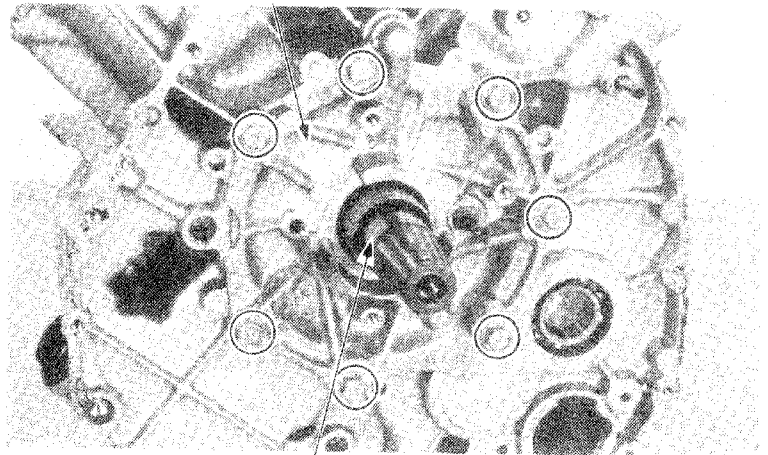

VINYL TAPE

Attach the CRANK CAP PULLER to the front of the engine.

Press the crankshaft out by screwing in the CRANK CAP PULLER, or use a press to remove the crankshaft.

WARNING

Do not damage the bearing when removing the crankshaft

CRANK CAP PULLER

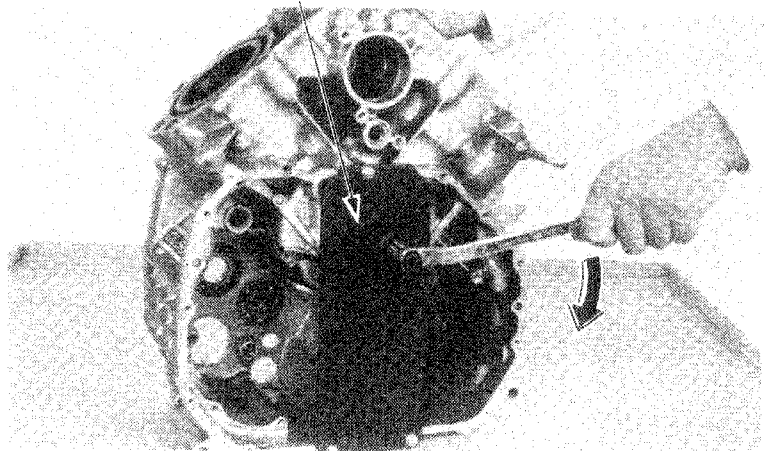

ROD SIDE CLEARANCE INSPECTION

Install each connecting rod and bearing cap in its original position and torque to specifications.

TORQUE: 28–32 N·m (2.8–3.2 kg·m,
20–23 ft·lb)

NOTE

- Torque the cap bolts evenly in 2–3 steps.
- Do not rotate the crankshaft during inspection.

Measure the rod side clearance with a feeler gauge.

SERVICE LIMIT: 0.35 mm (0.0138 in)

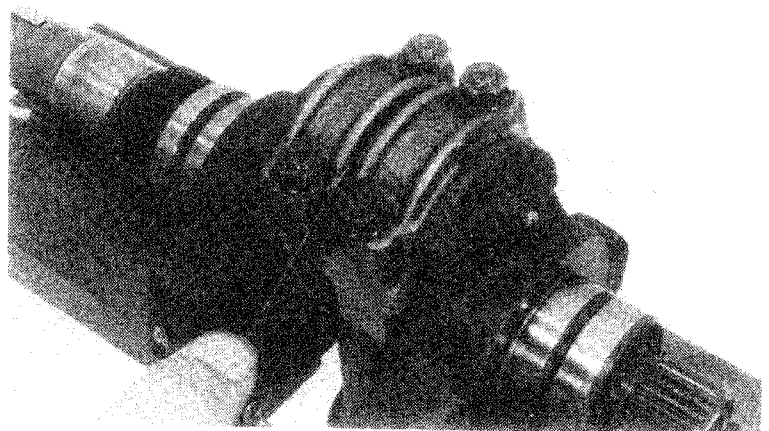

BEARING INSPECTION/SELECTION

CRANKPIN

Inspect each bearing insert for separation or other damage.

Put the connecting rod inserts in each rod cap. Place a plastigauge strip across each rod crankpin, avoiding the oil hole.

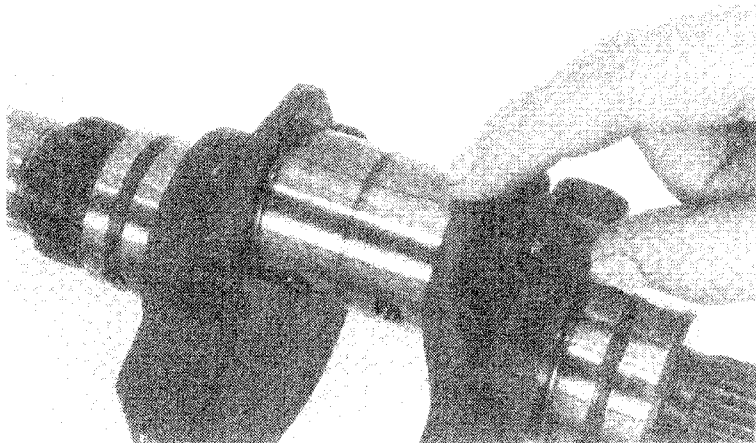

Install each connecting rod and bearing cap in their original positions and torque to specifications.

NOTE

- Torque the cap bolts evenly in 2-3 steps.
- Do not rotate the crankshaft during the inspection.

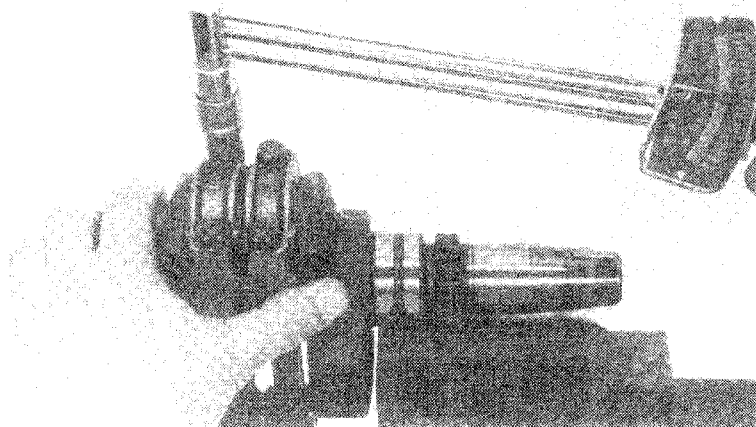

Remove the caps and measure the compressed plastigauge.

SERVICE LIMIT: 0.08 mm (0.003 in)

NOTE

The widest thickness determines the oil clearance.

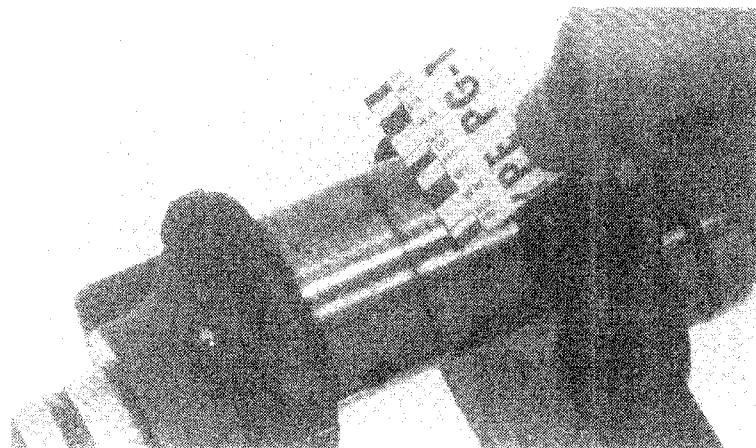



MAIN JOURNAL

Measure each journal O.D.

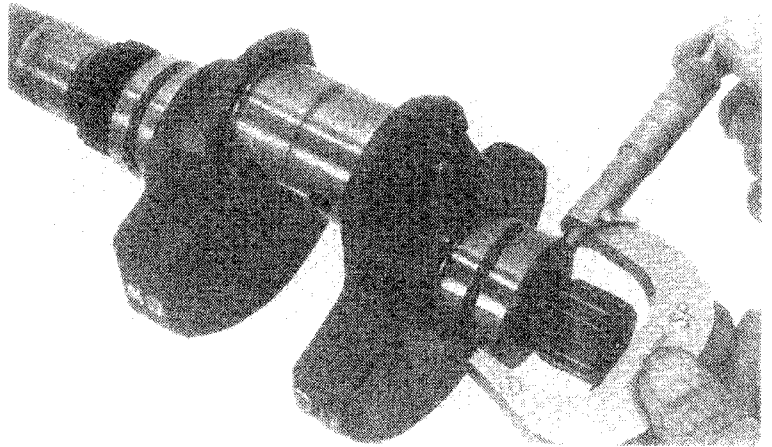

Measure the engine case and crankshaft bearing cap I.D.

Calculate the journal to bearing cap clearance.

SERVICE LIMIT: 0.085 mm (0.0033 in)

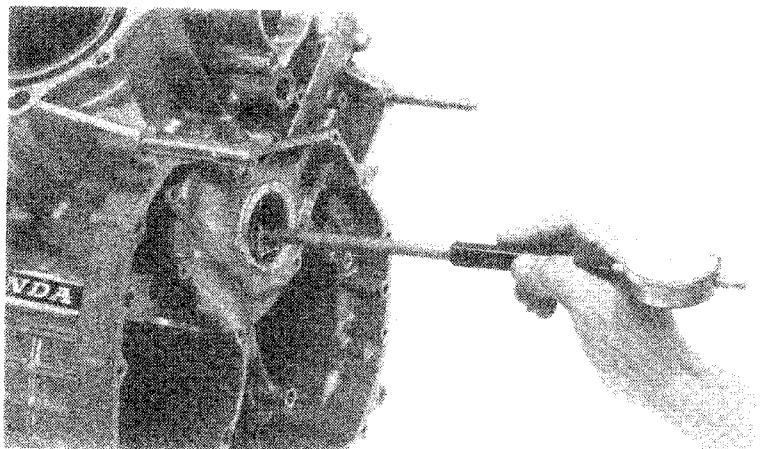

Measure the crankshaft bearing cap I.D.

Calculate the journal to bearing cap clearance.

If rod bearing clearance is beyond tolerance, select replacement bearings (Page 12-10).

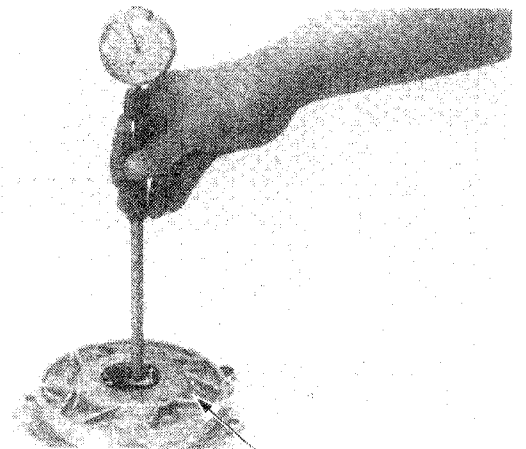

BEARING CAP



CRANKSHAFT/PISTON

ROD BEARING SELECTION

Determine and record each connecting rod I.D. code number.

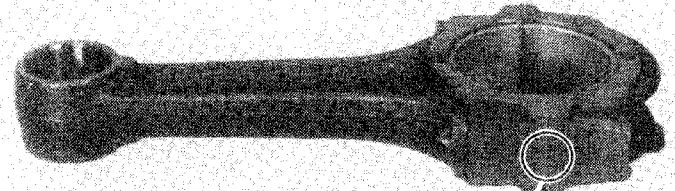

CODE NO.

Determine and record the corresponding crankpin O.D. code letters.

Cross reference the crank pin and rod codes to determine the replacement bearing color.

ROD BEARING SELECTION

CON- NECTING ROD I.D. CODE NUMBER	CRANKPIN SIZE CODE LETTER	A	B	C	
		39.992-- 40.000 mm (1.5745-- 1.5748 in)	39.984-- 39.992 mm (1.5742-- 1.5745 in)	39.976-- 39.984 mm (1.5739-- 1.5742 in)	COLOR IDENTIFICATION
1 43.000-- 43.008 mm (1.6929-- 1.6932 in)	PINK	YELLOW	GREEN		
2 43.008-- 43.016 mm (1.6932-- 1.6935 in)	YELLOW	GREEN	BROWN		
3 43.016-- 43.024 mm (1.6935-- 1.6939 in)	GREEN	BROWN	BLACK		

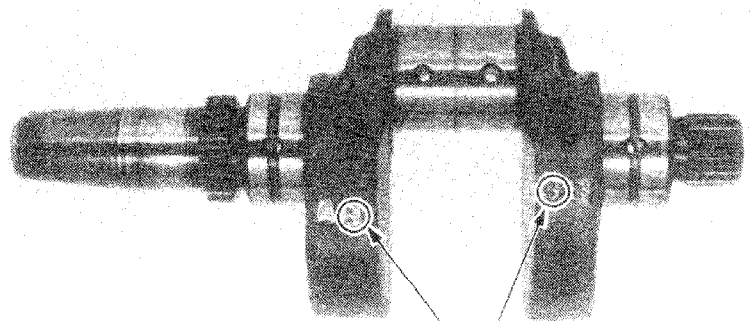

CRANKPIN O.D. CODE

ROD BEARING SIZES

COLOR	BEARING THICKNESS
BLACK	1.503 - 1.507 mm
BROWN	1.499 - 1.503 mm
GREEN	1.495 - 1.499 mm
YELLOW	1.491 - 1.495 mm
PINK	1.487 - 1.491 mm

NOTE

After fitting new bearing inserts, they should be rechecked with plastigauge.

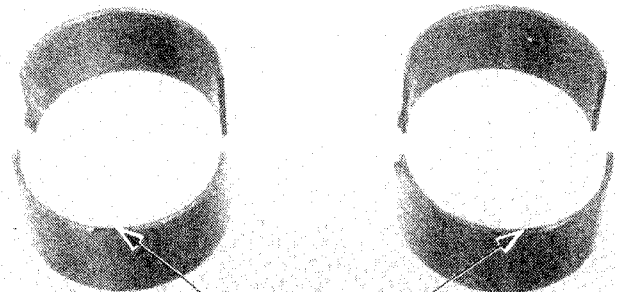

COLOR CODE



MAIN JOURNAL BEARING REPLACEMENT REMOVAL

Press the bearing out with a hydraulic press and bearing DIS/ASSEMBLY tool.

CAUTION

To prevent engine case damage, always use a hydraulic press and bearing removal tool to remove bearings.

MAIN BEARING DIS/ASSEMBLY TOOL
07973-4150000

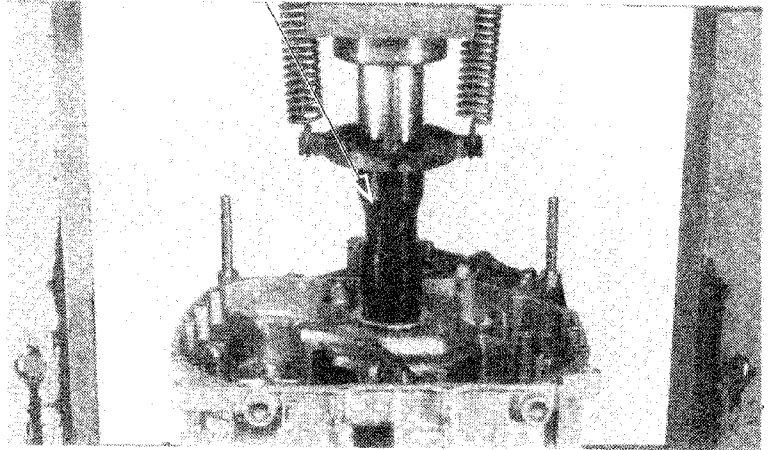

TOOL
07973-4150000
(Stamped "R")

ATTACHMENT:
(Part of 07973-4150000) (Stamped "P")
TO PRESS CRANK CAP BEARINGS

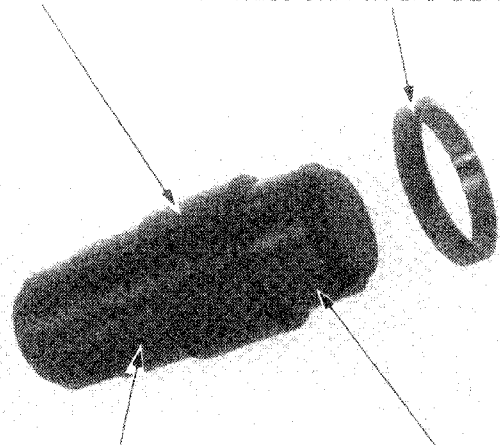

TO REMOVE CRANK CAP
AND CRANKCASE BEARING

TO PRESS MAIN
JOURNAL BEARINGS

Press the bearings out of the crankshaft cap bearing support with a hydraulic press and bearing removal tool.

CAUTION

To prevent crankshaft cap damage, always use a hydraulic press and bearing removal tool to remove bearings.

MAIN BEARING DIS/ASSEMBLY TOOL
07973-4150000

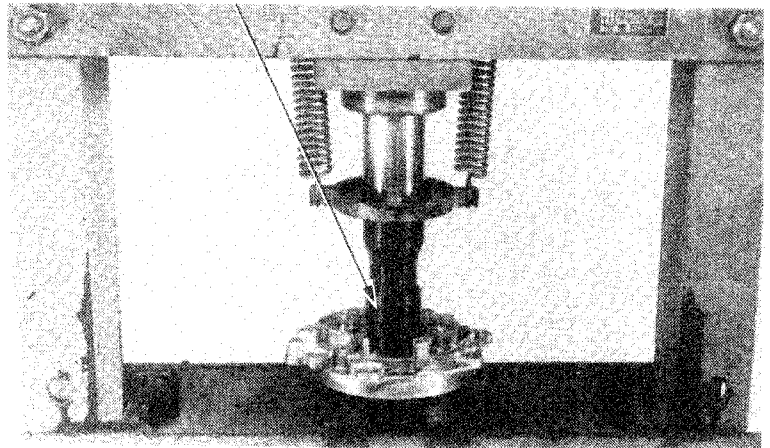

SELECTION

Determine and record the main journal O.D. codes.

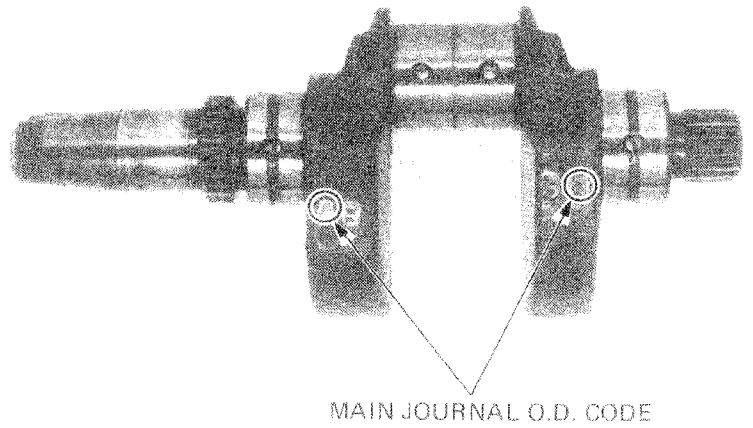

Measure the engine case bearing support I.D.

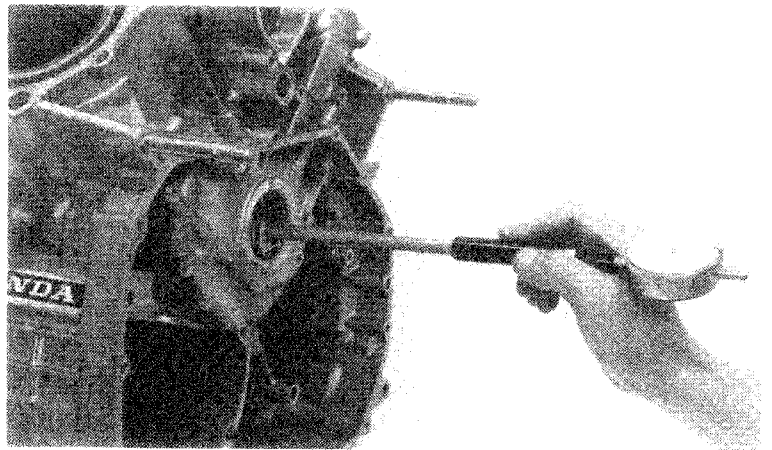

Measure the crankshaft cap bearing support I.D.

Cross reference the bearing support I.D. and crank journal codes to determine the replacement bearing color. (page 12-12).

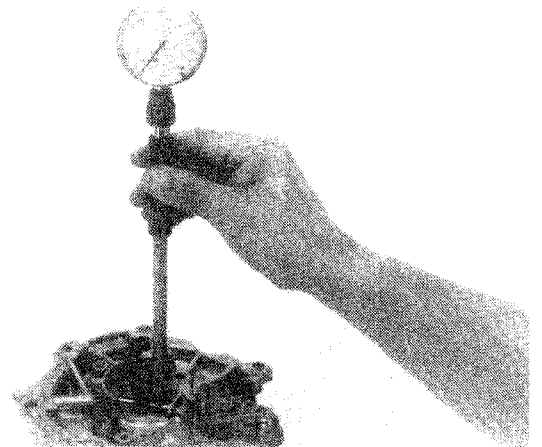

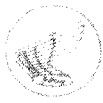

MAIN BEARING SELECTION

	MAIN JOURNAL SIZE CODES	
	A	B
CRANKCASE/CAP BEARING SUPPORT I.D.	BEARING IDENTIFICATION COLOR	
47.000-47.010 mm (1.8504-1.8508 in)	BROWN	BLACK
47.010-47.020 mm (1.8508-1.8517 in)	BLACK	BLUE

JOURNAL BEARING SIZES

COLOR	THICKNESS
BROWN	1.989-1.999 mm (0.0783-0.0787 in)
BLACK	1.994-2.004 mm (0.0785-0.0789 in)
BLUE	1.999-2.009 mm (0.0787-0.0791 in)

INSTALLATION

Apply engine oil or molybdenum disulfide grease to the bearing outer surface.

Align the tab of bearing insert with the holder cap groove and press the bearing into place. Use the end of the tool with the "P" mark.

NOTE

Draw two lines on the outside of the bearings to match the tab to aid in bearing alignment.

CAUTION

Be careful not to damage the bearing when press fitting them.

COLOR CODE

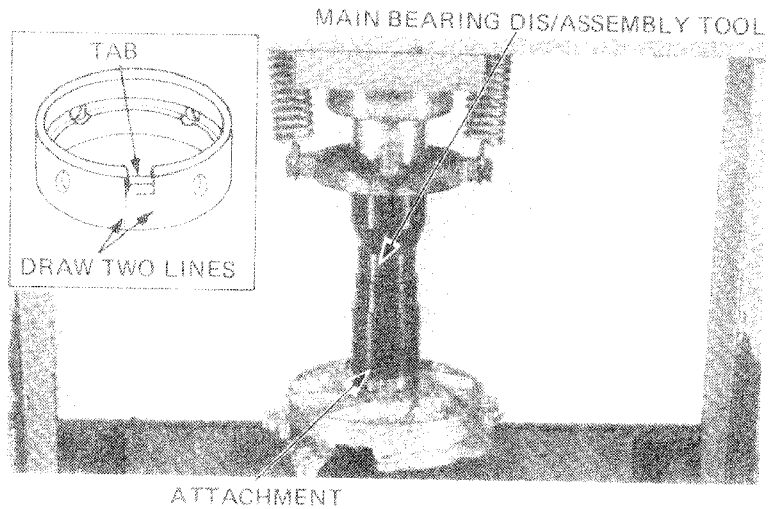
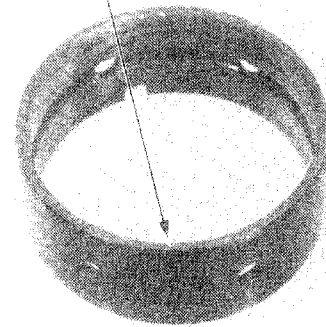

ALIGN

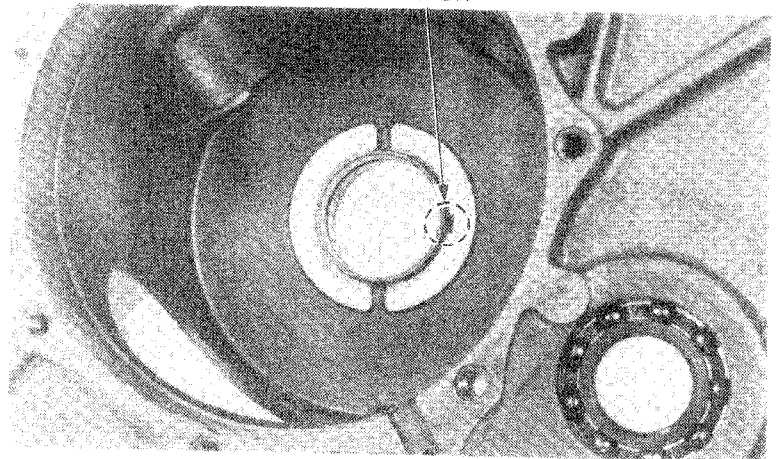

Lubricate the outer surface of each bearing with engine oil or molybdenum disulfide grease. Align the tab of bearing insert with the crankcase bearing support groove.

NOTE

Draw two lines on the outside of the bearings to match the tab to aid in bearing alignment.



CRANKSHAFT/PISTON

Press the bearing into engine case. Use the end of the tool with "P" mark.

CAUTION

Be careful not to damage the bearing when press fitting them.

MAIN BEARING DIS/ASSEMBLY TOOL

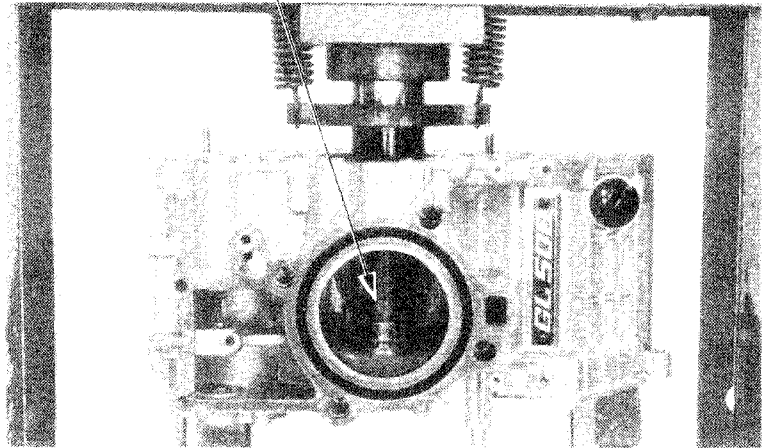

CRANKSHAFT INSTALLATION

Install the lower main bearing inserts.
Install the crankshaft.

NOTE

- Lubricate the bearings, main journals and crankpins with molybdenum disulfide grease.
- Wrap the splines of the crankshaft and timing gear area with vinyl tape to prevent damage.

CRANKSHAFT

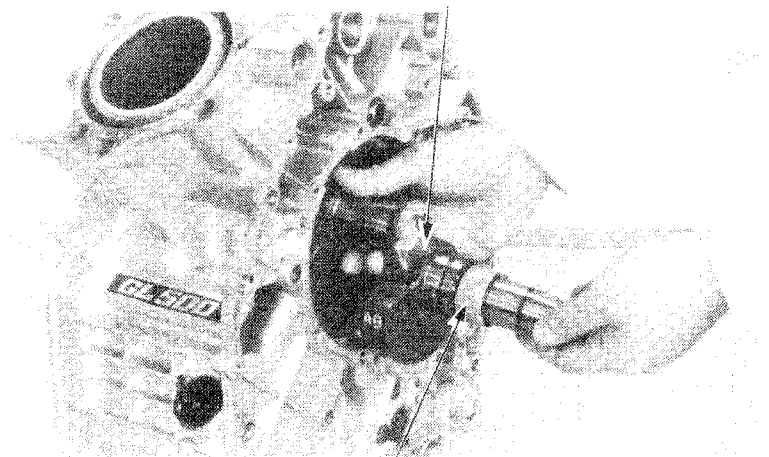

VINYL TAPE

Install the O-ring and collar.
Install the crankshaft holder cap.
Install the guide bolts in the crankshaft holder cap as shown.

NOTE

- Lubricate the bearing with molybdenum disulfide grease.
- Screw in the guide bolts so that the cap is not tilted.

O-RING AND COLLAR

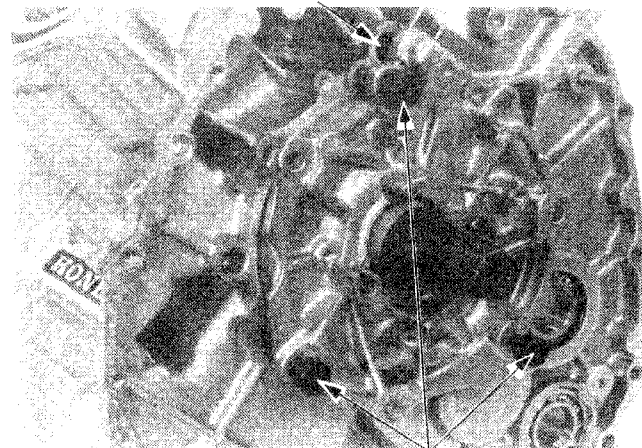

GUIDE BOLT



Drive the crankshaft holder cap into place with a hammer and driver.

CRANK CAP DRIVER 07945-4150100

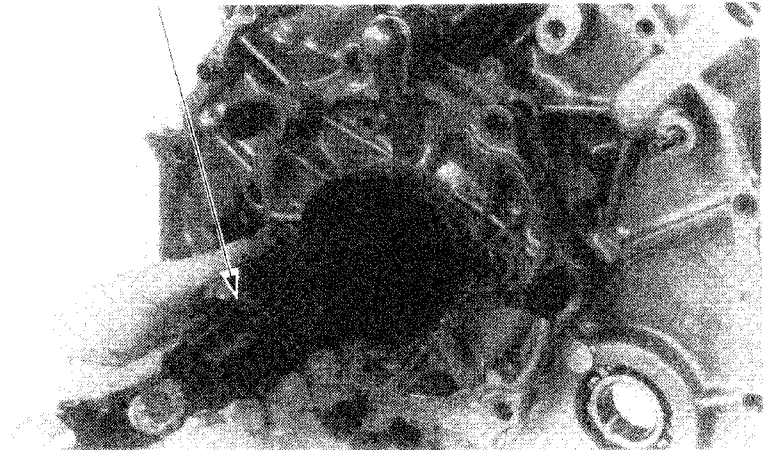

Tighten the cap bolts.

**TORQUE: 20–24 N·m (2.0–2.4 kg·m,
14–17 ft·lb)**

NOTE

After tightening the bolts, make sure that the crankshaft rotates freely.

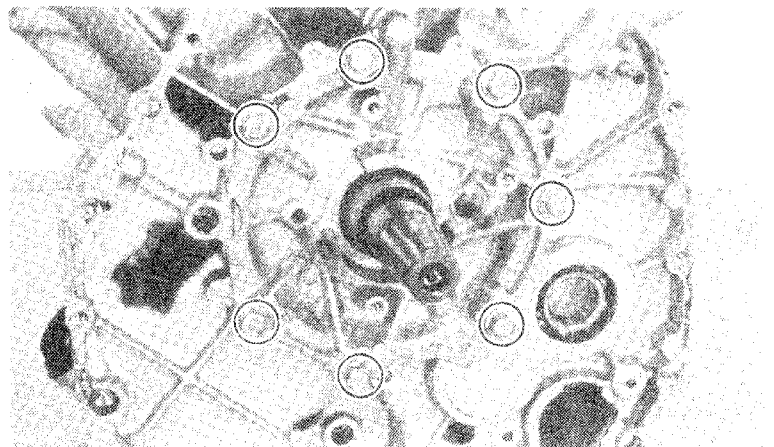

Install the primary gear, primary sub gear, side plate, disc spring and oil pump drive sprocket.

NOTE

- Install the disc spring with the pawls placed over the dowel pins to prevent them from coming out during operation.
- Before assembling, lubricate all parts with engine oil.
- Note the primary sub gear and side plate directions by referring to the marks made during disassembly.

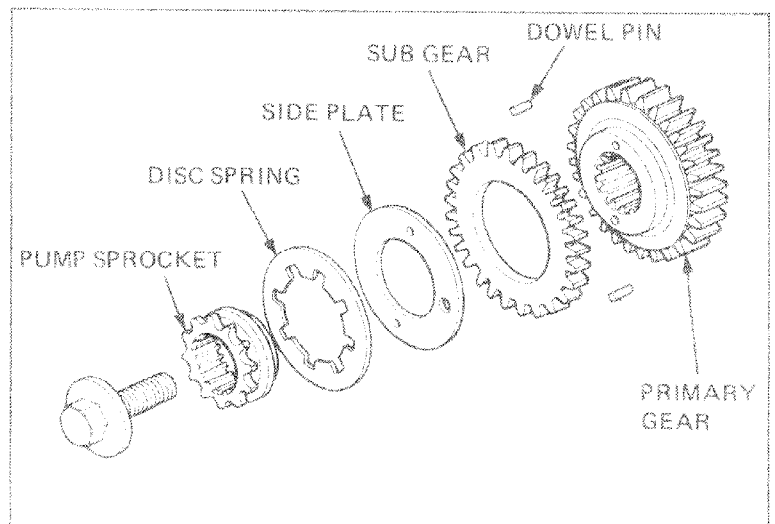

Install the DRIVE GEAR HOLDER to prevent the drive gear from turning.

Torque the primary gear.

TORQUE: 80–95 N·m (8.0–9.5 kg·m,
58–69 ft·lb)

DRIVE GEAR HOLDER 07924-4150000

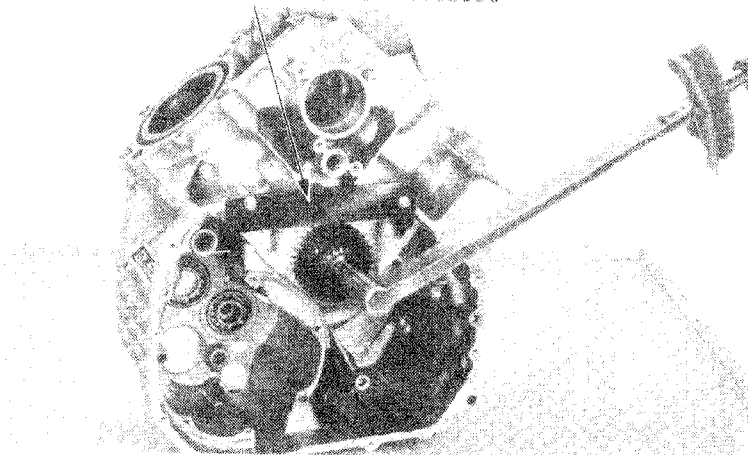

PISTON INSTALLATION

Clean the piston domes, ring lands, and side faces. Carefully install the piston rings.

NOTE

- Do not damage the pistons and piston rings during assembly.
- All rings should be installed with the markings facing up.
- Space the piston ring end gaps 120 degrees apart, avoiding the piston pin and thrust sides.
- Do not align the gaps in the oil rings.
- After installing the rings they should be free to rotate.

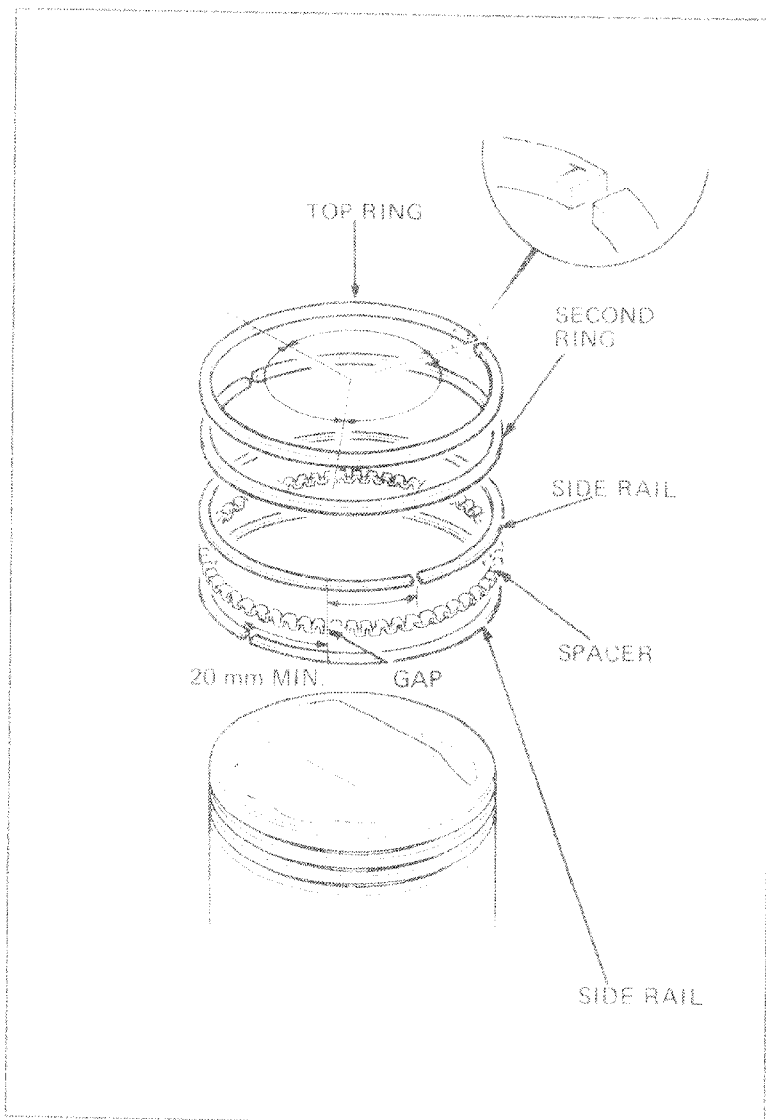



Coat the rod small end with molybdenum disulfide grease.
Assemble the pistons and connecting rods with the piston pins and new piston pin clips.

NOTE

- Do not interchange the pistons, piston pins and connecting rods.
- Make sure that the piston pin clips are properly seated.
- Install the piston with the "L" mark on the left and the piston with the "R" mark on the right.

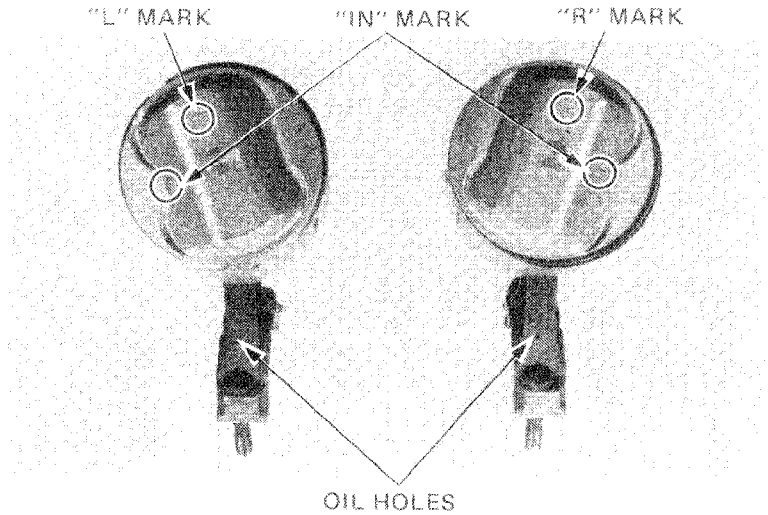

CONNECTING ROD INSTALLATION

Lubricate the rod bearings with molybdenum disulfide grease.

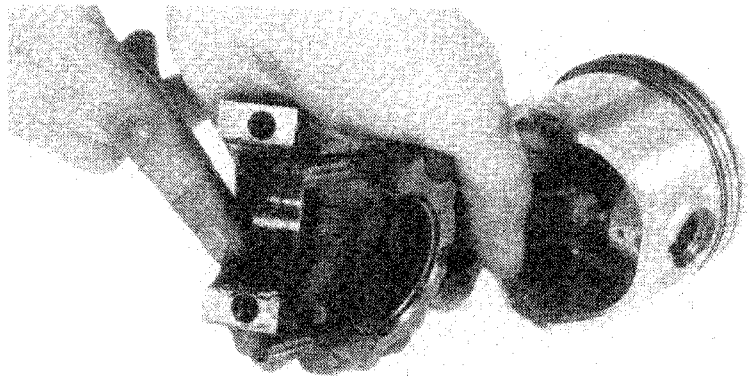

Install the rod assemblies into the cylinders from the top of the engine case.

NOTE

- The rod assemblies should be installed with the piston "IN" markings to the rear.
- Lubricate the piston ring grooves and cylinder walls with engine oil.

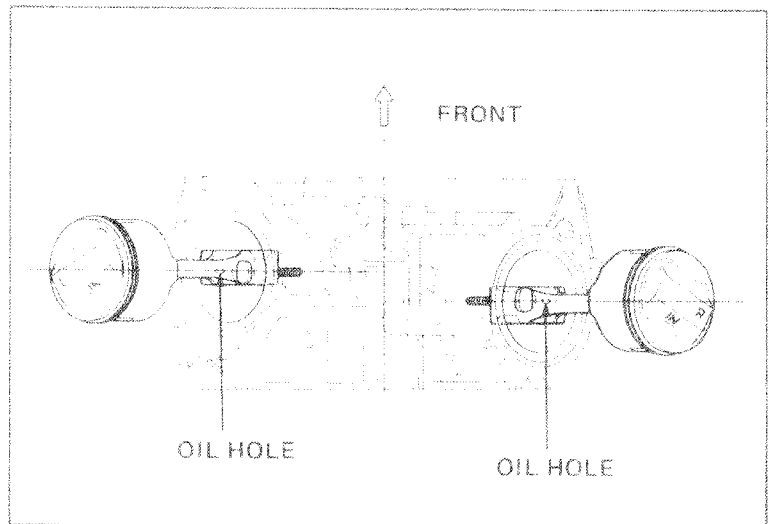



CRANKSHAFT/PISTON

Bring the piston to T.D.C.
Compress the piston rings with the PISTON SLIDER and insert the piston into the cylinder.

NOTE

- Do not damage the pistons or rings during assembly.
- Insert the piston into the cylinder, aligning the big end with the crankpin.

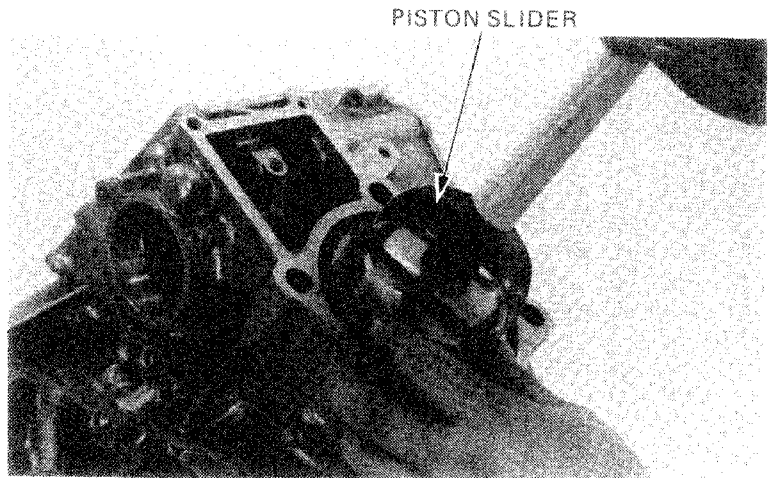

Install the connecting rod caps.
Torque the connecting rod cap bolts.
**TORQUE: 28–32 N·m (2.8–3.2 kg·m,
20–23 ft·lb)**

NOTE

- Be sure the bearing caps are installed in their correct location.
- Turn the crankshaft to make sure the rods rotate freely without binding.
- Torque the bolts evenly in 2–3 steps.

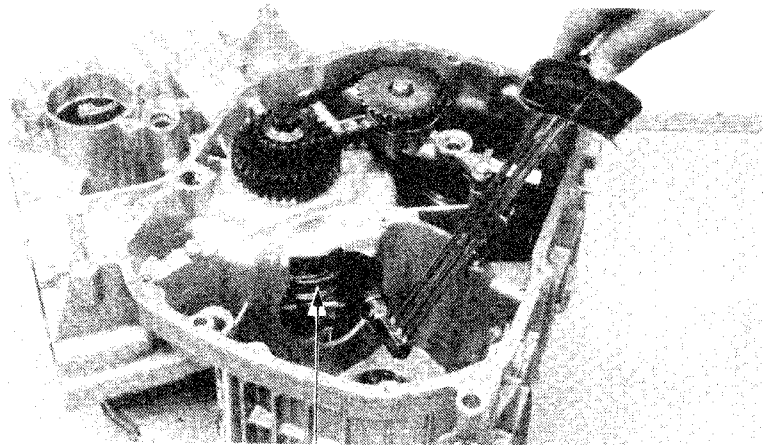

CONNECTING ROD BEARING CAP



HONDA
GL500
GL500 INTERSTATE

MEMO



FRONT WHEEL/SUSPENSION

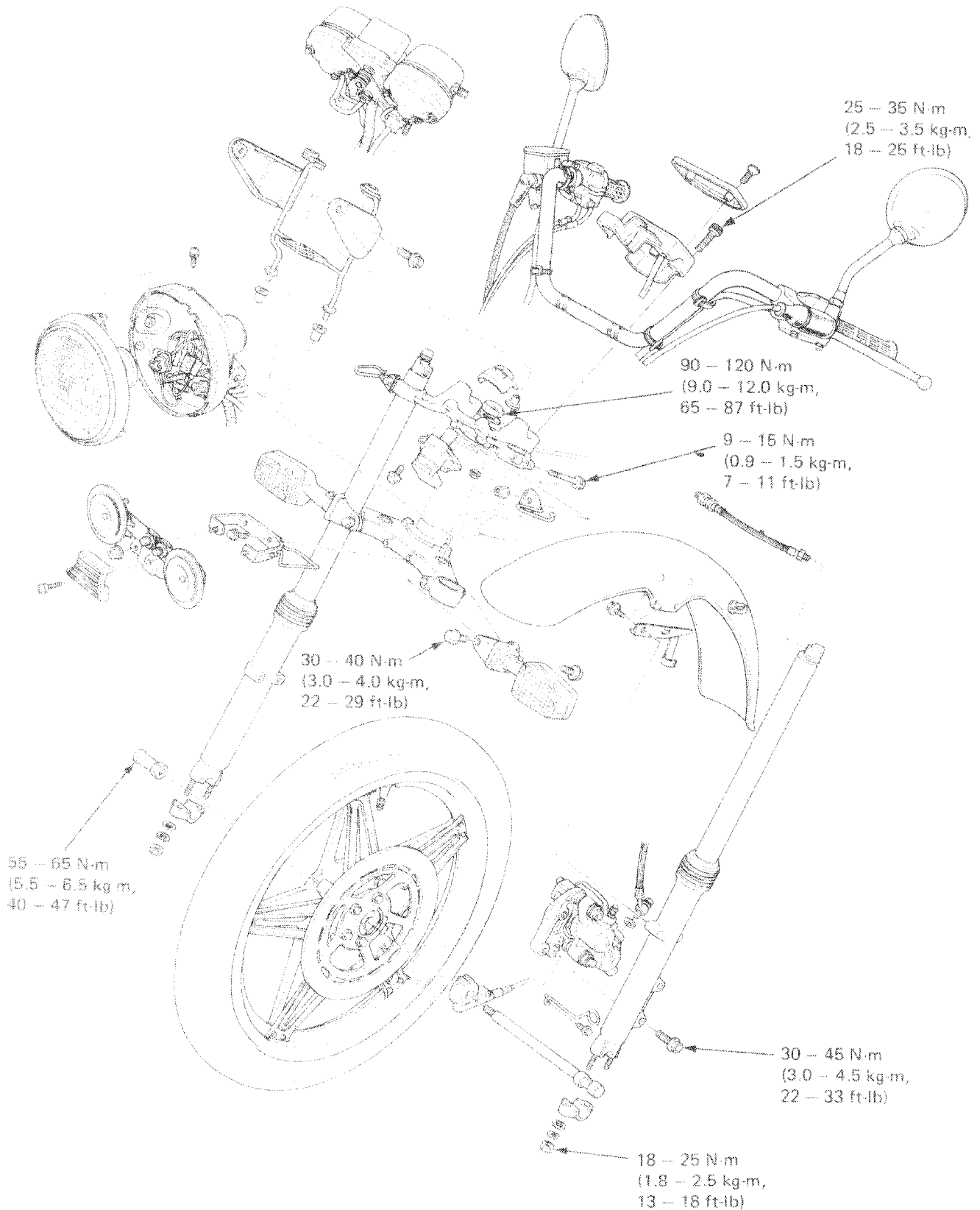

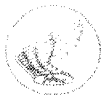

13. FRONT WHEEL / SUSPENSION

SERVICE INFORMATION	13-1	HANDLEBAR	13-4
TROUBLESHOOTING	13-2	FRONT WHEEL	13-6
HEADLIGHT	13-3	FRONT FORK	13-12
INSTRUMENTS	13-4	STEERING STEM	13-21

SERVICE INFORMATION

GENERAL INSTRUCTIONS

- * A jack or other support is required to support the motorcycle.
- * COMSTAR[®] wheels are not serviceable. If either the spokes, rim or hub are damaged the entire wheel must be replaced.
- * Never ride on the spokes.
- * Tubeless tire removal, repair and remounting procedures are covered in the Tubeless Tire Manual.
- * Check the fork tube bushing, slider bushing and back-up ring for damage after disassembling the front fork and replace if necessary.

TOOLS

Special

Circulip pliers	07914-3230001
Hex. wrench 6 mm	07917-3230000
Fork oil seal driver attachment	07947-KA20200
Ball race remover	07946-3710400
or	
Ball race remover	07953-KA50000
Ball race driver attachment (upper)	07946-3290000
Ball race driver attachment (lower)	07945-3330300
Steering stem driver	07946-3710601,
	or
	07946-3710400

Common

Bearing retainer wrench B	07710-0010200
Bearing retainer wrench body	07710-0010401
Fork oil seal driver body	07747-0010100
Pin spanner	07702-0010000
	M9361-412-
	099788 (U.S.A)
Socket wrench 30 x 32 mm	07716-0020400
Extension	07716-0020500
Bearing driver attachment 42 x 47 mm	07746-0010300
Bearing driver pilot 15 mm	07746-0040300
Bearing driver handle A	07749-0010000

SPECIFICATIONS

Unit : mm (in)

Item	Standard	Service Limit
Axle shaft runout	—	0.20 (0.008)
Front wheel rim runout	Radial	2.0 (0.08)
	Axial	2.0 (0.08)
Front cushion spring free length	Upper	100.7 (3.96)
	Lower	508.1 (20.00)
Front fork tube runout	—	0.20 (0.008)
Front fork oil capacity	210 cc (7.1 oz)	—
Fork air pressure	80-120 kPa (0.8-1.2 kg/cm ² , 11-17psi)	—

TORQUE VALUES

Handlebar holder bolt	25-35 N·m (2.5-3.5 kg-m, 18-25 ft-lb)
Fork bridge pinch bolt	9-15 N·m (0.9-1.5 kg-m, 7-11 ft-lb)
Steering stem pinch bolt	30-40 N·m (3.0-4.0 kg-m, 22-29 ft-lb)
Front axle nut	55-65 N·m (5.5-6.5 kg-m, 40-47 ft-lb)
Steering stem nut	90-120 N·m (9.0-12.0 kg-m, 65-87 ft-lb)
Front axle holder nut	18-25 N·m (1.8-2.5 kg-m, 13-18 ft-lb)
Caliper mount bolt	30-45 N·m (3.0-4.5 kg-m, 22-33 ft-lb)
Caliper bolt	20-25 N·m (2.0-2.5 kg-m, 14-18 ft-lb)
Caliper pivot bolt	25-30 N·m (2.5-3.0 kg-m, 18-22 ft-lb)



TROUBLESHOOTING

Hard Steering

1. Steering stem nut too tight
2. Faulty steering stem bearings
3. Damaged steering stem ball race and/or cone race
4. Insufficient tire pressure

Steers to One Side or Does Not Track Straight

1. Bent forks
2. Bent frame
3. Forks installed incorrectly
4. Axle installed incorrectly
5. Bent swingarm
6. Wheel installed incorrectly

Front Wheel Wobbling or Vibration

1. Loose axle (front or rear)
2. Loose wheel bearings
3. Loose steering stem nut or bearings
4. Loose lock nut(s) on swingarm pivot bolt
5. Unbalanced tire and wheel
6. Bent wheel
7. Excessive lateral runout in wheel
8. Bent forks
9. Bent swingarm
10. Bent or cracked frame
11. Loose engine mounts

Soft Suspension

1. Weak fork spring
2. Insufficient fluid in front forks
3. Insufficient fork air pressure

Hard Suspension

1. Incorrect fluid weight in front forks
2. Clogged fork hydraulic passage
3. Bent fork tubes
4. Slider binding
5. Too much air pressure

Front Suspension Noise

1. Slider binding
2. Insufficient fluid in forks
3. Loose front fork fasteners
4. Steering stem nut loose
5. Broken parts in forks



HEADLIGHT

HEADLIGHT CASE REMOVAL

Remove the headlight.
Disconnect all wires at their couplers and connectors.
Unscrew the headlight case mounts and remove the case.

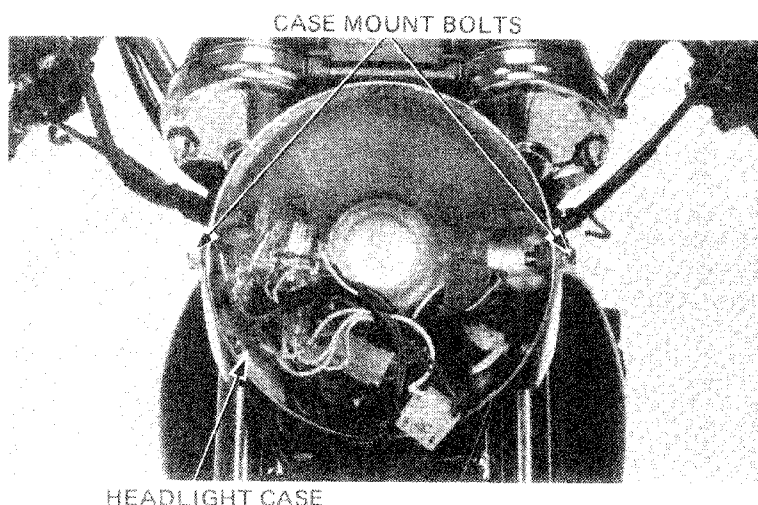

HEADLIGHT DISASSEMBLY/ASSEMBLY

Remove the retaining screws and horizontal adjusting screw from the rim.
Remove the two headlight unit retaining screws, and headlight unit.
Assembly is the reverse of disassembly.

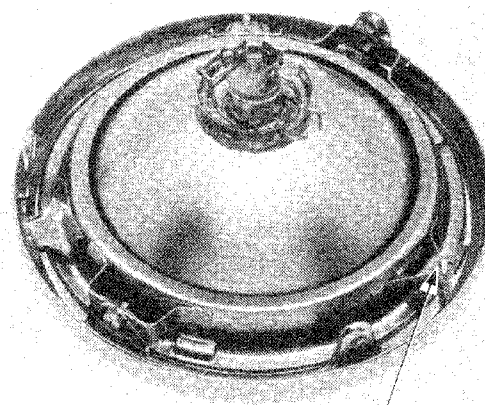

HEADLIGHT CASE INSTALLATION

Align the punch marks on the headlight case and bracket.
Connect all wires at their couplers and connectors.

NOTE

Check each component for operation after assembling.

Connect the headlight coupler.
Align the headlight thread holes with the headlight case holes.
Secure the headlight with three screws.
Adjust the headlight aim after assembly (Page 3-13)

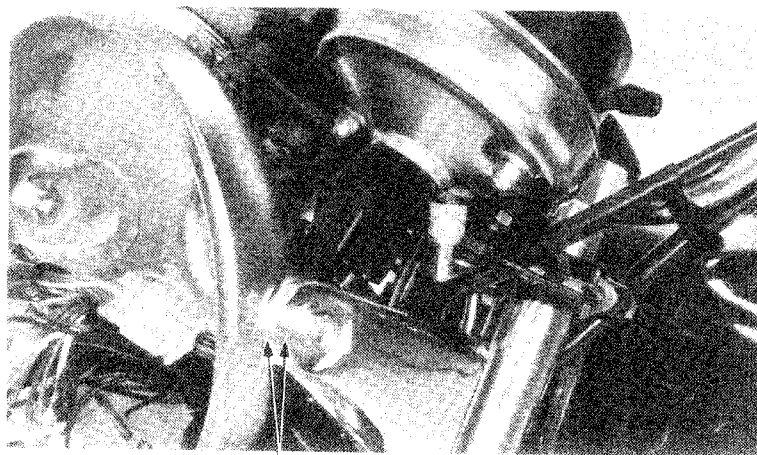



INSTRUMENTS

REMOVAL

Remove the headlight case.

Disconnect the instrument wire connectors and coupler.

Remove the speedometer and tachometer cables from the instruments.

Remove the instrument mounting nuts and the instruments.

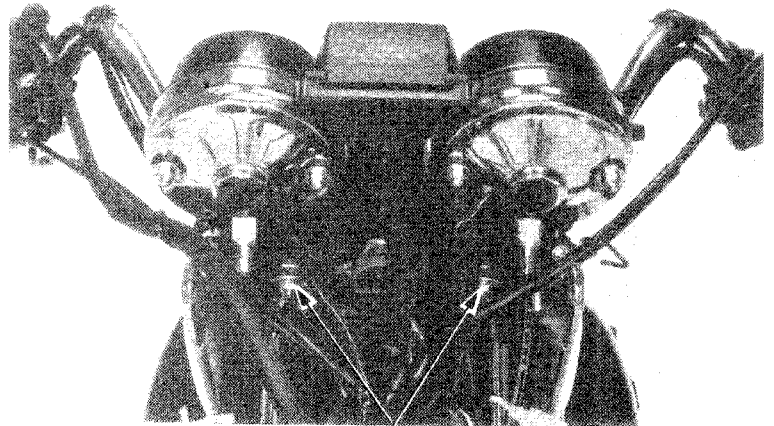

INSTRUMENT MOUNTING NUTS

DISASSEMBLY

Remove the meter mounting nuts and meter from the mounting bracket.

Remove the cap nuts and meter cover.

Remove the two screws and indicator socket.

Install the removed parts in the reverse order of disassembly.

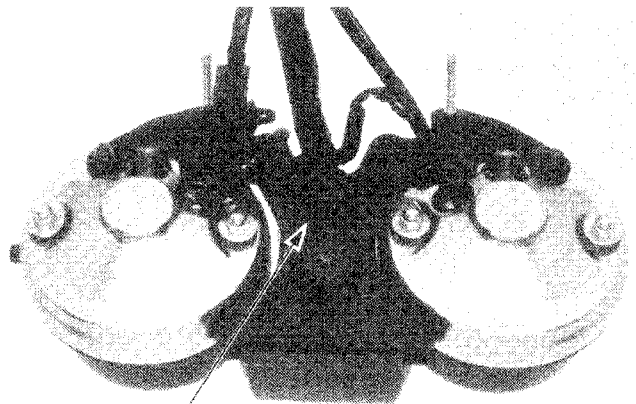

MOUNTING BRACKET

HANDLEBAR

REMOVAL

Disconnect the front brake stoplight switch wires and remove the master cylinder.

NOTE

Do not loosen the brake hose unless necessary.

WARNING

- After removing the master cylinder, keep it level. Do not tilt the master cylinder, or turn it upside down.
- Do not hang the master cylinder by the brake hose.

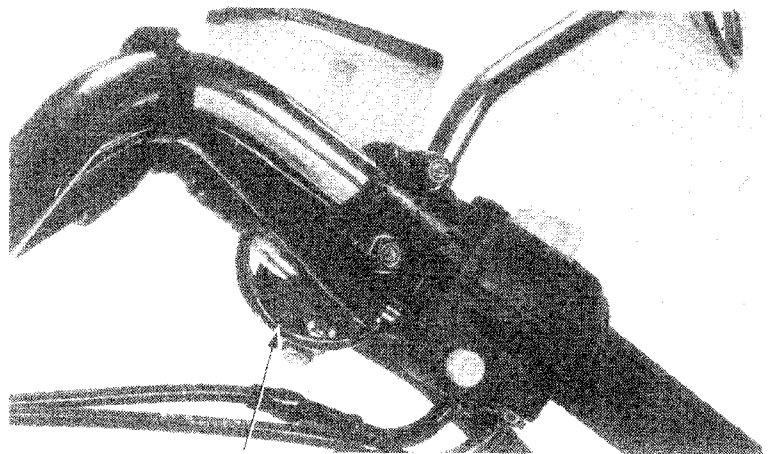

STOPLIGHT SWITCH WIRE



Loosen the three screws attaching the right handlebar switch housing.
Disconnect the clutch cable.
Remove the three screws holding the left handlebar switch housing.
Remove the wire bands.
Remove the left grip and the clutch lever holder.

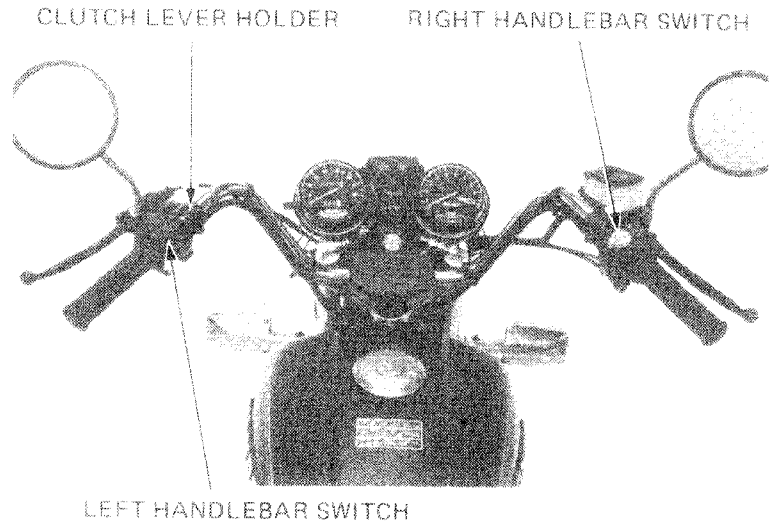

Remove the fuse plate cover.
Remove the four upper holder socket bolts and upper holder.
Remove the handlebar.

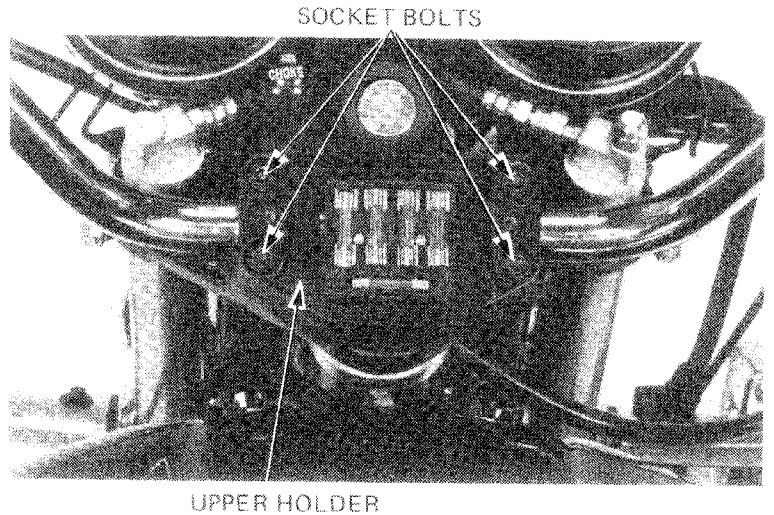

INSTALLATION

Installation of the handlebar is essentially the reverse order of removal.

NOTE

Coat the throttle grip area of the handlebar with grease.

Align the punch marks on the handlebar with the split of the upper holder and fork bridge.
Tighten the forward socket bolts first, then tighten the rear socket bolts.

TORQUE: 25–35 N·m
(2.5–3.5 kg·m, 18–25 ft·lb)

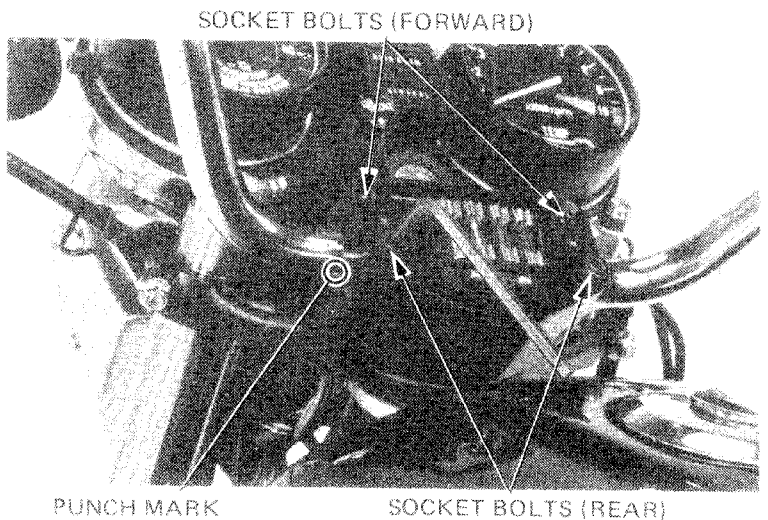

Insert the pin on the bottom half of each switch assembly into the hole in the handlebar. Tighten the forward screws first, then tighten the rear screws to the same torque.

CAUTION

Make sure the wire harness is not pinched between the switch assembly and the handlebar.

Position the clutch lever holder so the gap aligns with the punch mark on the handlebar and tighten the bolt securely.

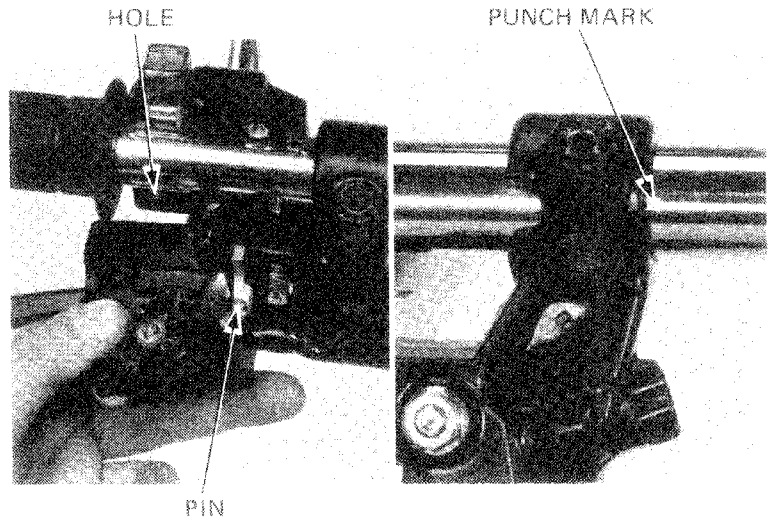

Position the master cylinder on the handlebar. Loosely install the holder with the "UP" mark facing upward using the two bolts. Align the lug on the holder with the punch mark on the handlebar. Tighten the upper bolt first, then tighten the lower bolt. Apply contact cement to the left handlebar grip and push it into place.

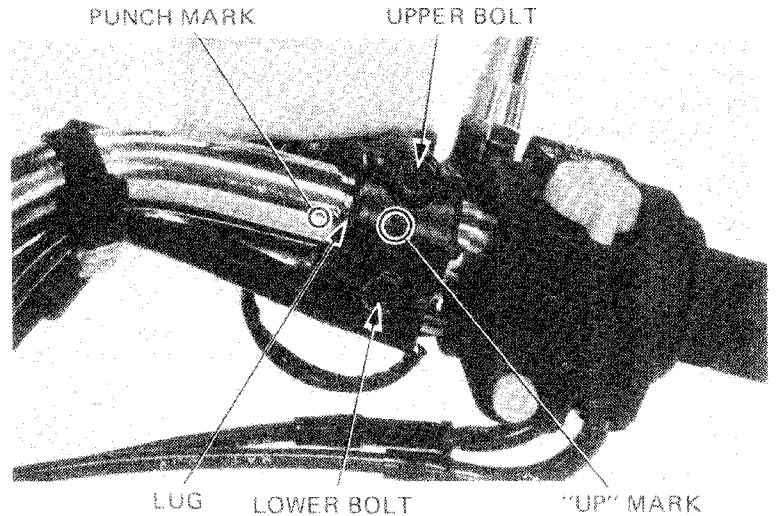

FRONT WHEEL

FRONT WHEEL REMOVAL

Raise the front wheel off the ground by placing a block or safety stand under the engine. Disconnect the speedometer cable from the speedometer gearbox.

INTERSTATE MODEL

Remove either the left or right caliper by removing the caliper mounting bolts. Support the caliper so that it doesn't hang from the brake hose.

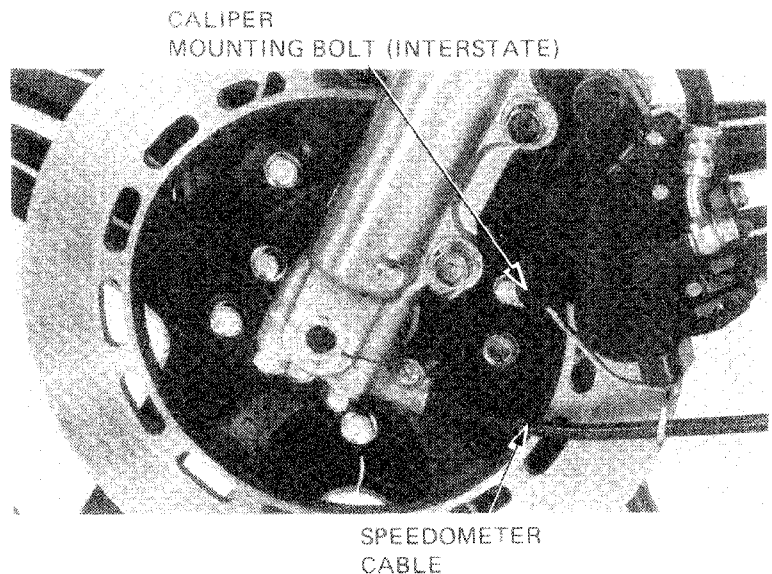



Remove the right and left front axle holders.
Jack up the bike until the fork legs lift free of the axle and remove the front wheel.

NOTE

Do not operate the front brake lever after removing the front wheel. To do so will cause difficulty in refitting the brake disc between the brake pads.

AXLE HOLDER

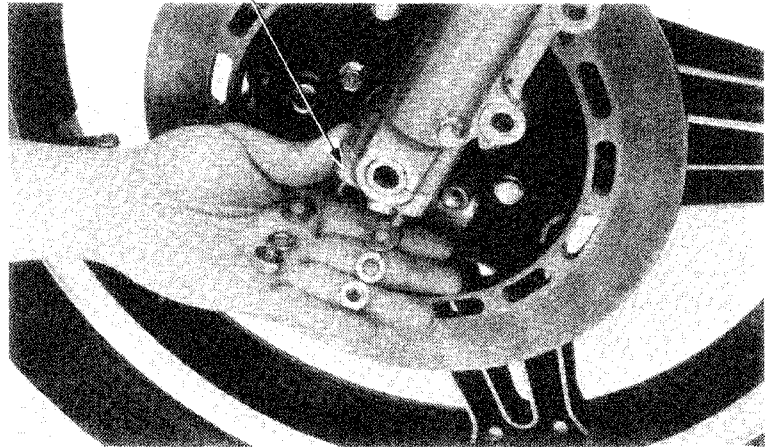

AXLE INSPECTION

Set the axle in V blocks and measure the runout. The actual runout is 1/2 of the total indicator reading.

SERVICE LIMIT: 0.2 mm (0.01 in)

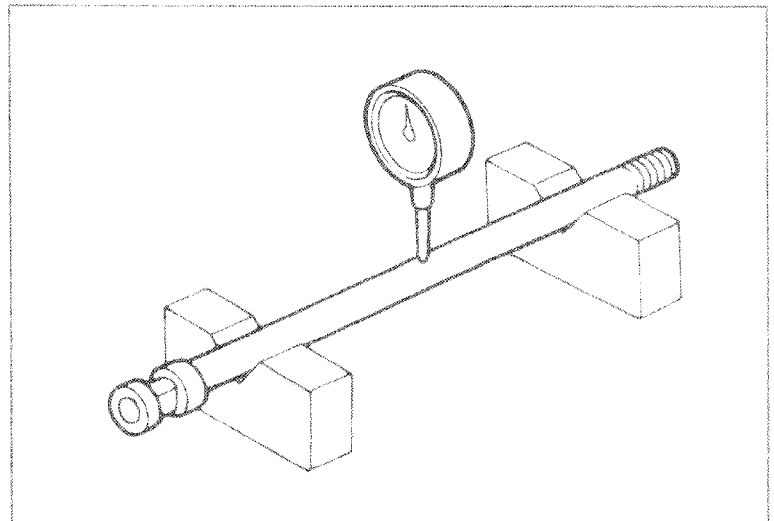

WHEEL BEARING INSPECTION

Check the wheel bearing play by placing the wheel in a truing stand and spinning the wheel by hand. Replace the bearings with new ones if they are noisy or have excessive play.

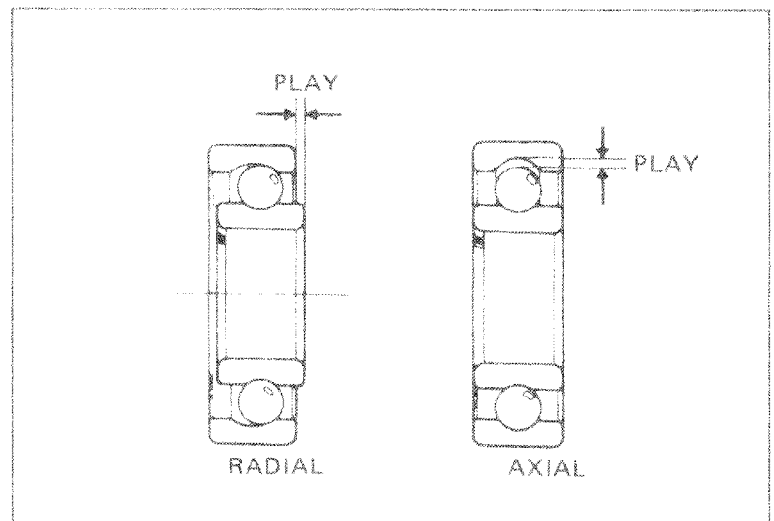



FRONT WHEEL/SUSPENSION

WHEEL INSPECTION

Place the wheel in a truing stand. Spin the wheel slowly and measure the runout with a dial indicator gauge.

SERVICE LIMITS:

RADIAL RUNOUT: 2.0 mm (0.08 in)

AXIAL RUNOUT: 2.0 mm (0.08 in)

NOTE

The COMSTAR WHEEL cannot be repaired and must be replaced if the service limits are exceeded.

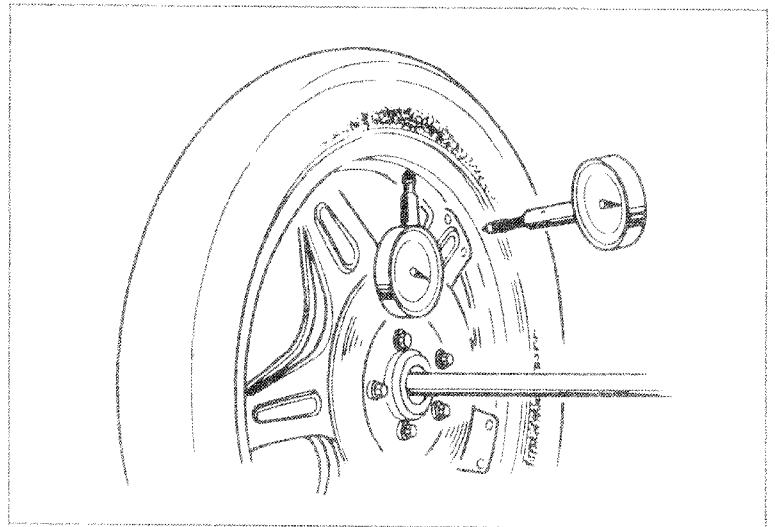

FRONT WHEEL DISASSEMBLY

Remove the axle nut, speedometer gear box, axle and collar.

AXLE NUT

SPEEDOMETER GEAR BOX

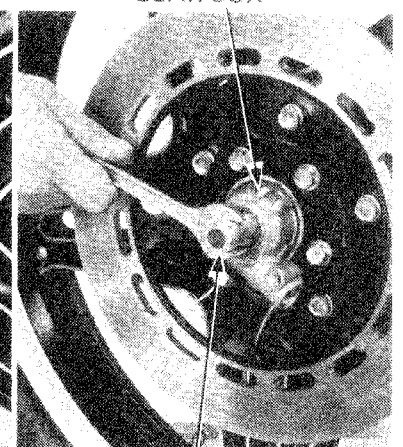
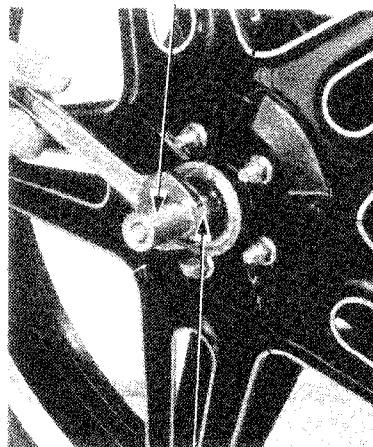

COLLAR

AXLE

Remove the bearing retainer.

RETAINER WRENCH BODY

RETAINER WRENCH ATTACHMENT

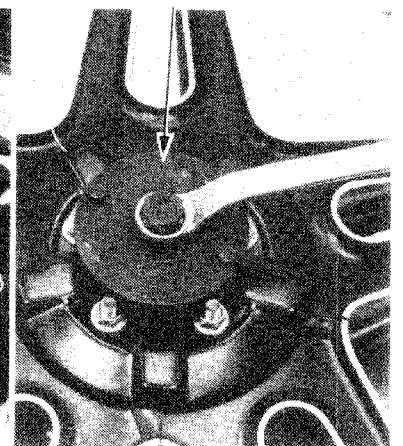
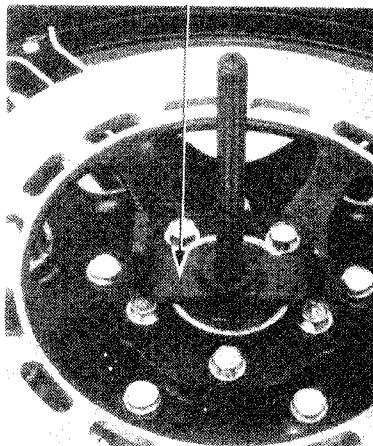



Remove the disc bolts, disc and dust seal.
Remove the bearings and the distance collar from the hub.

NOTE

If the bearings are removed, replace them with new bearings during assembly.

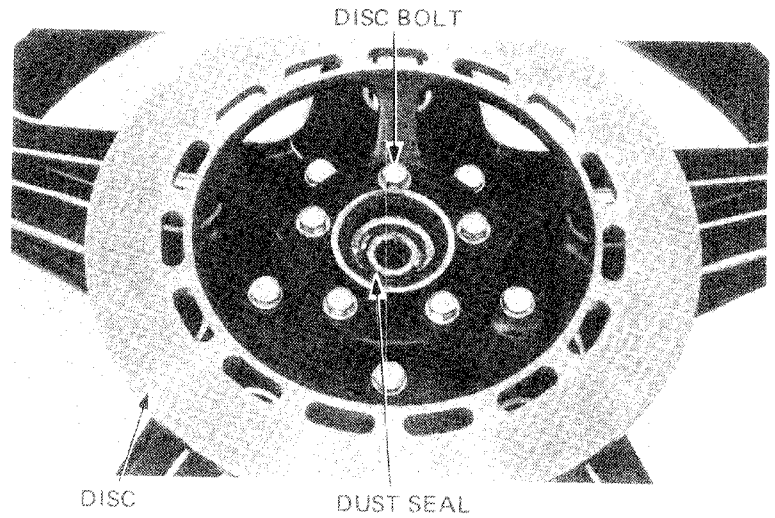

FRONT WHEEL ASSEMBLY

WARNING

Do not get grease on the brake disc.

NOTE

- * The COMSTAR WHEEL has no rim band.
- * Install the bearings with the closed end facing out.

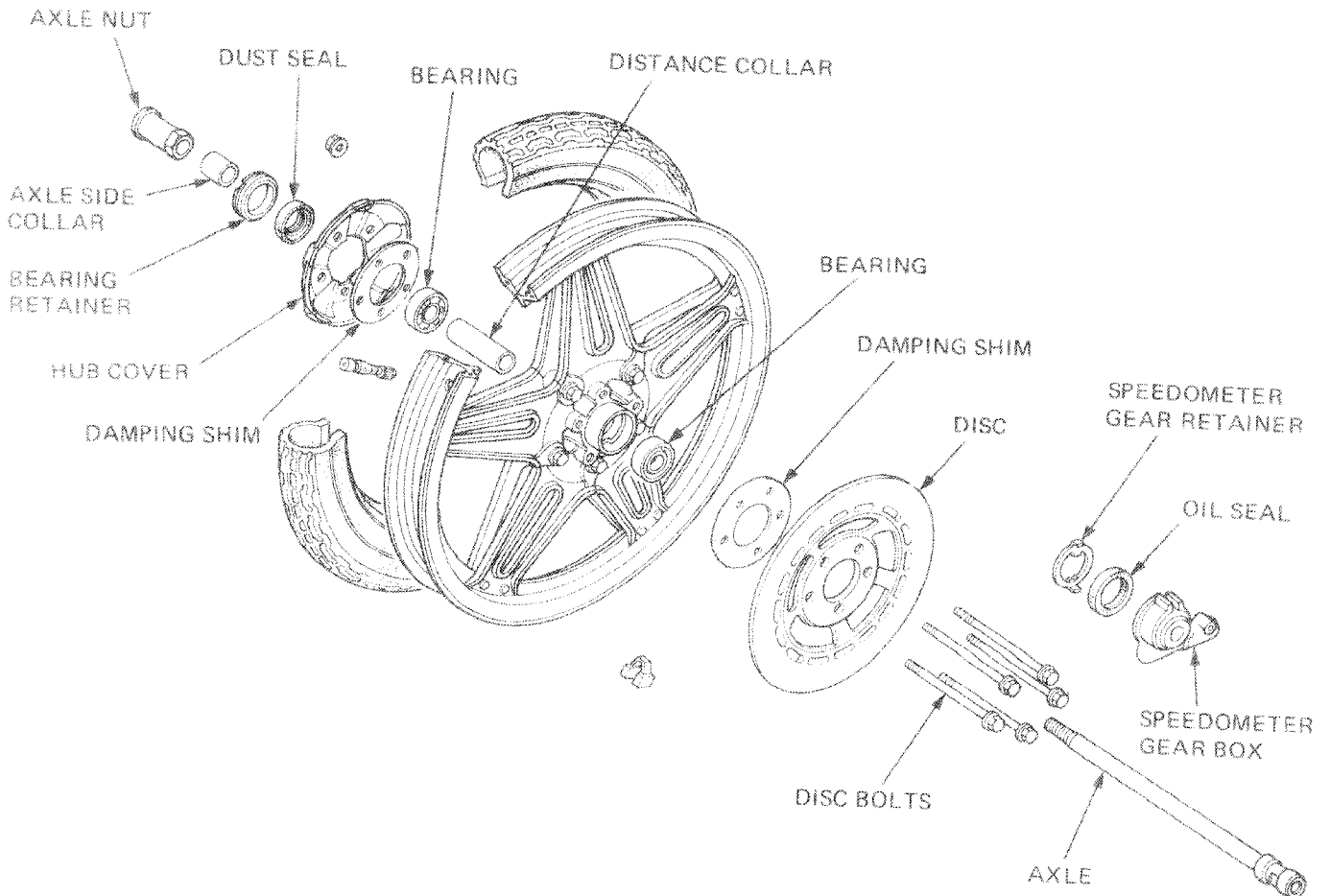

Install the disc, disc bolts and nuts.

TORQUE: 27–33 N·m
(2.7–3.3 kg·m, 20–24 ft·lb)

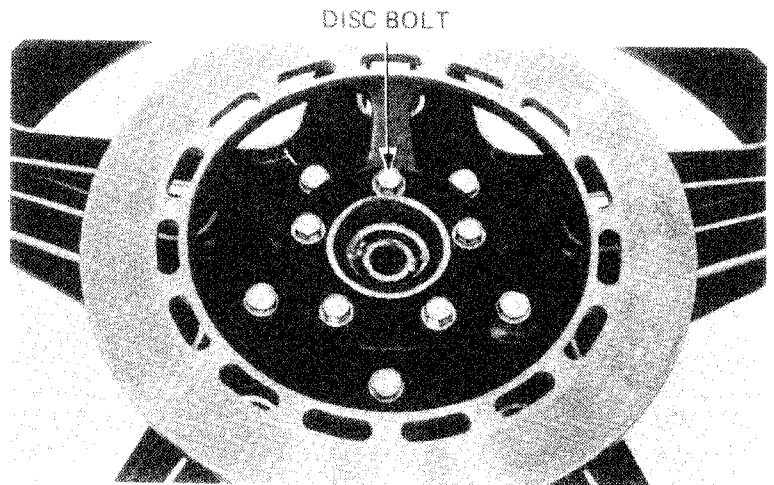

Pack all bearing cavities with grease.
Drive in the right bearing first.
Press the distance collar into place.

NOTE

Be certain the distance collar is in position before installing the left bearing.

Drive in the left bearing.

NOTE

Drive the bearing squarely. Make sure that it is fully seated and that the sealed side is facing out.

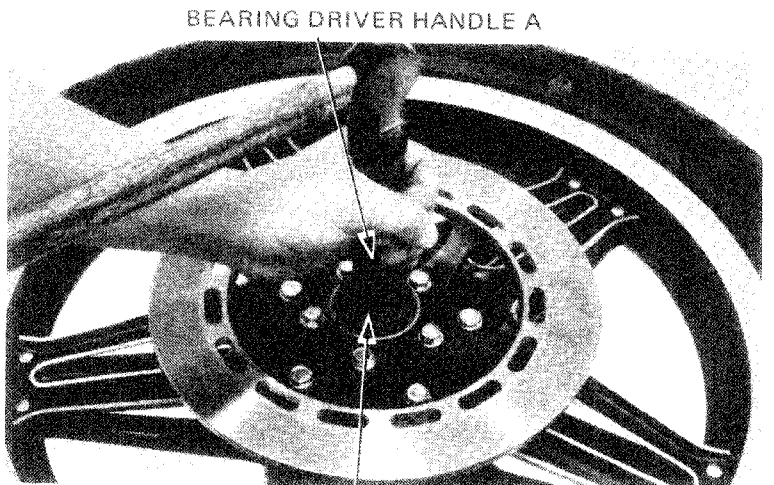

ATTACHMENT 42 x 47 mm
PILOT 15 mm

Inspect the bearing retainer; replace it if the threads are damaged.
Install the bearing retainer.

Lubricate the dust seal lip with grease.
Install the dust seal and collar in the hub.
Peen the edge of the retainer.

NOTE

The spoke plate bolts and nuts require no retightening since they are secured with lock pins. Do not remove the pins.

CAUTION

Remove all the grease around the outside of the dust seal.

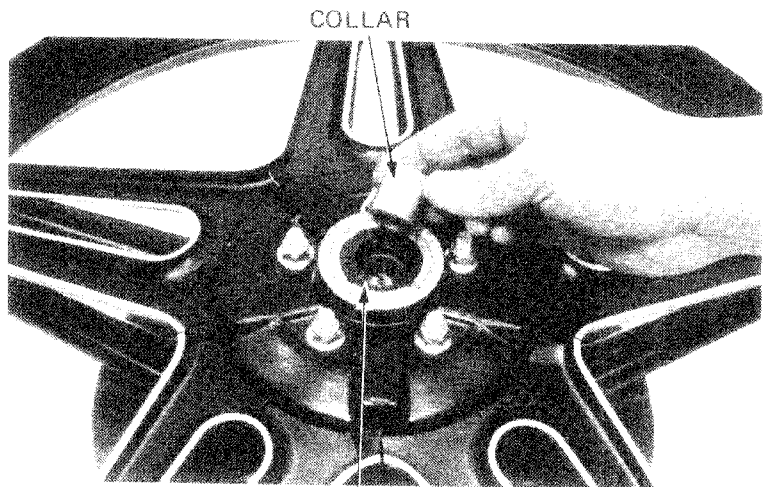

DUST SEAL



Install the speedometer gear retainer in the hub from the left side.

Lubricate the oil seal lip and install.

Disassemble the speedometer gear box and lubricate the gears and sliding surfaces.

Install the speedometer gear in the wheel hub, aligning the gear box notches with the tangs in the retainer.

CAUTION

Remove all the grease around the outside of the oil seal.

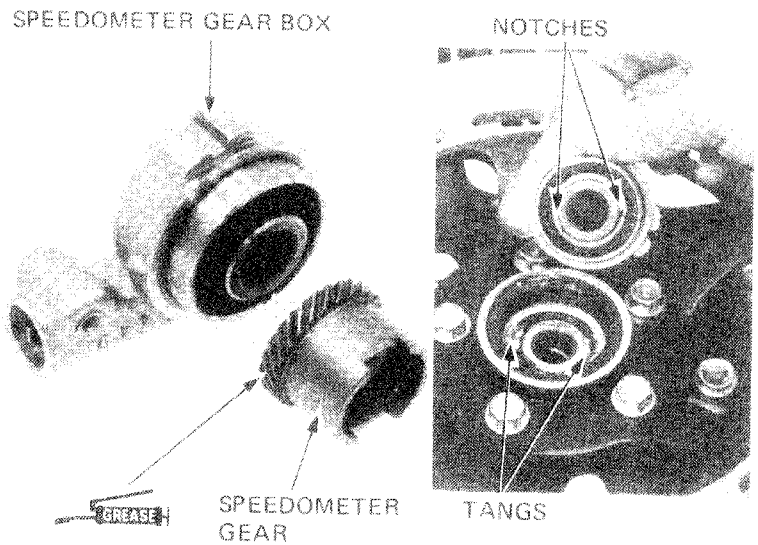

Install the axle and axle nut, then tighten the axle nut.

TORQUE: 55–65 N·m
(5.5–6.5 kg·m, 40–47 ft·lb)

Clean the brake disc with a high quality degreasing agent.

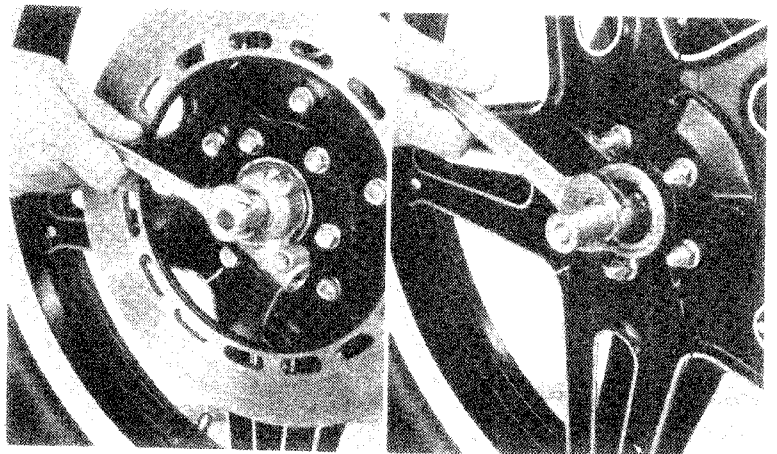

FRONT WHEEL INSTALLATION

Fit the brake disc carefully between the pads of the caliper already in place and lower the forks on the axle. Be sure that the lug on the speedometer gear box is behind the left fork leg lug.

Install the axle holders with the "F" mark and arrow forward.

Tighten the axle holders nuts starting with the forward nuts.

TORQUE: 18–25 N·m
(1.8–2.5 kg·m, 13–18 ft·lb)

Connect the speedometer cable to the speedometer gearbox.

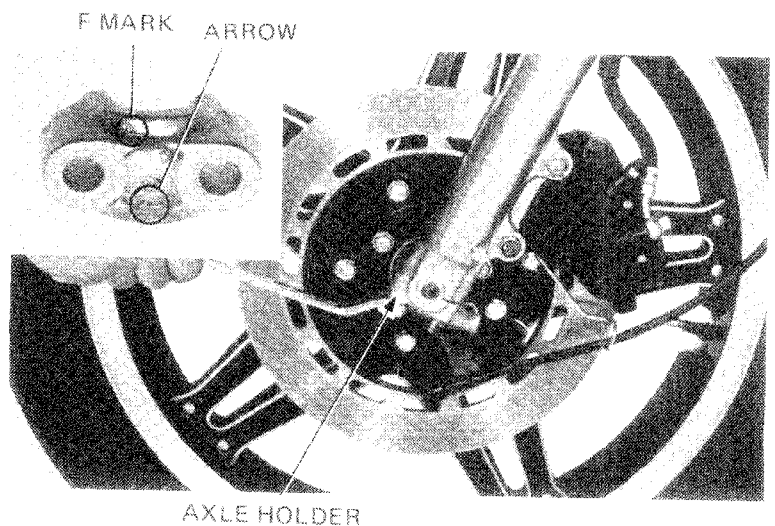

FRONT FORK

FRONT FORK REMOVAL

- Remove the front wheel (Page 13-6).
- Remove the brake caliper by unscrewing the caliper mount bolts.
- Remove the brake hose clamp.

NOTE

Do not loosen the brake hose unless necessary.

Remove the front fender.

FRONT FENDER

HOSE CLAMP

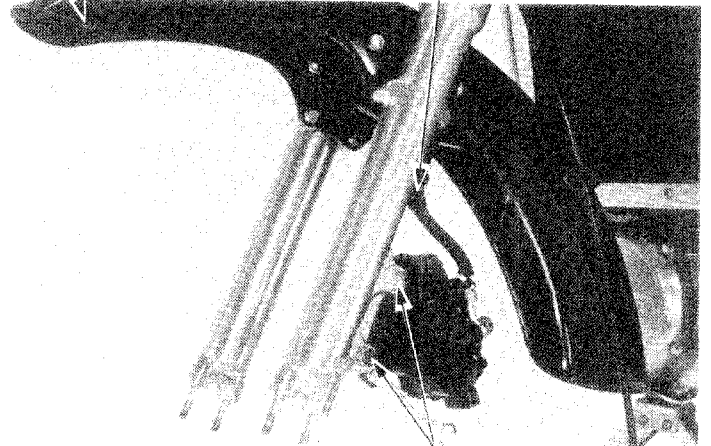

CALIPER MOUNT BOLTS

- Remove the indicator light cover.
- Disconnect the air hose from the right fork connector.
- Remove the connector from the right fork cap bolt.
- Remove the air hose from the left fork cap bolt.

AIR HOSE

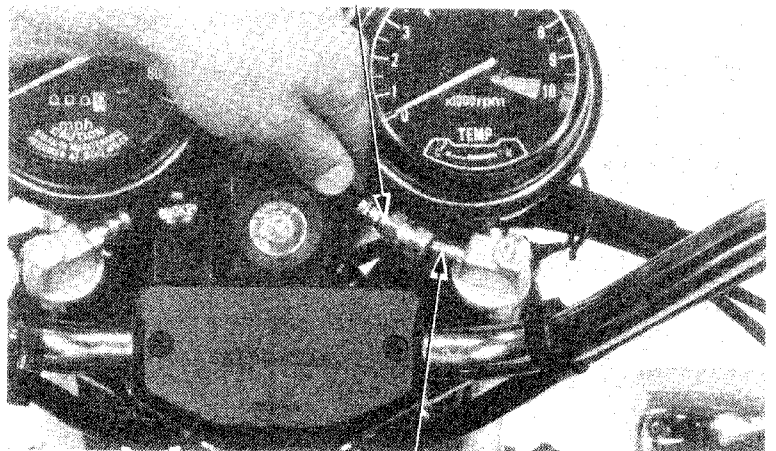

CONNECTOR

- Loosen the fork pinch bolts.
- Remove the fork tubes, rotating them by hand if necessary.

FORK PINCH BOLTS

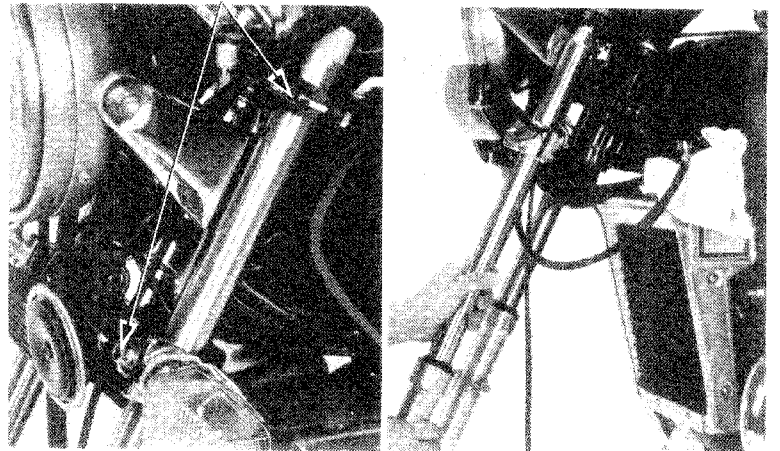



FRONT FORK DISASSEMBLY

Hold the fork tube in a vise.
Remove the fork cap bolt.

CAUTION

Do not damage or bend the sliding surface.

WARNING

Use care when loosening the bolt or the spring will pop out as a projectile, which may cause injury.

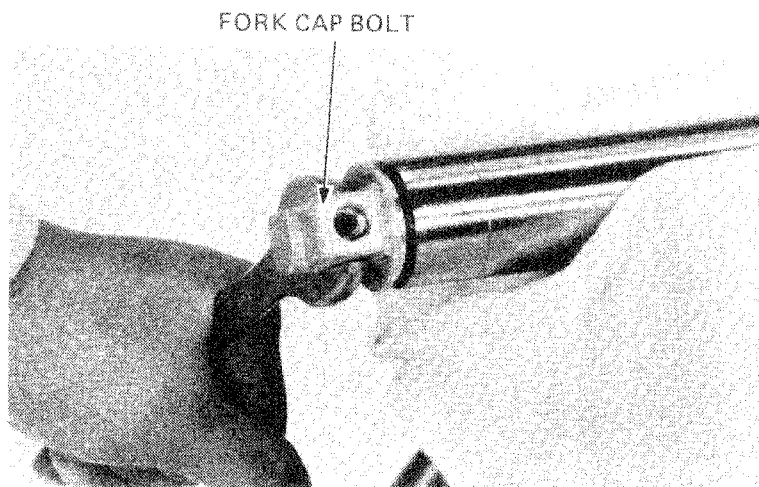

Remove the fork spring.
Pour out any remaining fork fluid by pumping the fork up and down several times.

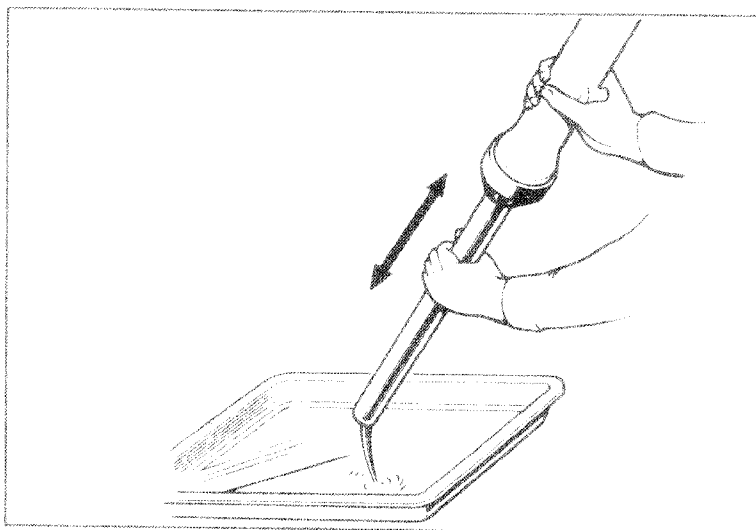

Hold the fork slider in a vise with soft jaws.
Remove the hex bolt.

CAUTION

Excessive vise pressure can damage the fork slider.

NOTE

Temporarily install the spring and fork bolt if difficulty is encountered in removing the bolt.

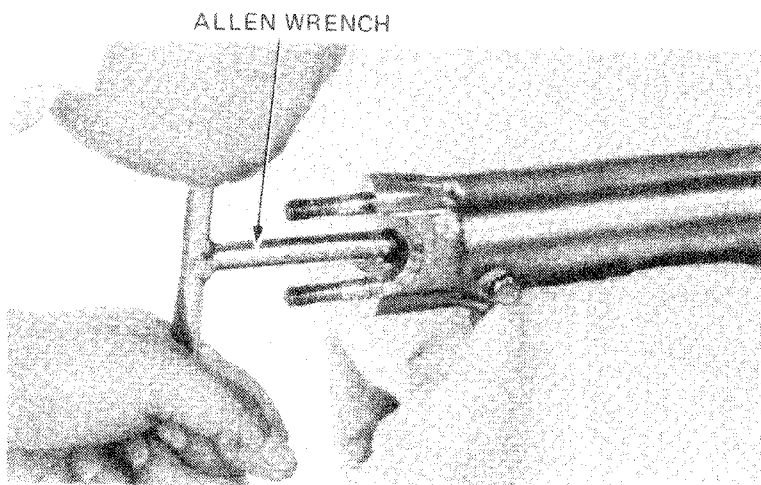



FRONT WHEEL/SUSPENSION

Remove the dust seal, circlip and back-up plate.

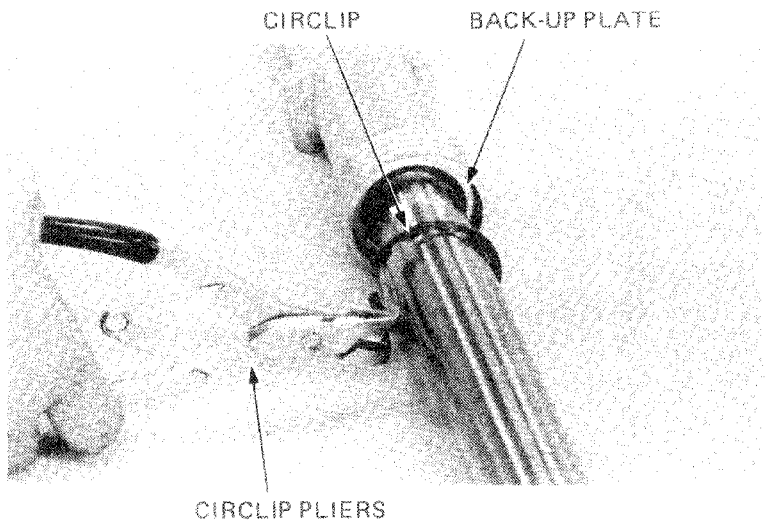

Remove the fork tube from the slider by pumping it in and out several times.

NOTE

The slider bushing causes resistance and the fork tube bushing must force it out.

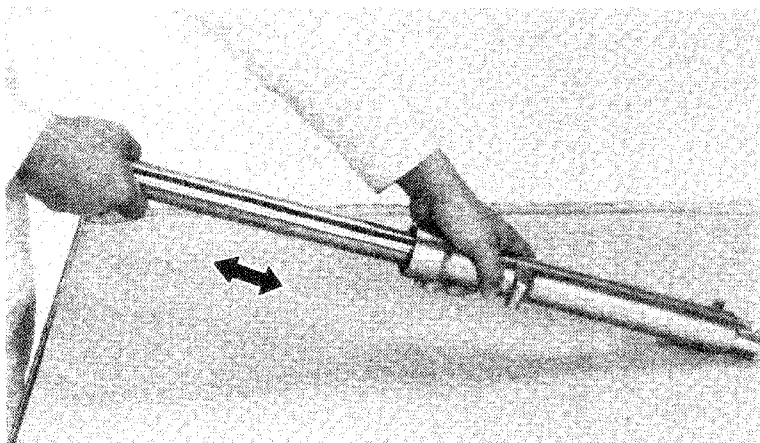

Remove the oil seal, back-up ring and slider bushing from the fork tube.

NOTE

Do not remove the fork tube bushing unless it is necessary to replace it with a new one.

Remove the piston from the fork tube and the oil lock piece from the slider.

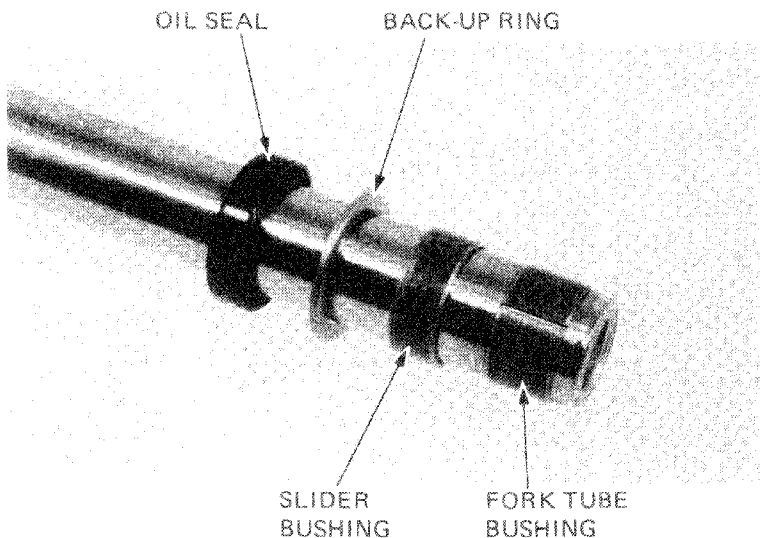



FRONT FORK SPRING FREE LENGTH INSPECTION

Measure the fork springs free length.

SERVICE LIMIT:

UPPER: 97.7 mm (3.85 in)

LOWER: 493 mm (19.4 in)

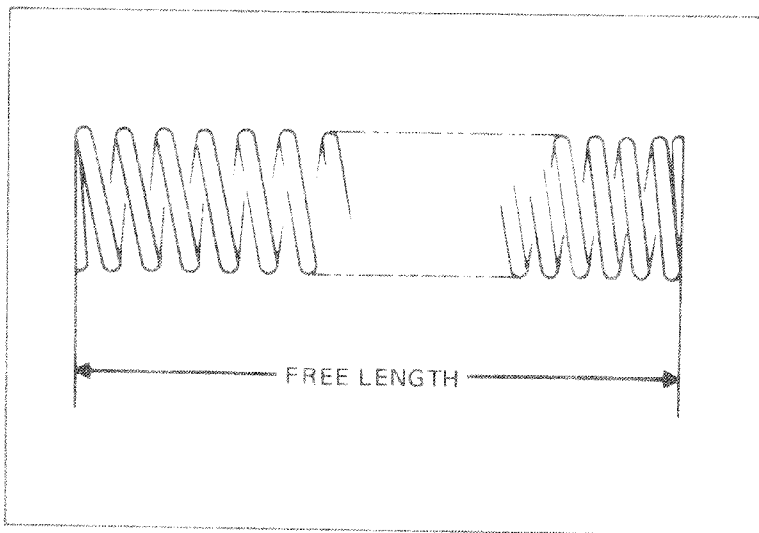

FORK TUBE/FORK SLIDER/PISTON INSPECTION

Check the fork tubes, fork sliders and pistons for score marks, scratches, or excessive or abnormal wear.

Replace any components which are worn or damaged.

Check the fork piston ring for wear or damage.

Check the rebound spring for fatigue or damage.

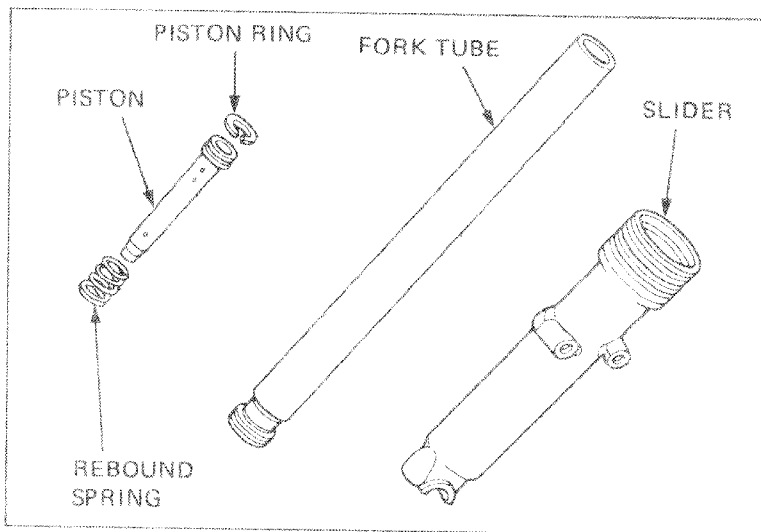

FORK TUBE INSPECTION

Set the fork tube in V blocks and read the runout. Take 1/2 the total indicator reading to determine the actual runout.

SERVICE LIMIT: 0.20 mm (0.008 in)

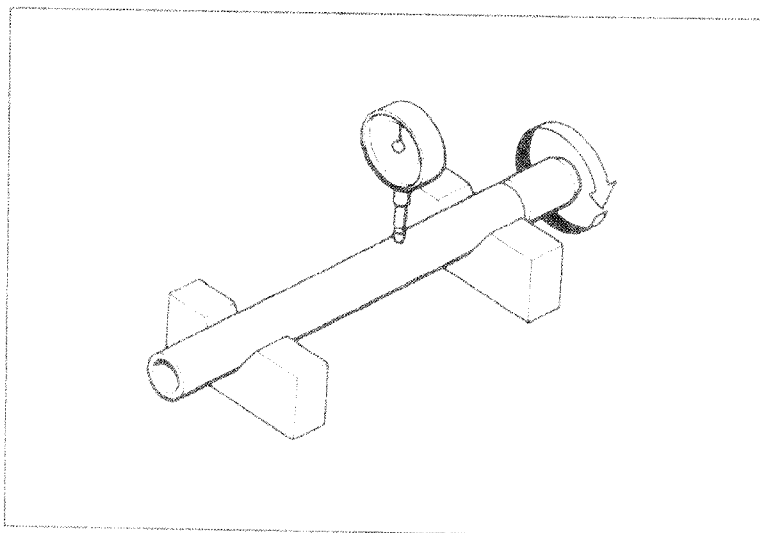

FRONT WHEEL/SUSPENSION

BUSHING/BACK-UP RING INSPECTION

Visually inspect the slider and fork tube bushings. Replace the bushings if there is excessive scoring or scratching, or if the teflon is worn so that the copper surface appears on more than 3/4 of the entire surface. Check the back-up ring; replace it if there is any distortion at the points shown.

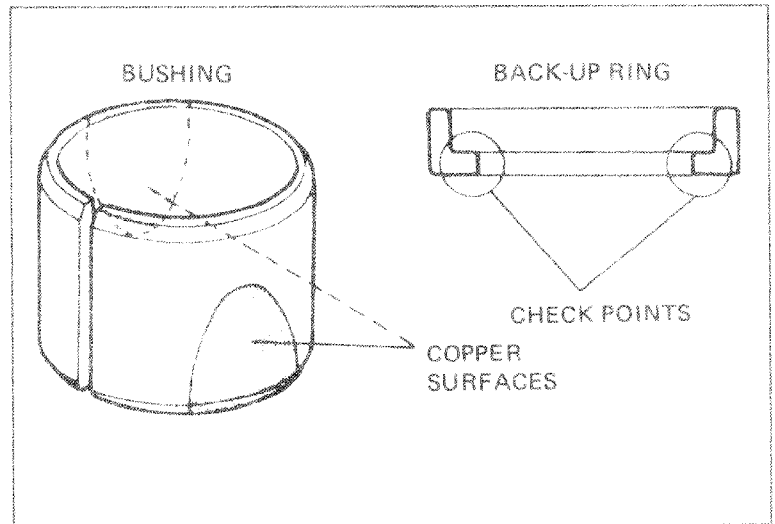

FRONT FORK ASSEMBLY

Before assembly, wash all parts with a high flash point or non-flammable solvent and wipe them off completely.

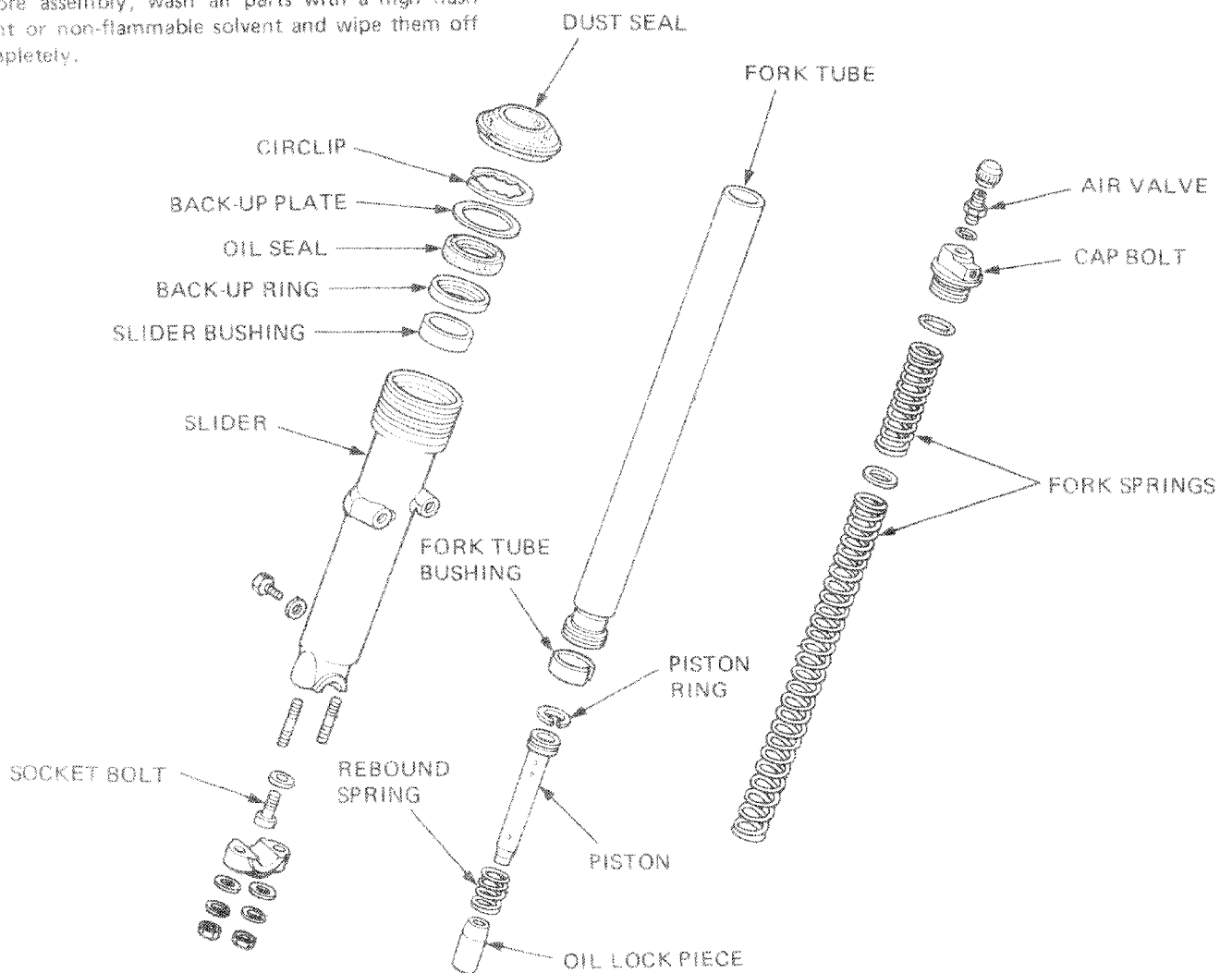



Install a new bushing on the fork tube if necessary.
Place the rebound spring and piston into the fork tube.
Place the oil lock piece on the end of the piston.
Insert the fork tube into the slider.

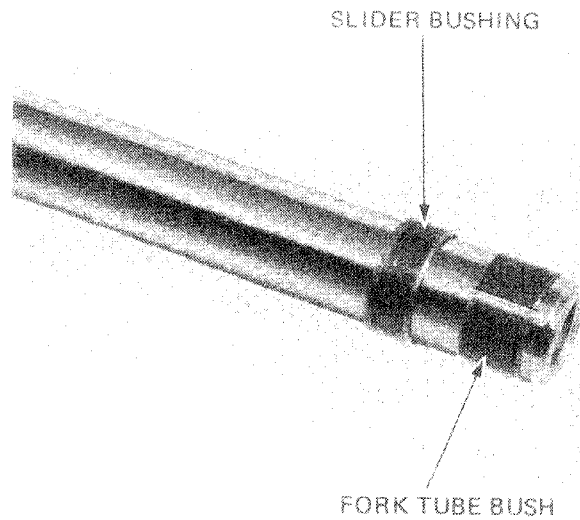

Place the fork slider in a vise with soft jaws.
Apply a locking agent to the socket bolt and thread it into the piston. Tighten with a 6 mm hex wrench.

NOTE

Temporarily install the fork spring and fork cap bolt to tighten the socket bolt.

TORQUE: 15–25 N·m
(1.5–2.5 kg·m, 11–18 ft·lb)

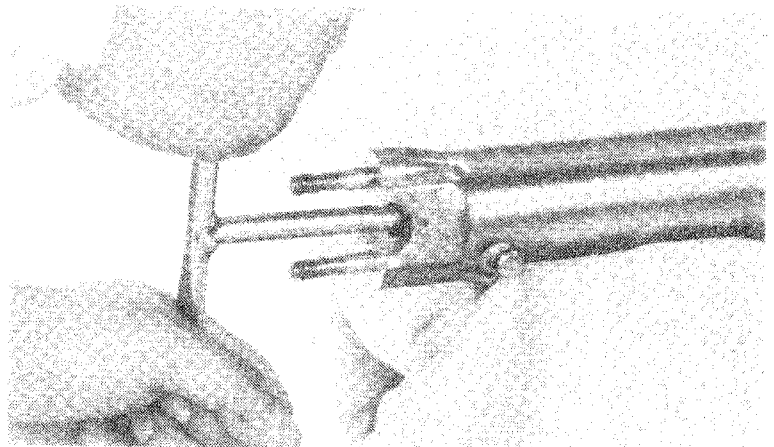

Place the slider bushing over the fork tube and rest it on the slider. Put the back-up ring and an old bushing or equivalent tool on top.
Drive the bushing into place with the seal driver.
Remove the old bushing.

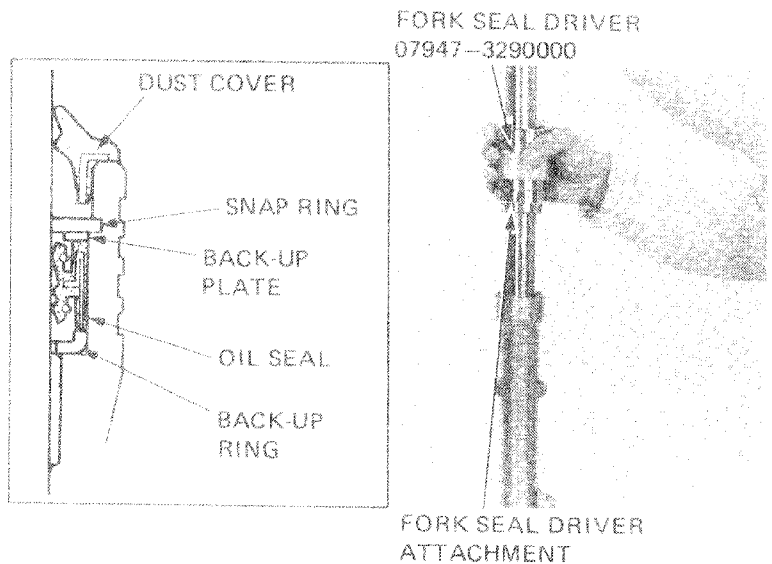

FRONT WHEEL/SUSPENSION

Install the back-up ring.
Coat a new oil seal with ATF and install it with the seal marking facing up.

NOTE

Before installing the oil seal, check the groove and top edge of the fork tube for burrs or scratches.
Wrap the fork tube groove or top edge with vinyl tape to prevent damage to the oil seal lip, if necessary.

Drive the oil seal in with the seal driver.

NOTE

If additional seal depth is needed, install the back-up plate and repeat driving the seal in.

Install the back-up plate, circlip and dust cover.
Pour the specified amount of ATF into the fork tube.

CAPACITY: 210 cc (7.1 oz)

NOTE

Be sure the oil level is the same in both fork tubes.

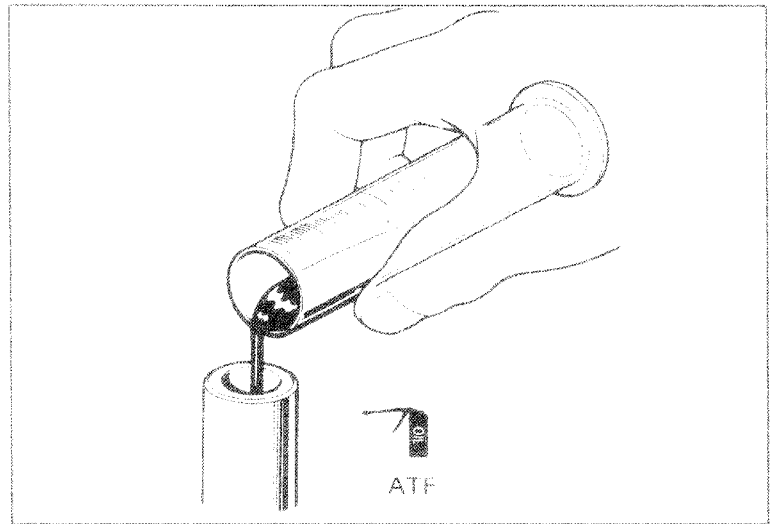
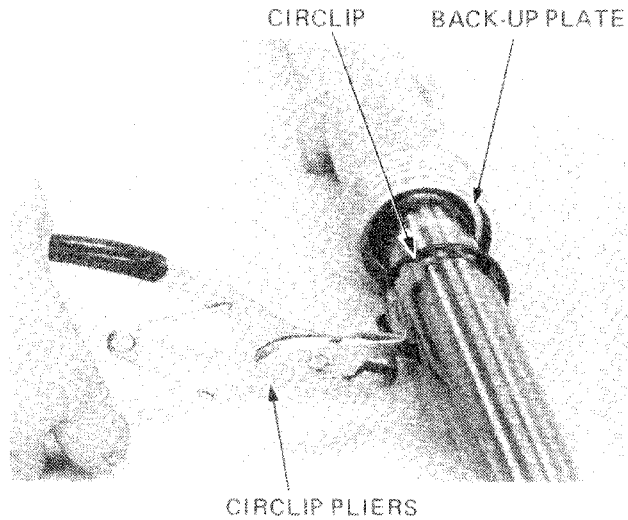

Wipe all oil from the fork springs and install them into the fork tube.

Install and torque the fork cap bolt.

TORQUE: 15–30 N·m
(1.5–3.0 kg-m, 11–22 ft-lb)

NOTE

- Place the fork tube in soft jaws, avoiding the sliding surface.
- Note the spring direction. The narrow coils should face down.

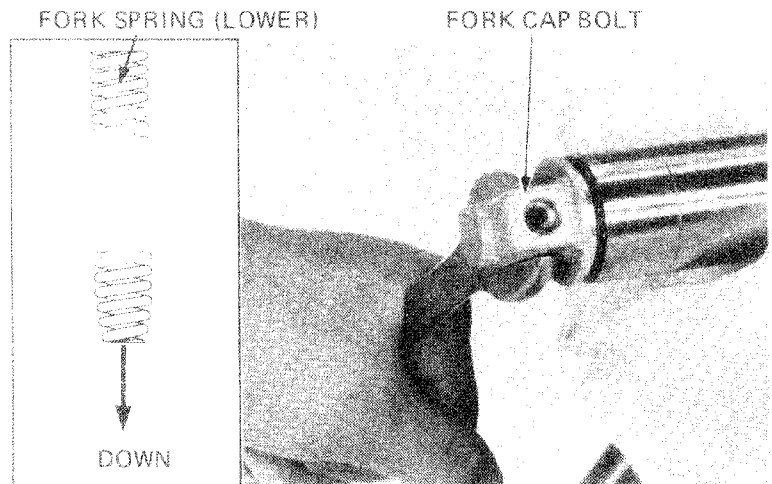



FRONT FORK INSTALLATION

Install the fork tube in the fork bridge and steering stem.
Tighten the fork tube pinch bolts loosely.

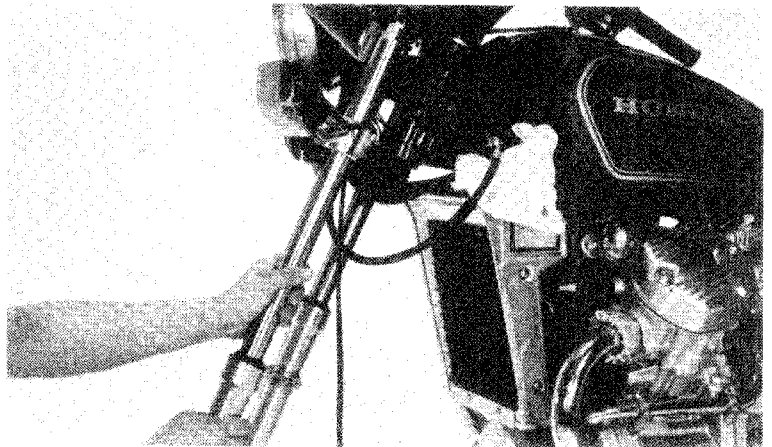

Apply grease to a new O-ring and install the air hose into the left fork cap bolt.
Apply grease to a new O-ring and install the connector into the right fork cap bolt.

TORQUE: 4–7 N·m
(0.4–0.7 kg-m, 3–5 ft-lb)

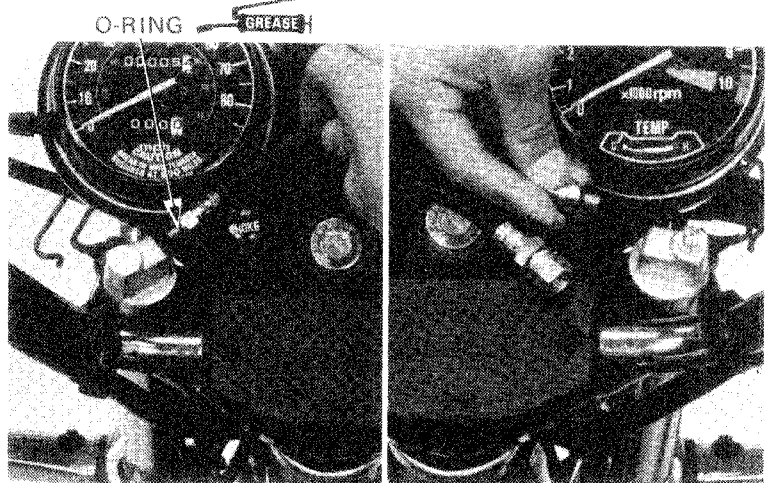

Loosen the fork tube pinch bolts.
Turn the fork tubes so that the air hose has a natural curve.
Attach the air hose to the connector and tighten the hose joint nut.

TORQUE: 15–20 N·m
(1.5–2.0 kg-m, 11–14 ft-lb)

Install the indicator panel cover.
Align the groove of each fork tube with the top surface of the fork bridge.

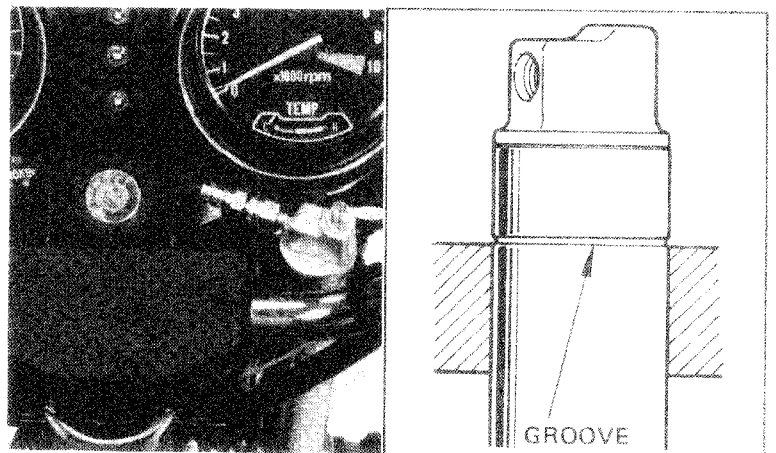



Tighten the fork bridge and steering stem pinch bolts.

TORQUE:

FORK BRIDGE PINCH BOLT:

9–15 N·m (0.9–1.5 kg·m, 7–11 ft·lb)

STEERING STEM PINCH BOLT:

30–40 N·m (3.0–4.0 kg·m, 22–29 ft·lb)

UPPER FORK PINCH BOLT

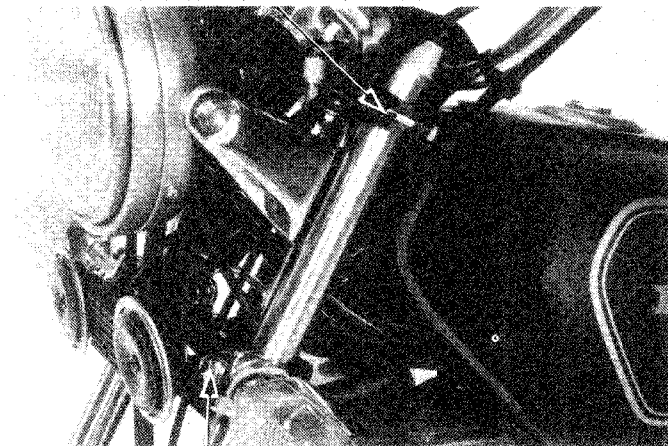

LOWER FORK PINCH BOLT

Install the front brake caliper.
Torque the caliper mount bolts.

TORQUE: 30–45 N·m

(3.0–4.5 kg·m, 22–23 ft·lb)

Install the front fender and secure the brake hose.
Install the front wheel (Page 13-11).

FRONT FENDER

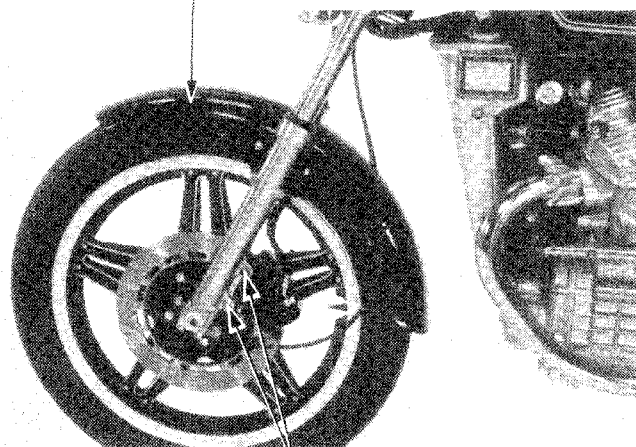

CALIPER MOUNTING BOLTS

Make sure all weight is off the front wheel, and charge the forks with air.

RECOMMENDED PRESSURE:

80–120 kPa (0.8–1.2 kg/cm², 11–17 psi)

CAUTION

Use a low-volume, low-pressure pump to charge the forks. Excessive pressure can damage the fork tube components.

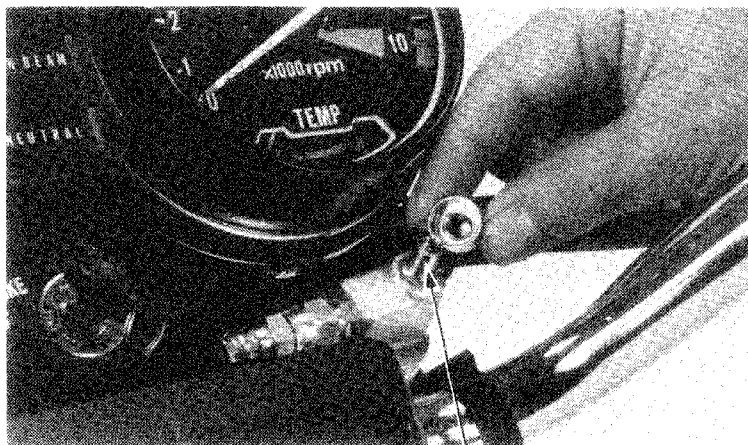

AIR VALVE



STEERING STEM

STEERING STEM REMOVAL

Remove the headlight case (Page 13-3).
Remove the instruments (Page 13-4).
Remove the handlebar (Page 13-4).
Remove the headlight case bracket and the ignition switch.

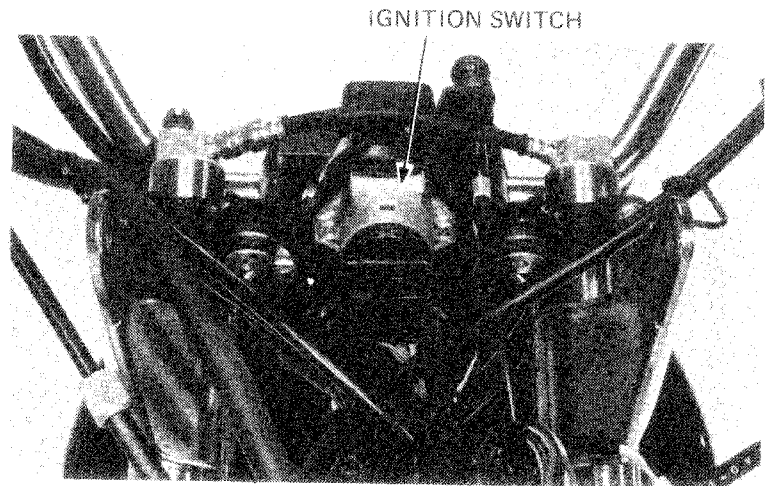

Remove the horn cover.
Remove the horns and horn bracket from the steering stem.

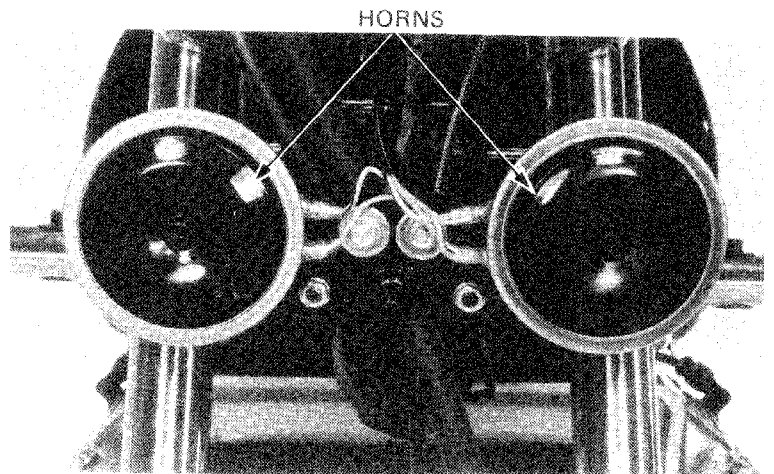

Remove the right and left turn signals.

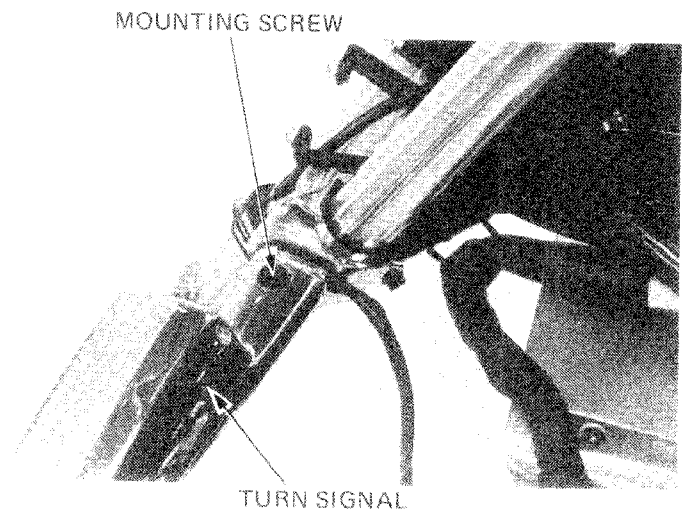

Disconnect the fork air hose (Page 13-12).

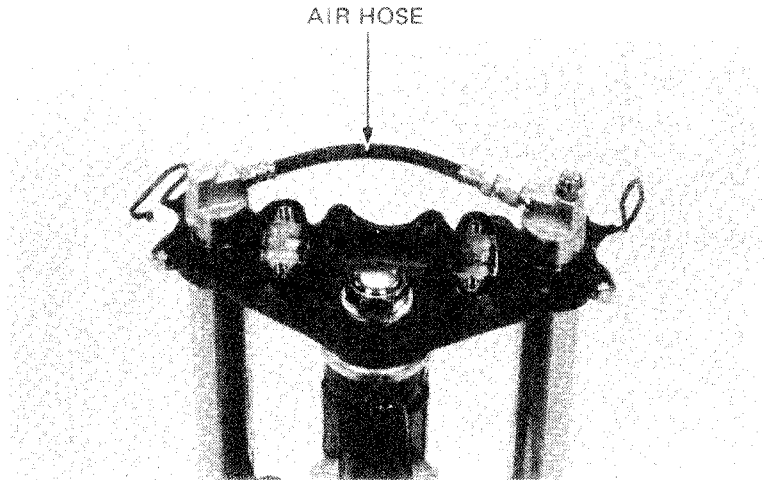

Remove the steering stem nut.
Loosen the pinch bolts and remove the fork bridge and front forks.

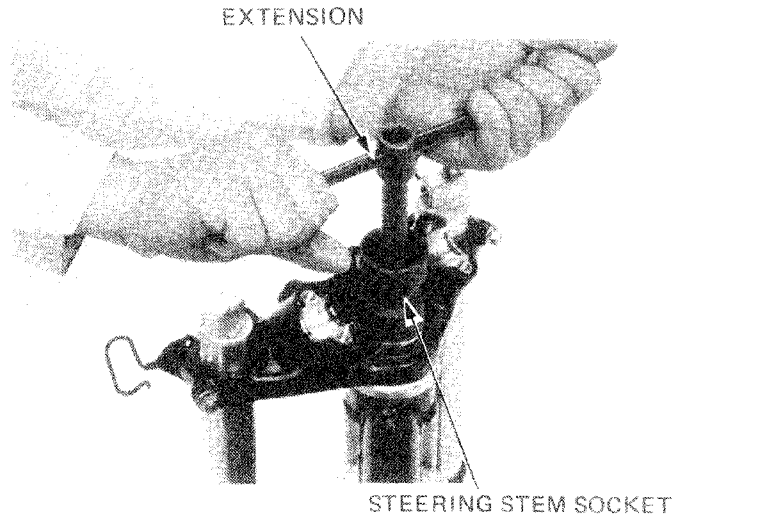

Remove the steering stem adjuster nut.

NOTE

Hold the steering stem to prevent the steel balls and the stem from falling.

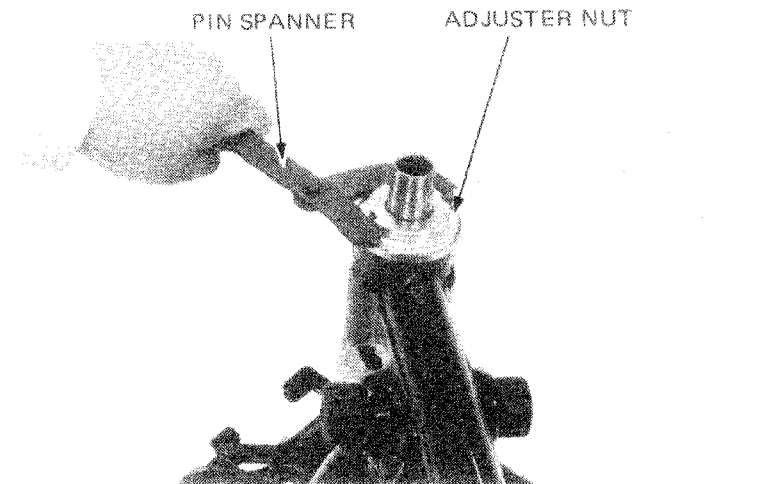



Remove the top cone race and upper bearing steel balls.
Remove the steering stem and lower bearing steel balls.

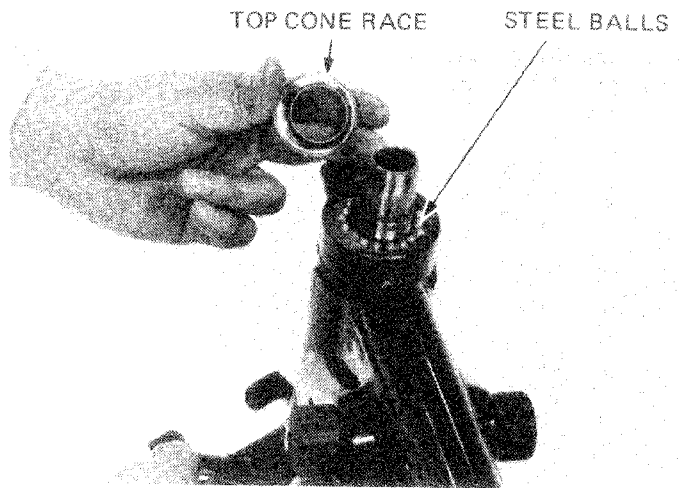

BEARING INSPECTION

Check the upper and lower bearing race surfaces for wear or damage and replace if necessary.

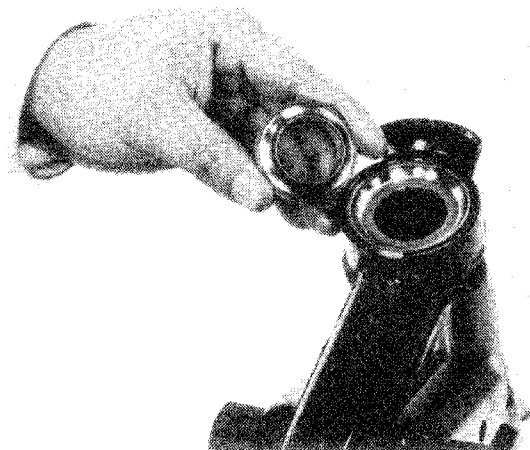

BOTTOM CONE RACE REPLACEMENT

Remove the bottom cone race with a hammer and a drift.

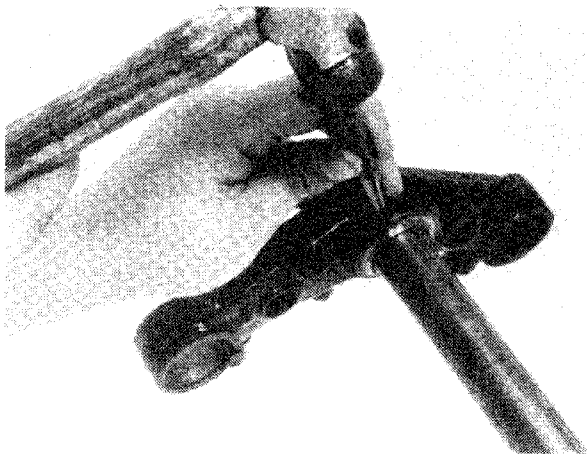

Install a new washer and dust seal.
Drive a new bottom cone race into place.

STEERING STEM DRIVER
07946-3710400 or 07946-3710601

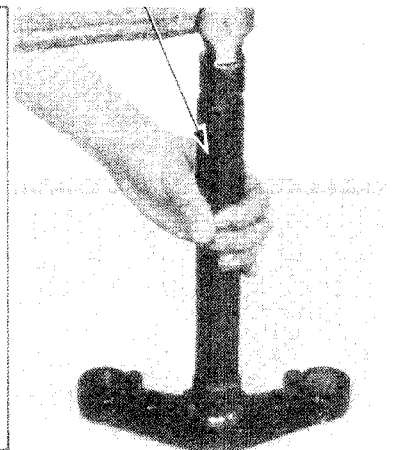
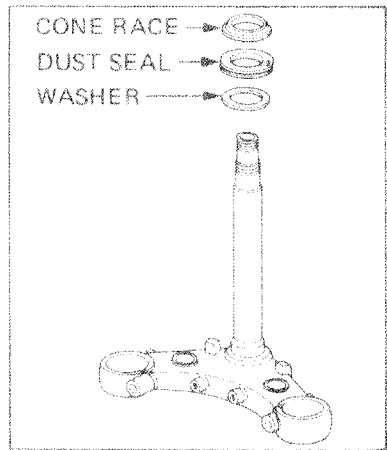

BALL RACE REPLACEMENT

Inspect the top and bottom ball races and replace if worn or damaged.
Drive out the top ball race and then drive out the bottom ball race.

NOTE

Always remove the top ball race before driving out the bottom ball race.

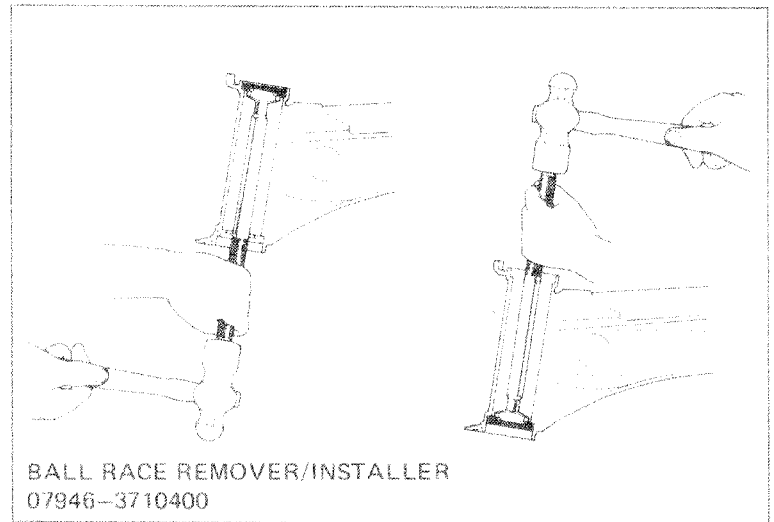

Install a new bottom ball race.

NOTE

The bottom ball race has a larger I.D. than the top ball race. Be sure to install the races in their proper places.

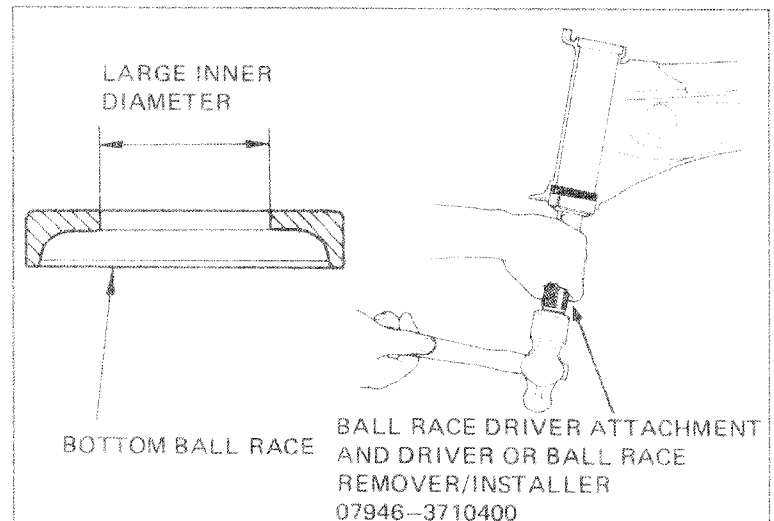



Install a new top ball race.

NOTE

Drive the ball races in squarely until they seat.

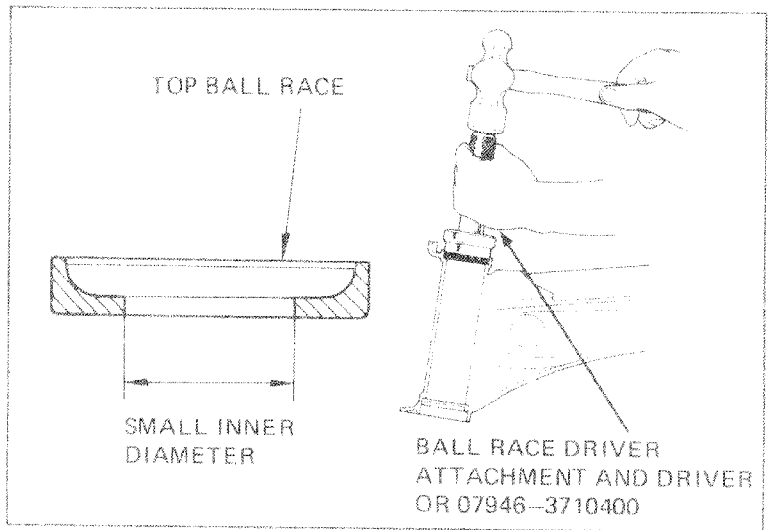

STEERING STEM INSTALLATION

Grease the top race and install 18 steel balls.
Grease the lower cone race and install 19 steel balls.

NOTE

Do not allow the balls to fall.

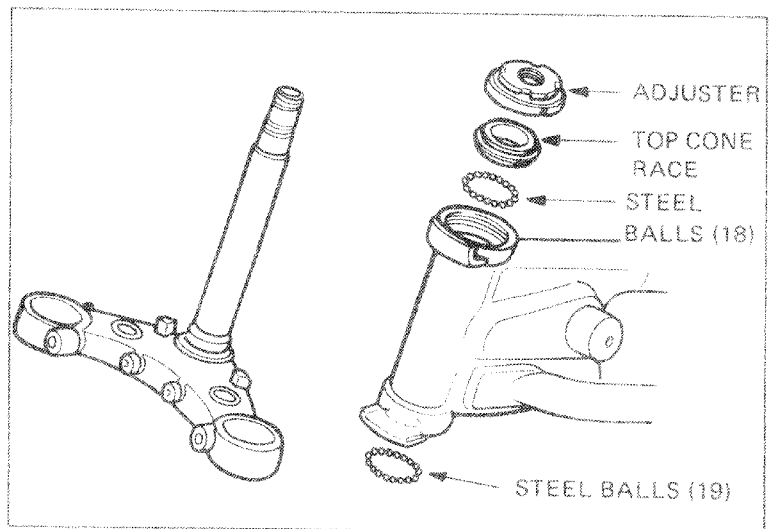

Install the adjuster nut in the frame neck and tighten it until snug against the top cone race. Then, back it out 1/8 turn. Make sure that there is no vertical movement and that the stem rotates freely.

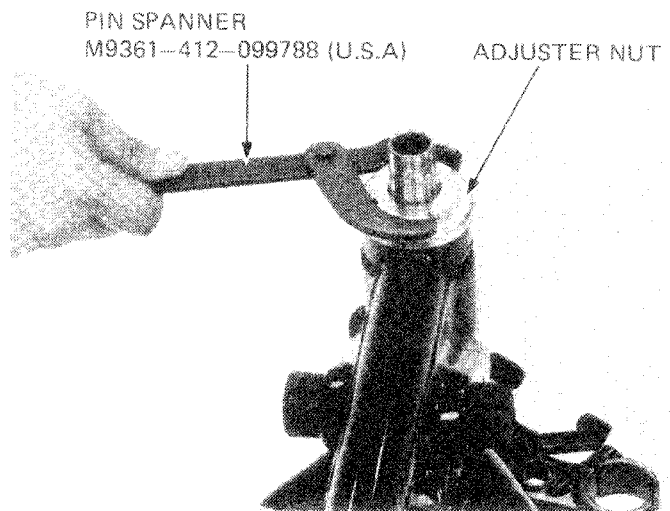



FRONT WHEEL/SUSPENSION

Install the front fork legs.

NOTE

Do not interchange the right and left fork legs.

Temporarily hold the fork tubes by tightening the steering stem bolts.

Install the fork bridge.

Install the washer and stem nut on the steering stem.

Torque the stem nut.

TORQUE: 90–120 N·m

(9.0–12.0 kg-m, 65–87 ft-lb)

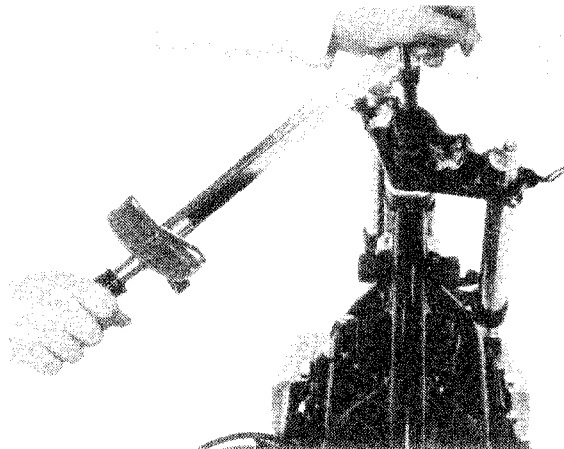

Install the fork air hose (Page 13-19).

Align the groove of each fork tube so that it is flush with the top of the fork bridge.

Tighten the pinch bolts.

TORQUE:

FORK BRIDGE PINCH BOLT:

9–15 N·m (0.9–1.5 kg-m, 7–11 ft-lb)

STEERING STEM PINCH BOLT:

30–40 N·m (3.0–4.0 kg-m, 22–29 ft-lb)

FORK AIR HOSE

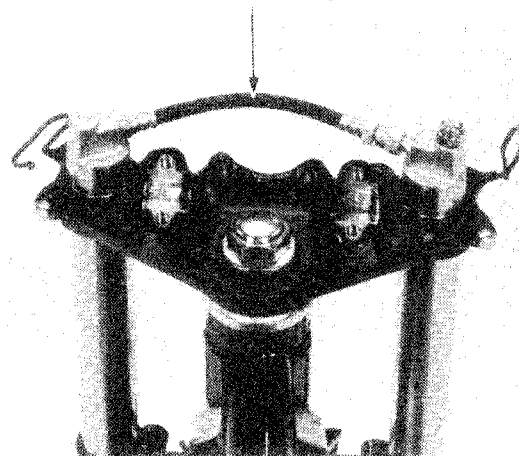

Install the removed parts in the reverse order of removal:

- * Front wheel (Page 13-11).
- * Handlebar (Page 13-5).
- * Headlight case (Page 13-3).



HONDA
GL500
GL500 INTERSTATE

MEMO

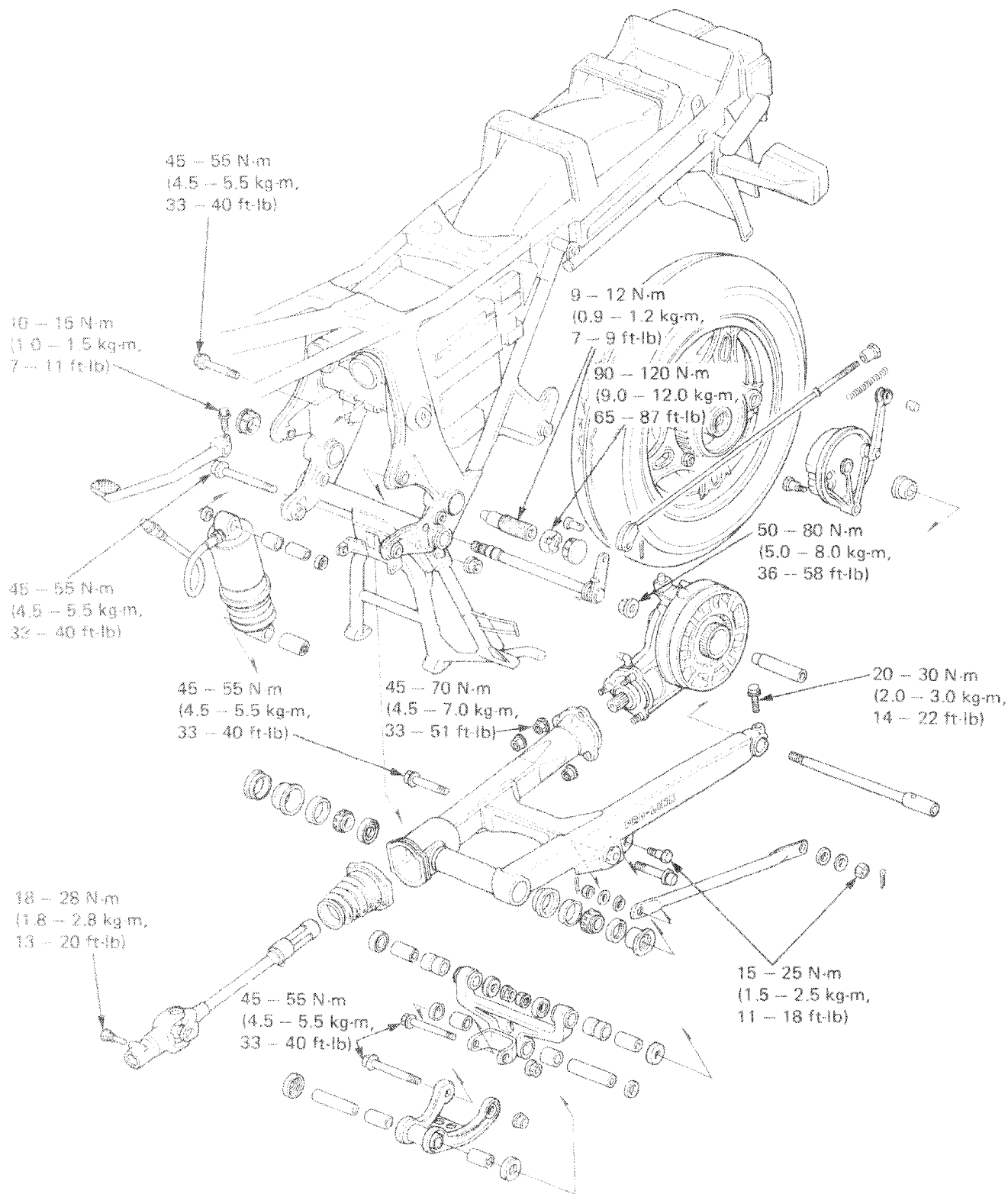



SERVICE INFORMATION	14-1
TROUBLESHOOTING	14-2
REAR WHEEL/REAR BRAKE	14-3
SHOCK ABSORBER	14-10
SWINGARM/DRIVESHAFT	14-16
SUSPENSION LINKAGE	14-25
FINAL DRIVE	14-27

SERVICE INFORMATION

GENERAL INSTRUCTIONS

- COMSTAR® wheels are not serviceable. If either the spokes, rim or hub are damaged the entire wheel must be replaced. Never ride on the spokes.
- Tubeless tire removal, repair and remounting procedures are covered in the Tubeless Tire Manual.
- Before installing the rear wheel, apply MULTIPURPOSE NLGI No. 2 Grease (Molybdenum disulfide additive) to the final driven flange and splines on the final drive shaft.
- Take care not to damage the body when removing and installing the shock absorber.
- Perform the following inspections when reassembling the final gear case.
 - Pinion gear preload
 - Final gear assembly preload
 - Gear backlash
 - Tooth contact

WARNING

- *Brake dust may contain asbestos which can be harmful to your health. Do not use compressed air to clean the brake drum or brake panel. Use a vacuum with a sealed dust collector. Wear a protective face mask and thoroughly wash your hands when finished.*
- *Use only genuine rear suspension linkage and shock absorber pivot/mount bolts. Others may not have adequate strength. Note the installation direction of the bolts.*

TOOLS

Special

Oil seal driver	07965-MA10100
Oil seal driver attachment	07965-MA10200
Pivot lock out wrench	07908-4690001 or KS-HBA-08-469 (U.S.A.)
Needle bearing remover set or Needle bearing remover	07936-8890100
Bearing remover handle	07936-8890300
Bearing remover weight	87936-3710100
Ring gear retainer wrench	07936-3710200
Ring gear dis/assembly tool set or Dis/assembly tool	07910-3710000
Ring gear center guide	07965-4150001
Seal driver attachment or Driver	07965-3710100
Oil seal guide	07945-4150200
O-ring guide	07945-3710200
Pinion gear retainer wrench	07973-MA10100
	07973-MA10200
	07910-MA10100 or
	07910-4150000
Preload inspection tool	07998-4150000
Pinion gear puller attachment	07934-MA10100
Pinion gear catcher	07934-MA10200

Common

Retainer wrench B	07710-0010200
Retainer wrench body	07710-0010401
Attachment 42 x 47 mm	07746-0010300
Pilot 15 mm	07746-0040300
* Pin driver 3.5 m	07744-0010300
Attachment 37 x 40 mm	07746-0010200
Bearing driver handle A	07749-0010000
* Extension	07716-0020500
Pilot 30 mm	07746-0040700
Bearing driver attachment 52 x 55 mm	07746-0010400
Socket bit 17 mm	07703-0020500

* equivalent tools commercially available in U.S.A.



TORQUE VALUES

Shock absorber mount bolts	45–55 N·m (4.0–5.5 kg-m, 33–40 ft-lb)
Suspension linkage pivot bolt	45–55 N·m (4.0–5.5 kg-m, 33–40 ft-lb)
Rear axle nut	50–80 N·m (5.0–8.0 kg-m, 36–58 ft-lb)
Rear axle pinch bolt	20–30 N·m (2.0–3.0 kg-m, 14–22 ft-lb)
Swingarm pivot bolt	9–12 N·m (0.9–1.2 kg-m, 7–9 ft-lb)
Swingarm pivot lock nut	90–120 N·m (9.0–12.0 kg-m, 65–87 ft-lb)
Final gear case nut	45–70 N·m (4.5–7.0 kg-m, 33–51 ft-lb)
Drive shaft lock nut	18–28 N·m (1.8–2.8 kg-m, 13–20 ft-lb)
Brake stopper arm bolt/nut	15–25 N·m (1.5–2.5 kg-m, 11–18 ft-lb)
Rear brake pedal bolt	10–15 N·m (1.0–1.5 kg-m, 7–11 ft-lb)

SPECIFICATIONS

ITEM		STANDARD	SERVICE LIMIT
Axle bend		_____	0.2 mm (0.008 in)
Rear wheel runout	Radial	_____	2.0 mm (0.08 in)
	Axial	_____	2.0 mm (0.08 in)
Brake lining thickness		4.9–5.0 mm (0.19–0.20 in)	2.0 mm (0.08 in)
Rear brake drum I.D.		160.0 mm (8.06 in)	161 mm (6.34 in)
Final drive	Backlash	0.08–0.18 mm (0.003–0.077 in)	0.25 mm (0.010 in)
	Backlash difference	_____	0.10 mm (0.004 in)
	Pinion gear preload	0.4–0.5 N·m (4.0–5.0 kg-cm, 3.48–4.32 in-lb)	_____
	Assembly preload	0.6–0.9 N·m (6.0–9.0 kg-cm, 5.16–7.80 in-lb)	_____
Final gear oil capacity		160–180 cc (5.4–6.1 oz)	_____
Rear shock absorber oil capacity		669 cc (22.6 oz)	_____
Rear shock absorber air pressure	GL500	0 – 500 kPa (0–5.0 kg/cm ² , 0–70 psi)	_____
	GL500I	100–500 kPa (1.0–5.0 kg/cm ² , 14–70 psi)	_____

TROUBLESHOOTING

Wobble or Vibration

1. Distorted rim
2. Loose wheel bearing
3. Loose or distorted spokes
4. Faulty tire
5. Loose axle

Soft Suspension

1. Weak spring
2. Shock absorber improperly adjusted
3. Weak rear damper

Hard Suspension

1. Shock absorber improperly adjusted

Suspension Noise

1. Shock case binding
2. Loose fasteners

Poor Brake Performance

1. Improper brake adjustment
2. Fouled brake linings
3. Worn brake shoes
4. Worn brake shoe cam contacting faces
5. Worn brake drum
6. Improper engagement between brake arm and shaft serrations

Final drive gear noise

1. Oil level too low
2. Excessive backlash
3. Drive shaft splines damaged or worn
4. Insufficient lubricant



REAR WHEEL/BRAKE

REAR WHEEL REMOVAL

Place the motorcycle on its center stand.
Loosen the axle nut.

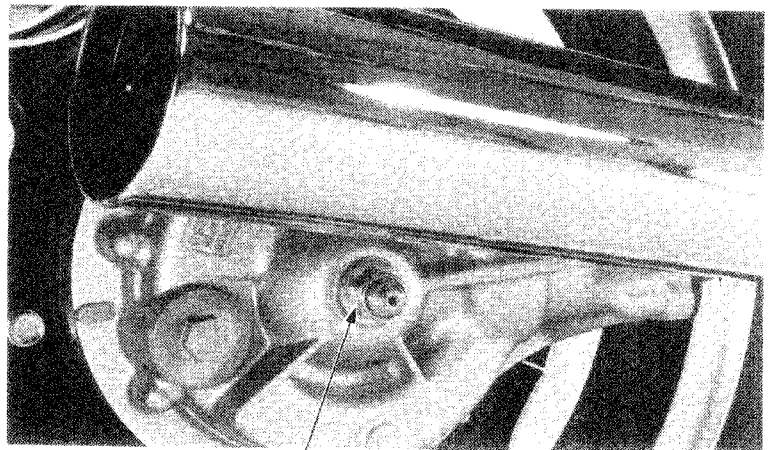

AXLE NUT

Remove the axle pinch bolt.
Remove the cotter pin and remove the brake stopper arm from the brake panel.
Remove the brake adjusting nut and the brake rod.
Remove the rear axle.

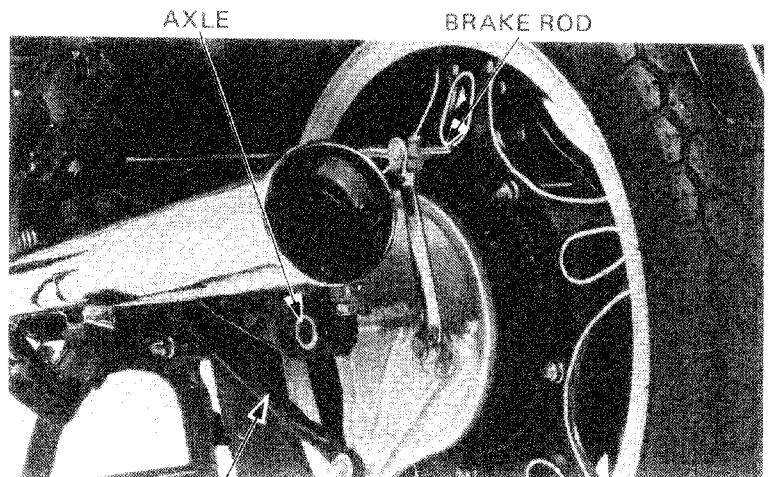

AXLE

BRAKE ROD

STOPPER ARM

Remove the seat.
Remove the two 6 mm bolts and pull the rear fender up.

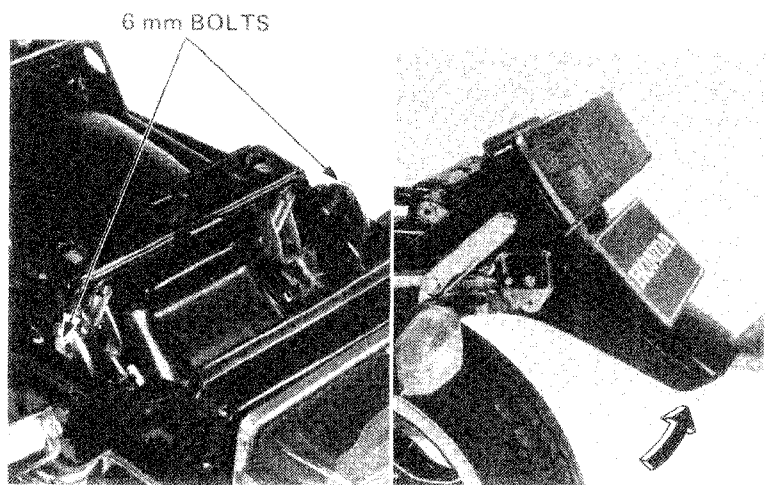

6 mm BOLTS



Push the rear wheel toward the left away from the final drive gear and then remove the wheel with the brake panel by pulling it backward.

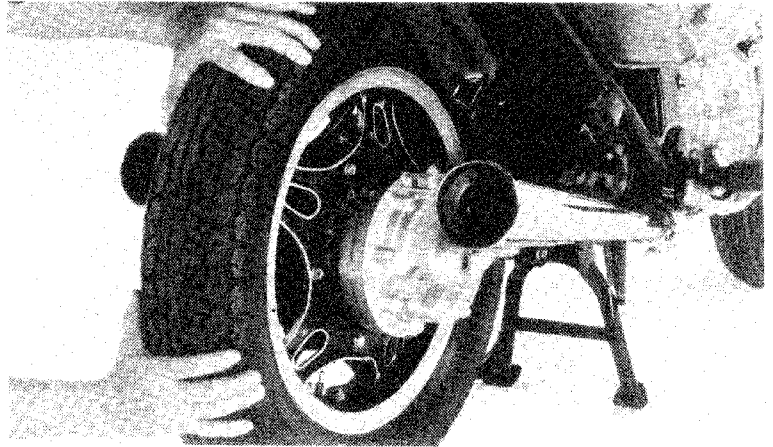

AXLE INSPECTION

Set the axle shaft in V-blocks and measure the run-out. The actual runout is 1/2 of the total indicator reading.

SERVICE LIMIT: 0.20 mm (0.008 in.)

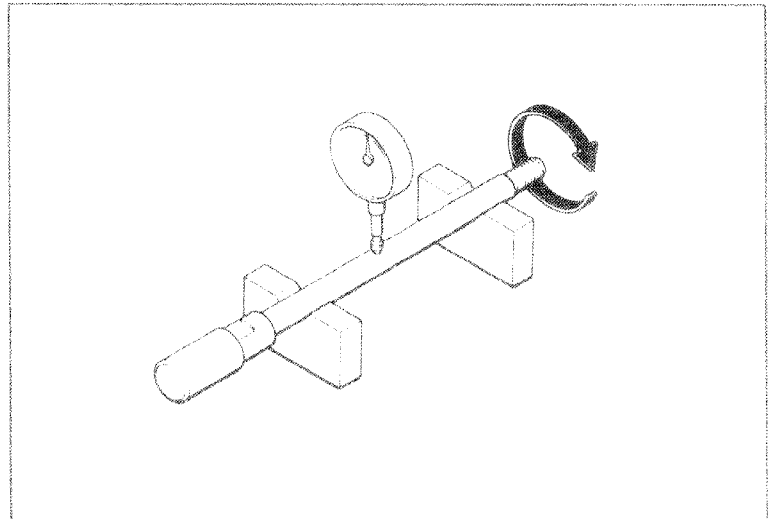

REAR WHEEL BEARING INSPECTION

Rotate the rear wheel bearing by hand.
Replace the wheel bearings with new ones if they are noisy or have excessive play.

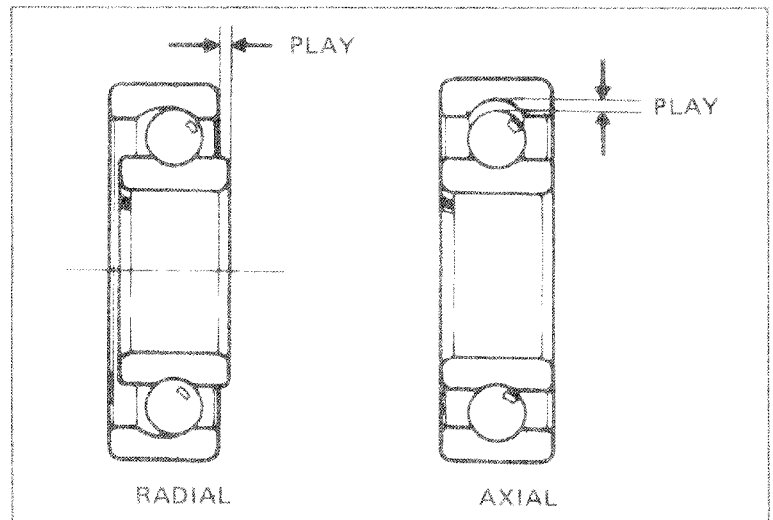



**REAR WHEEL RIM RUNOUT INSPEC-
TION**

Place the wheel in a truing stand. Spin the wheel slowly and measure the runout with a dial indicator.

SERVICE LIMITS:

RADIAL RUNOUT: 2.0 mm (0.08 in)

AXIAL RUNOUT: 2.0 mm (0.08 in)

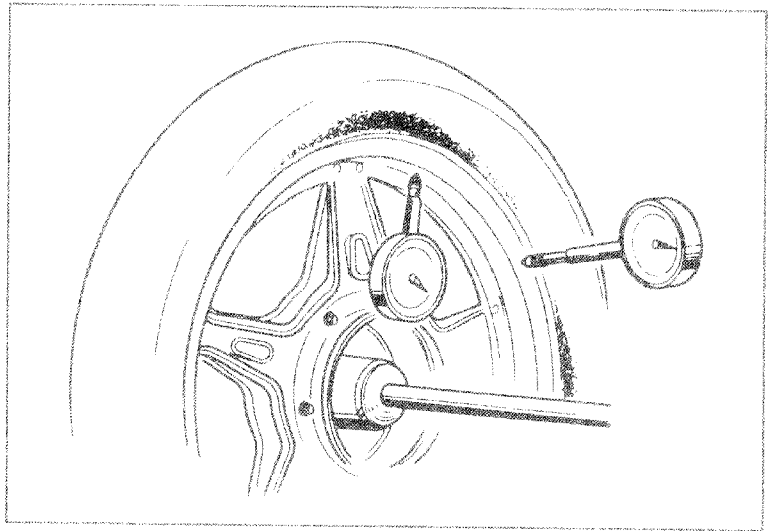

**BRAKE LINING THICKNESS INSPEC-
TION**

Measure the brake lining thickness.

SERVICE LIMIT: 2.0 mm (0.08 in)

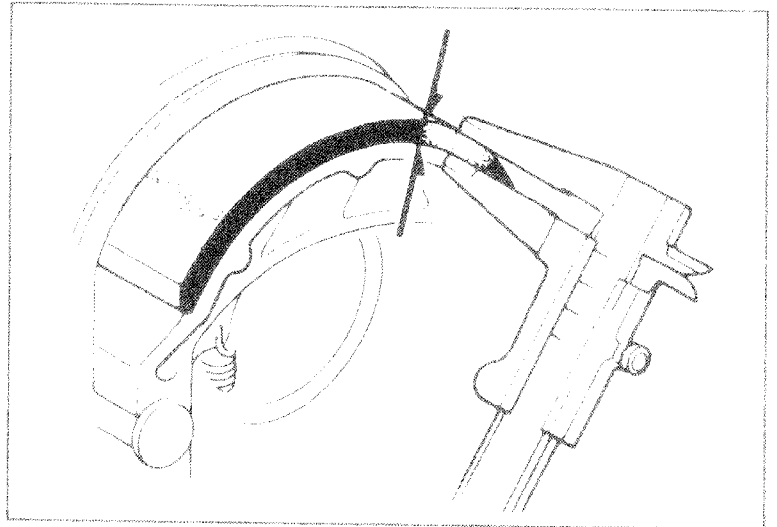

BRAKE DRUM I.D. INSPECTION

Measure the brake drum inside diameter.

SERVICE LIMIT: 161 mm (6.34 in)

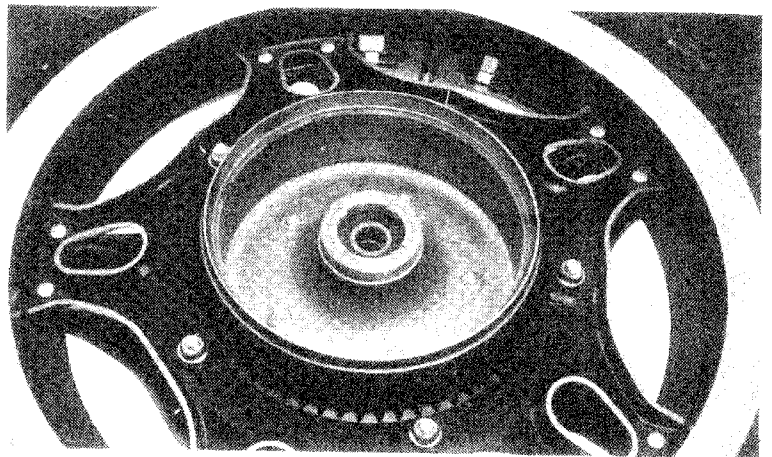

BRAKE SHOE REPLACEMENT

- Remove the brake arm.
- Remove the cotter pins.
- Remove the brake shoes and springs.

WARNING
Keep grease off the brake linings. Wipe excess grease off the cam and anchor pins. If grease gets on the brake linings the stopping power will be reduced.

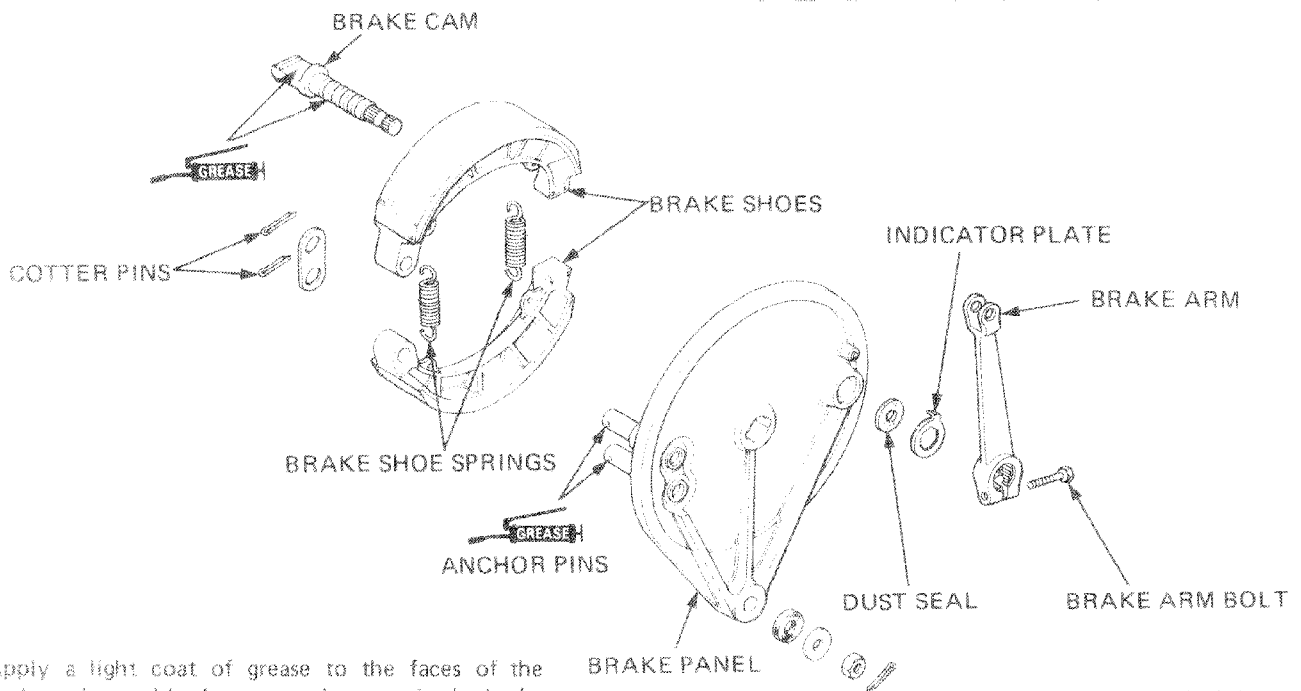
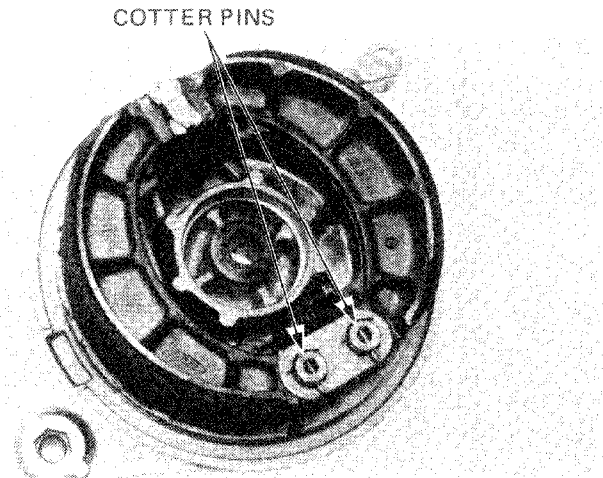

Apply a light coat of grease to the faces of the anchor pins and brake cam and groove in the brake cam.

- Install the dust seat.
- Install the wear indicator plate.

NOTE
Align the indicator plate tab with the brake cam cut-out.

Install the brake arm on the brake cam.

NOTE
Align the punch marks.

Tighten the brake arm bolt.
TORQUE: 10–14 N·m (1.0–1.4 kg·m, 7–10 ft·lb)

- Install the brake shoes and spring.
- Install new cotter pins.

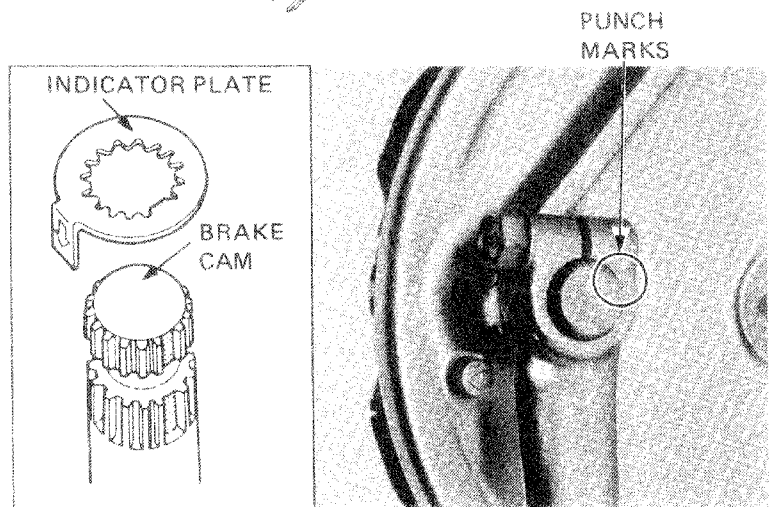



REAR WHEEL DISASSEMBLY

Remove the bearing retainer.
Remove the final driven flange.
Remove the bearings and distance collar from the rear wheel hub.

NOTE

If the bearings are removed, replace them with new bearings during assembly.

RETAINER
WRENCH BODY

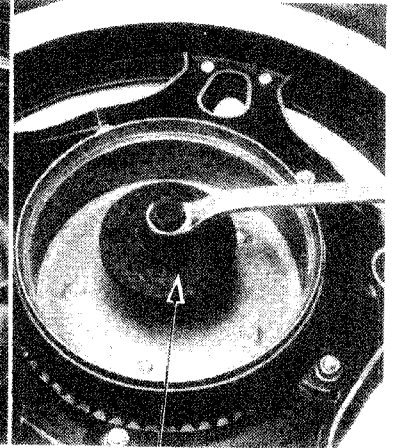
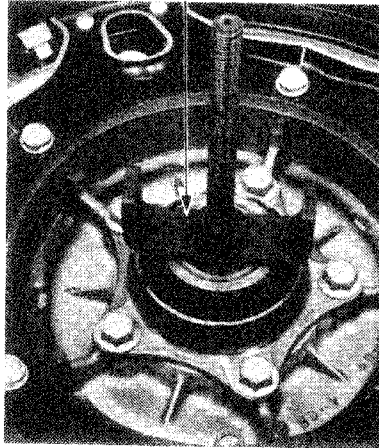

RETAINER WRENCH
ATTACHMENT

REAR WHEEL ASSEMBLY

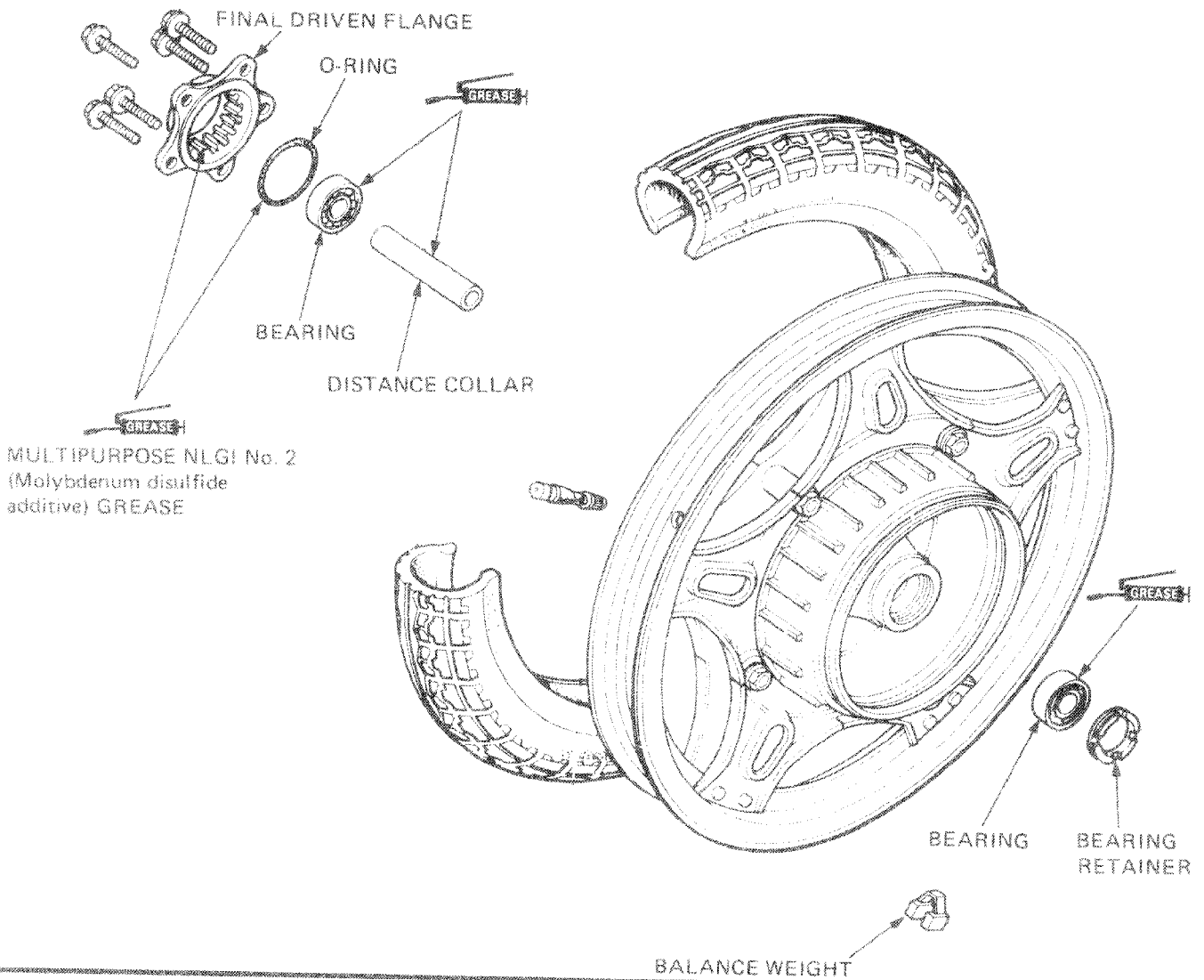

Pack all bearing cavities with grease and drive in the bearing with a bearing driver.
Drive the left (retainer side) bearing first.

CAUTION

Drive the bearings in squarely with the sealed end facing out, making sure they are fully seated.

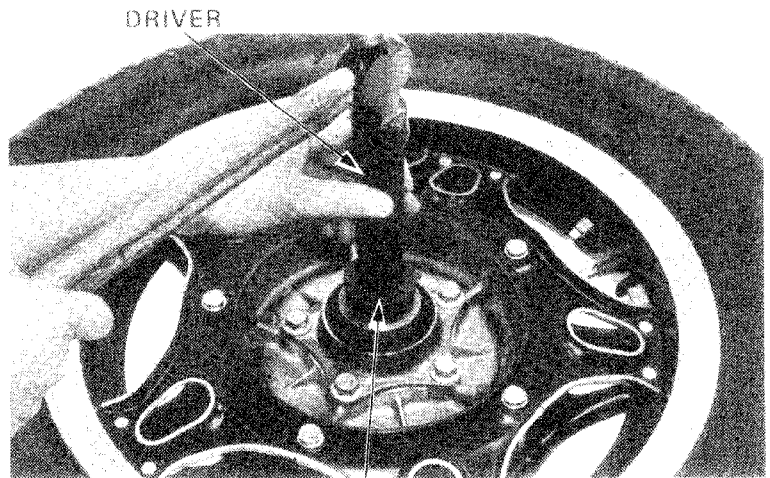

DRIVER
ATTACHMENT 42 x 47 mm
AND PILOT 15 mm

Install the bearing retainer with the retainer wrench.
Peen the retainer to the hub.

NOTE

Check the condition of the bearing retainer.
Replace the retainer if the threads are damaged.

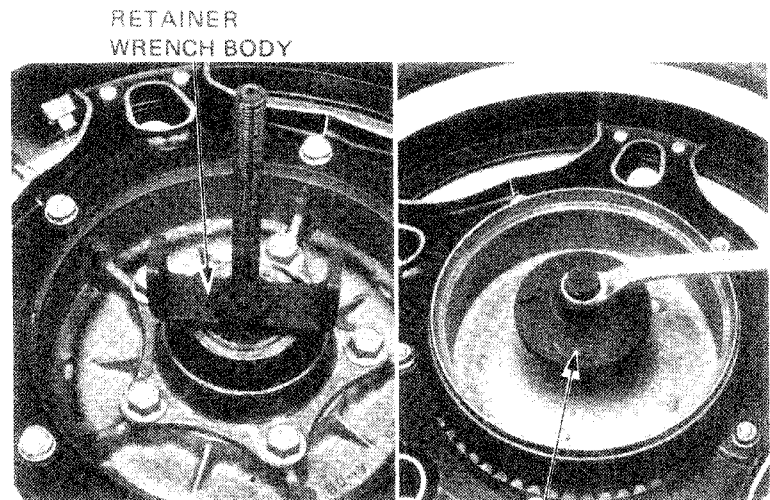

RETAINER
WRENCH BODY

RETAINER WRENCH
SOCKET

Install the O-ring. Lubricate the splines of the final driven flange and the O-ring with lithium-based MULTIPURPOSE NLGI No. 2 (molybdenum disulfide additive) GREASE.

Apply a liquid sealant to the final driven flange and rear wheel hub mating surfaces.

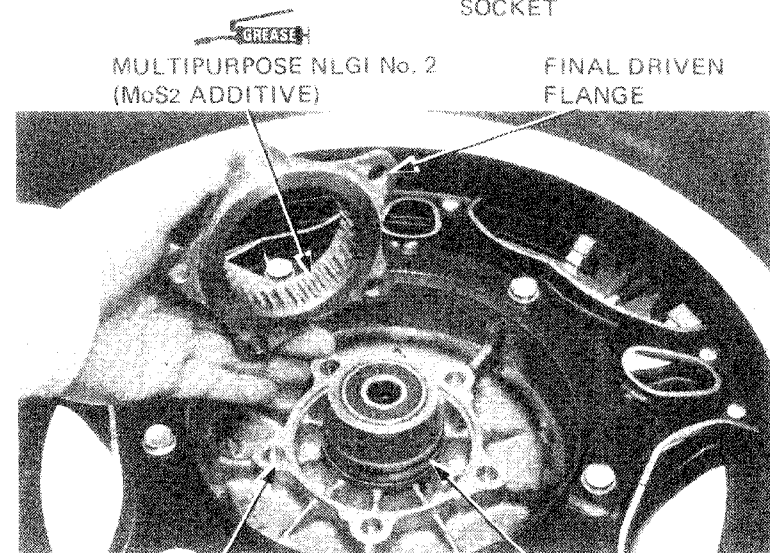

GREASE
MULTIPURPOSE NLGI No. 2
(MoS₂ ADDITIVE)

FINAL DRIVEN
FLANGE

SEALING AGENT

O-RING



Install the final drive flange and torque the bolts.
TORQUE: 40–50 N·m
(4.0–5.0 kg·m, 29–36 ft·lb)

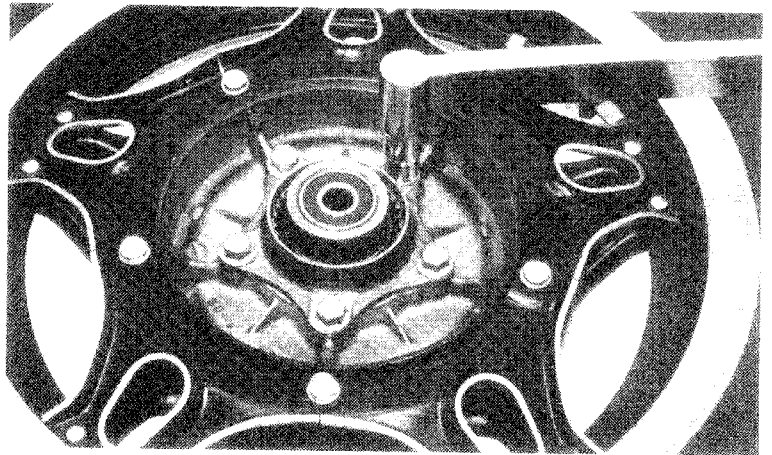

REAR WHEEL INSTALLATION

Apply MULTIPURPOSE NLGI No. 2 (Molybdenum disulfide additive) GREASE to the final driven flange spline of the rear wheel and ring gear.
Insert the distance collar into the final gear case in the direction shown.

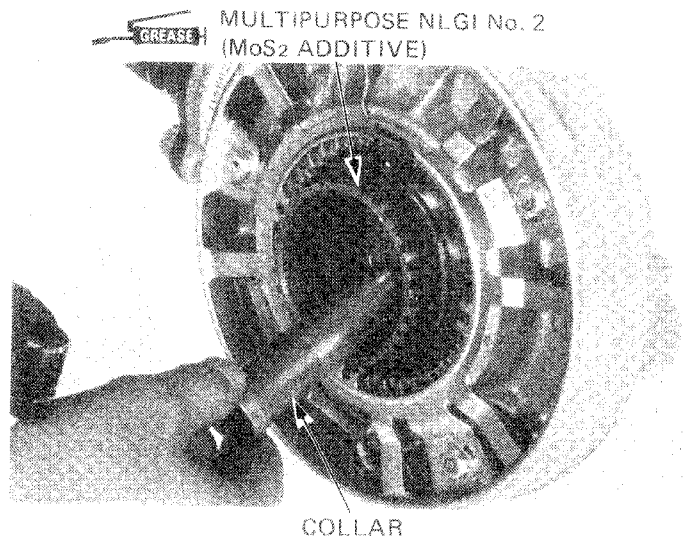

Install the rear wheel and brake panel.
Insert the rear axle through the swingarm, washer, brake panel and rear wheel.

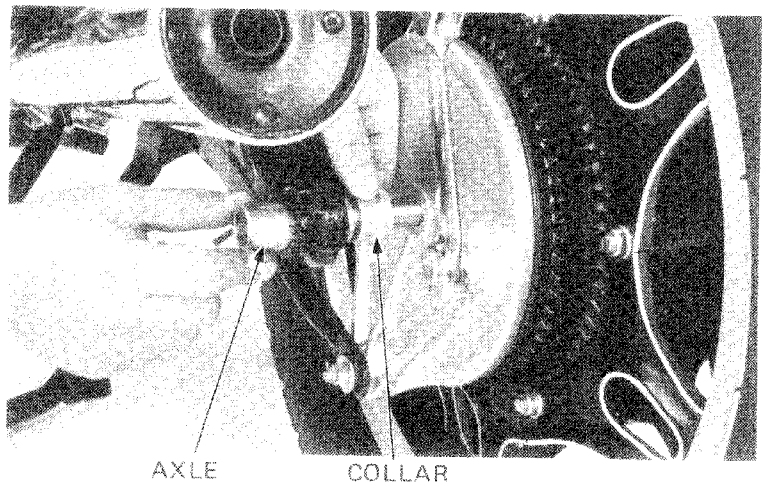

Install the brake torque link and tighten the nut.

TORQUE: 15–25 N·m
(1.5–2.5 kg·m, 11–18 ft·lb)

Install the new cotter pin to the torque link bolt.

Tighten the axle pinch bolt.

TORQUE: 50–80 N·m
(5.0–8.0 kg·m, 36–58 ft·lb)

Tighten the axle pinch bolt.

TORQUE: 20–30 N·m
(2.0–3.0 kg·m, 14–22 ft·lb)

Connect the brake rod and adjust rear brake pedal free play (Page 3-13).

AXLE PINCH BOLT BRAKE ROD

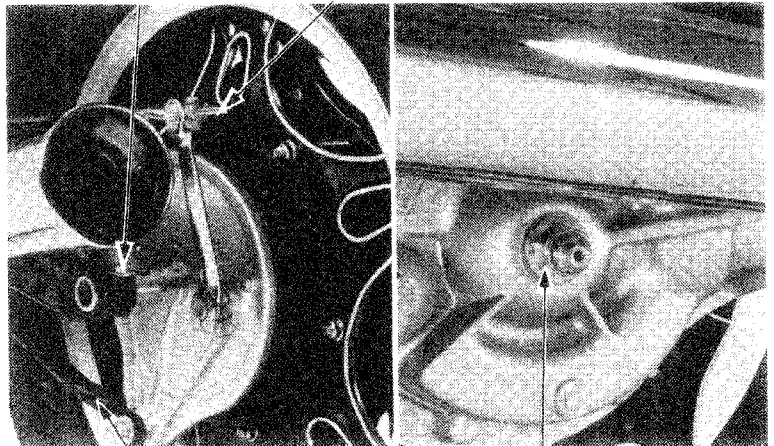

TORQUE LINK

AXLE NUT

Tighten the rear fender bolts and install the seat.

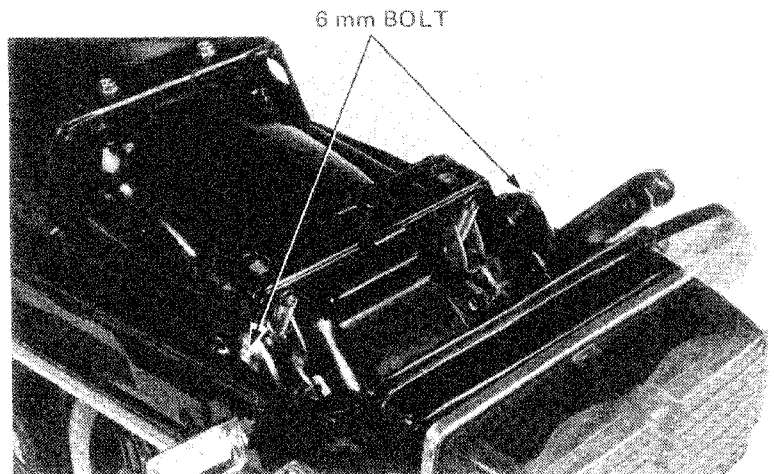

6 mm BOLT

SHOCK ABSORBER

REMOVAL

NOTE

The shock absorber can be removed without removing the air cleaner case.

Place the motorcycle on the center stand.
Remove the muffler.
Remove the shock absorber lower mount bolt.
Remove the shock arm and shock link (Page 14-25).

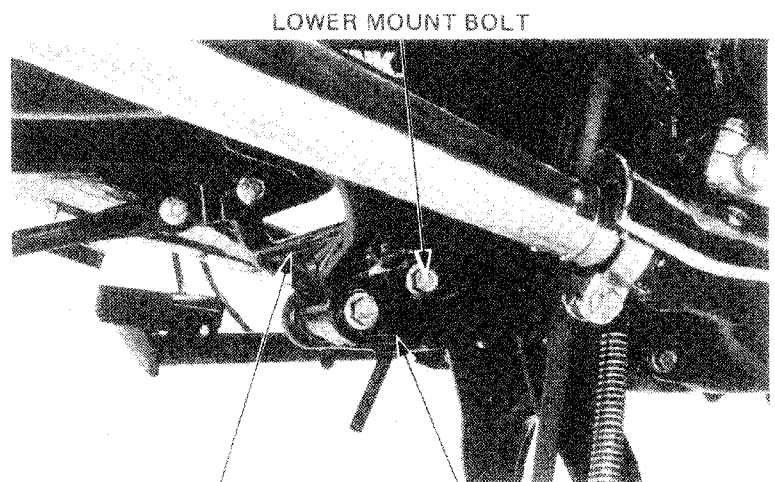

LOWER MOUNT BOLT

SHOCK ARM

SHOCK LINK



Disconnect the air hose from the hose clamp.
Remove the shock absorber upper mount bolt.

NOTE

Hold the shock absorber to prevent it from falling.

Remove the shock absorber.

UPPER MOUNT BOLT

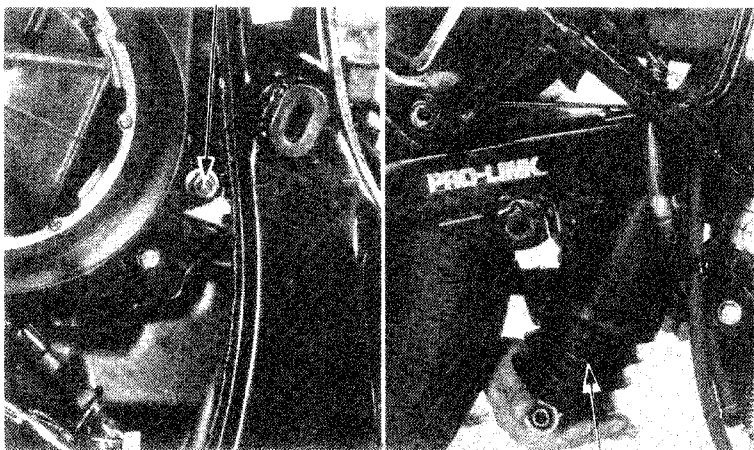

SHOCK ABSORBER

OIL SEAL REPLACEMENT

Remove the boot band and boot.
Remove the circlip and back-up plate.

CIRCLIP

BACK-UP PLATE

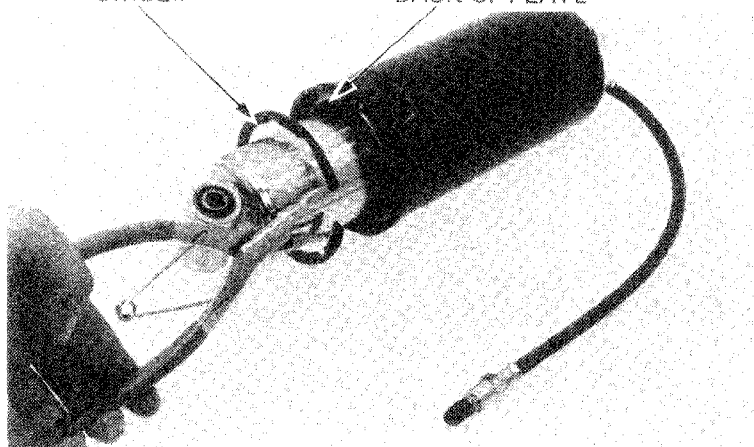

Release air pressure and remove the air valve from the hose.

AIR VALVE

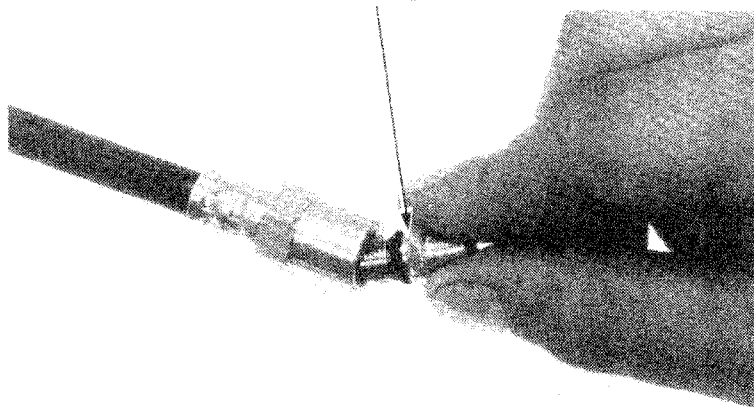

REAR WHEEL/BRAKE/FINAL DRIVE/ SUSPENSION

Place about 300 cc (10.1 oz) of damper oil (ATF or equivalent) in a clean container.
Place the shock absorber in a hydraulic press using an Oil Seal Driver Attachment positioned as shown.
Place the air hose in the oil and press the shock absorber several times until the damper is filled with the oil.

NOTE

Do not over-press the shock.
This shock absorber's stroke is 47 mm
(1.85 in).

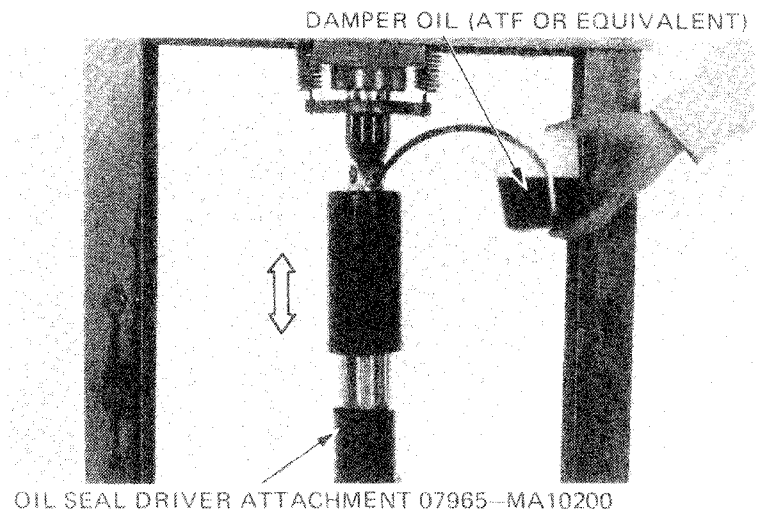

Remove the shock from the press.
Reinstall the air valve in the air hose.
Place the Oil Seal Driver on the oil seal.
Place the shock absorber in the hydraulic press using the Oil Seal Driver Attachment.
Press the oil seal out by compressing the shock absorber.

CAUTION

Spill as little ATF as possible to prevent air from entering the shock. Air in the shock will cause the damping to be too soft.

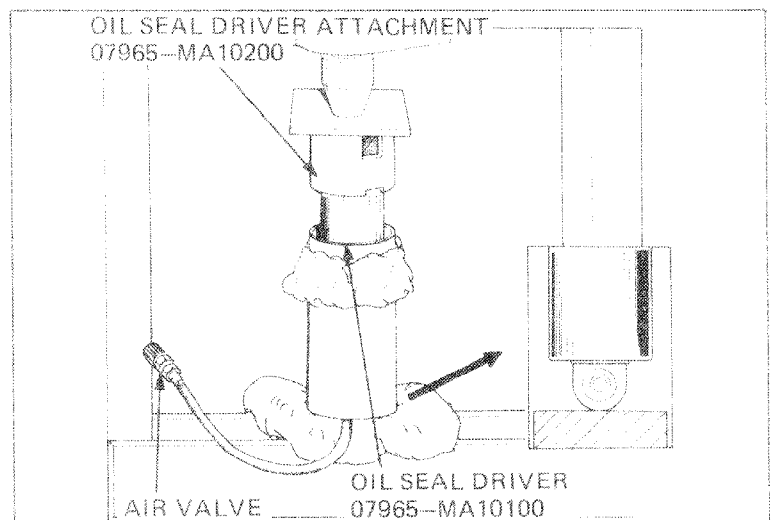



SHOCK ABSORBER ASSEMBLY

NOTE

Apply MULTIPURPOSE NLGI No. 2 (molybdenum disulfide additive) GREASE to the upper mount bushings.

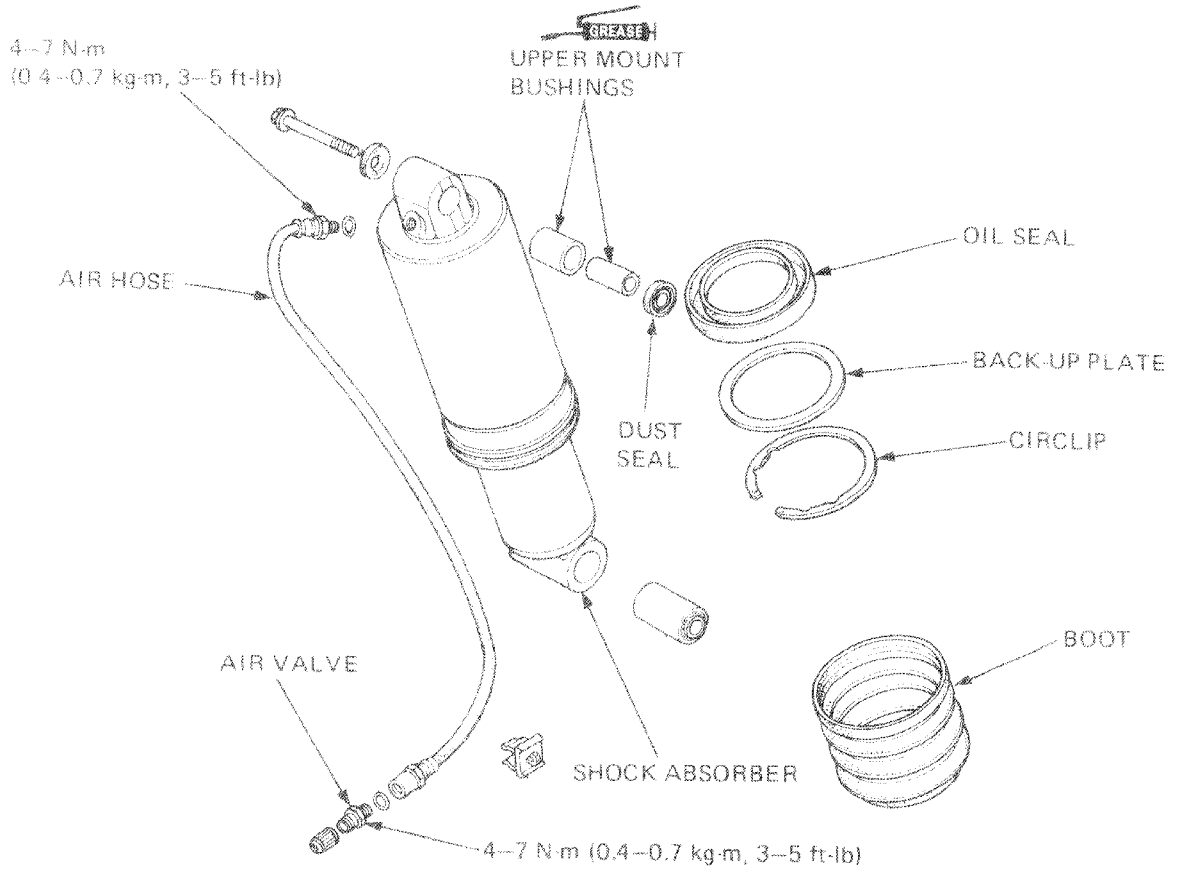

Fill the shock absorber with damper oil (ATF or equivalent).

Wrap a piece of tape around the groove at the end of the shock absorber.

Dip the oil seal in damper oil and install it on the damper.

CAUTION

Be careful not to damage the oil seal during installation.

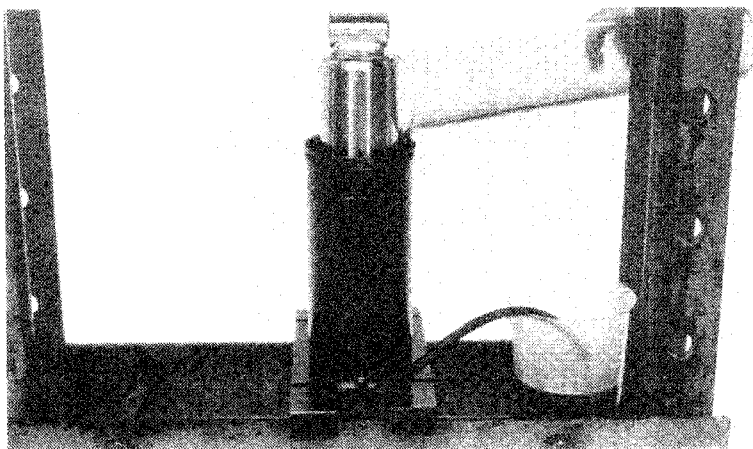

Remove the air valve from the air hose.

Press the oil seal in the shock absorber with a hydraulic press until the oil seal driver stops at the edge of the outer case.

OIL SEAL DRIVER ATTACHMENT
07965-MA10200

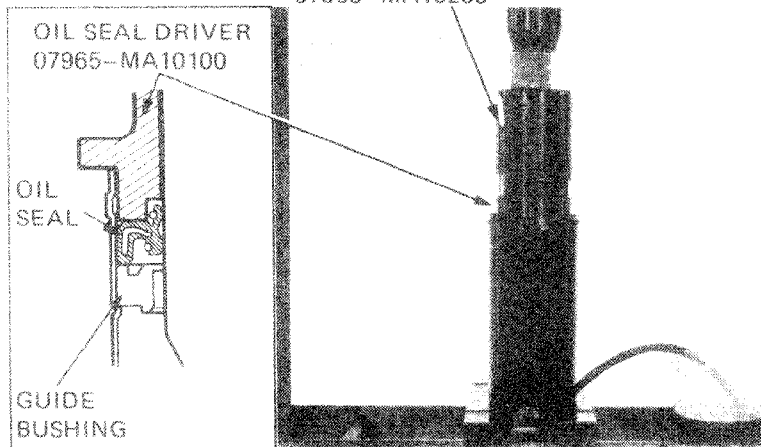

Install the back-up plate.

Install the circlip with the radiused edge facing down.

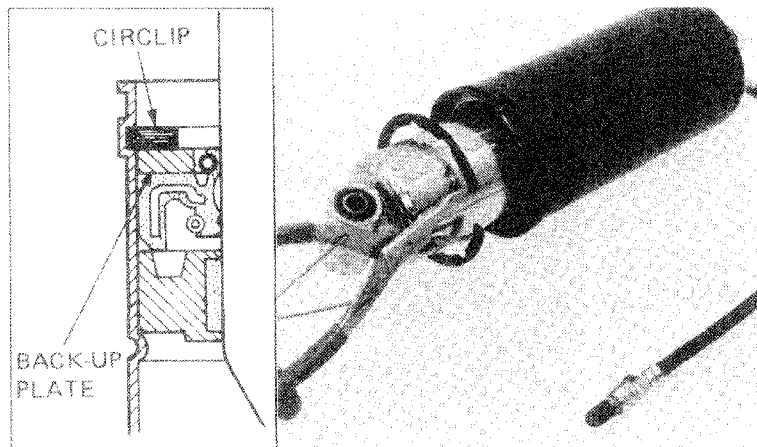



Fill the shock absorber with damper oil (Page 14-12).

CAUTION

Make sure that the damper is completely empty of air

Drain the damper oil to specified capacity by compressing the shock absorber slowly.

SPECIFIED CAPACITY: 200 cc (6.76 oz)

Remove the shock absorber from the hydraulic press and install the air valve.
Install the boot and boot clip.

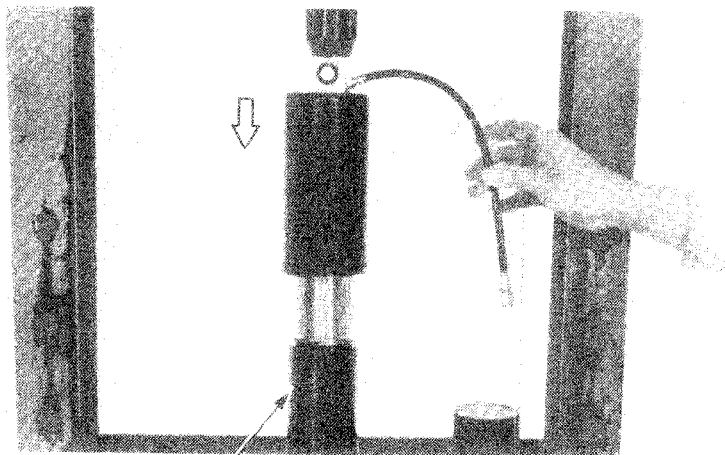

OIL SEAL DRIVER ATTACHMENT
07965-MA10200

Apply molybdenum paste grease to the upper mount bushings.

NOTE

- * Use paste grease (containing more than 45% of molybdenum) as follows:
* MOLYKOTE® G PASTE or G-n PASTE
 manufactured by Dow Corning U.S.A.
* Other lubricants of equivalent quality.
- * Do not damage the shock absorber body.

Install and tighten the upper mount bolt.

TORQUE: 45-55 N·m
(4.5-5.5 kg·m, 33-40 ft·lb)

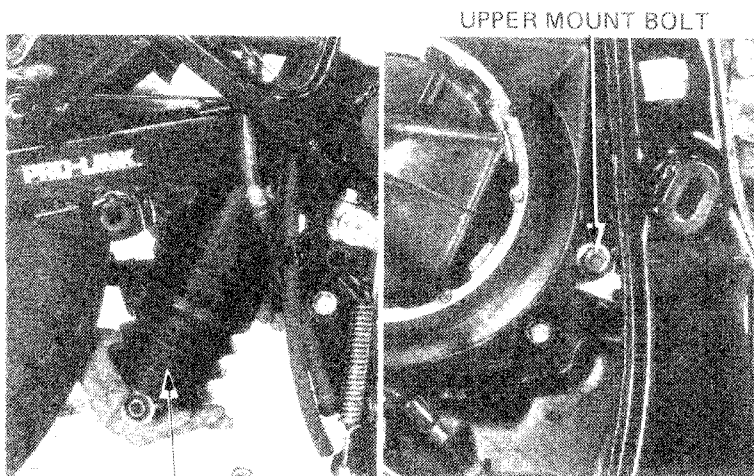

SHOCK ABSORBER

UPPER MOUNT BOLT

Lubricate the linkage pivots with paste grease.
Install the shock arm and shock link (Page 14-26, 14-27).

Tighten the lower mount bolt.

TORQUE: 45-55 N·m
(4.5-5.5 kg·m, 33-40 ft·lb)

Install the muffler.

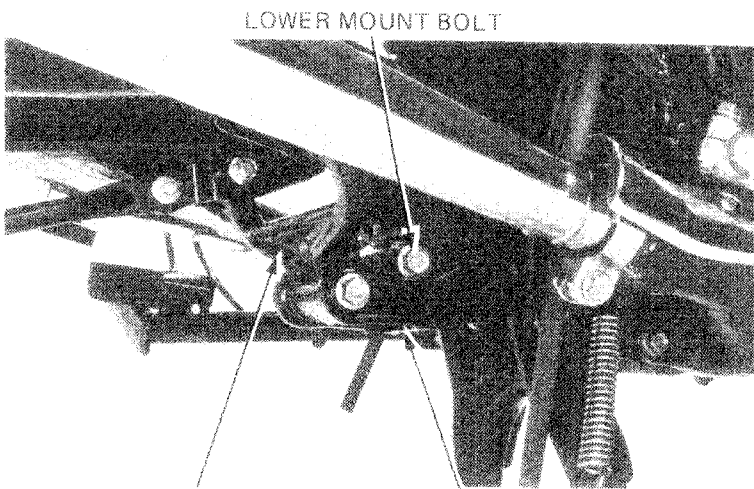

SHOCK ARM

SHOCK LINK

LOWER MOUNT BOLT

Make sure all weight is off the rear wheel, and charge the shock absorber with air.

RECOMMENDED PRESSURE:

STANDARD MODEL:

0--500 kPa (0--5.0 kg/cm², 0--70 psi)

INTERSTATE MODEL:

100--500 kPa (1.0--5.0 kg/cm², 14--70 psi)

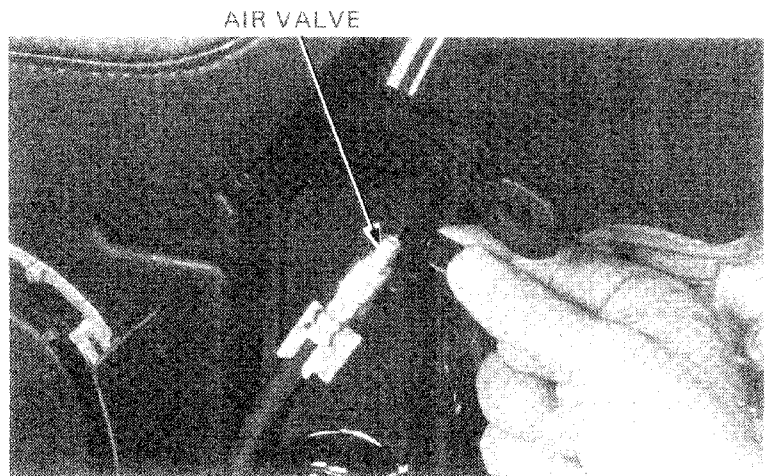

SWINGARM/DRIVE SHAFT

REMOVAL

- Remove the shock absorber (Page 14-10).
- Remove the rear wheel (Page 14-3).
- Remove the final gear case (Page 14-27).

CAUTION

Pump grease into the final gear case through the grease nipple whenever the drive shaft is removed from the engine.

FINAL GEAR CASE

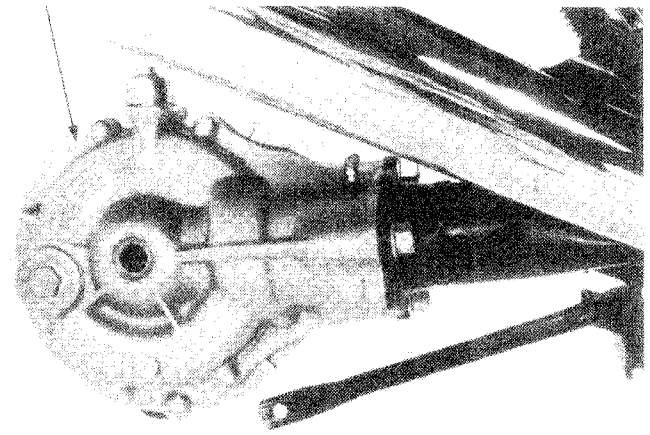

Slide the boot forward and remove the drive shaft lock bolt.

DRIVE SHAFT LOCK BOLT

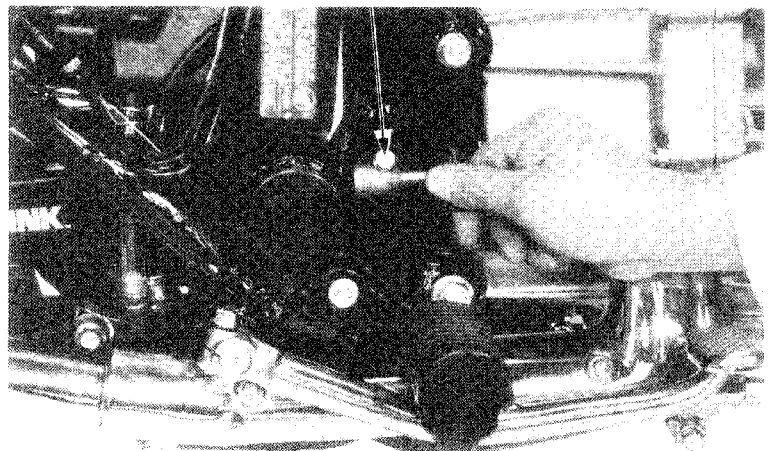



Remove the swingarm pivot lock nut and bolt.

SWINGARM LOCK NUT WRENCH
07908-469001 or KS-HBA-08-469 (U.S.A)

PIVOT BOLT

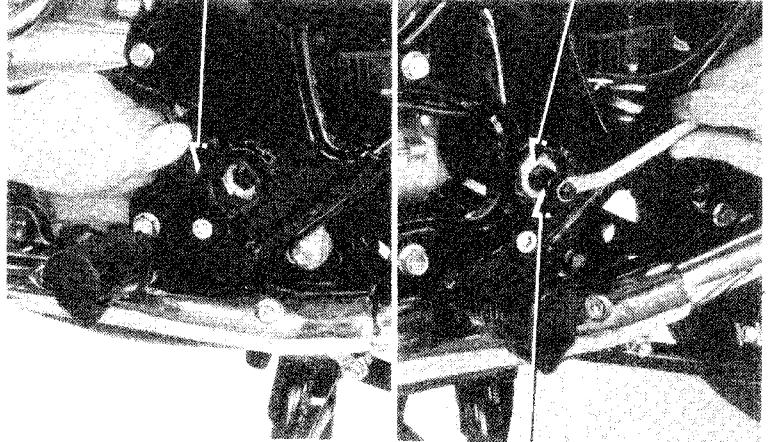

SOCKET BIT 17 mm

Remove the rear brake pedal.

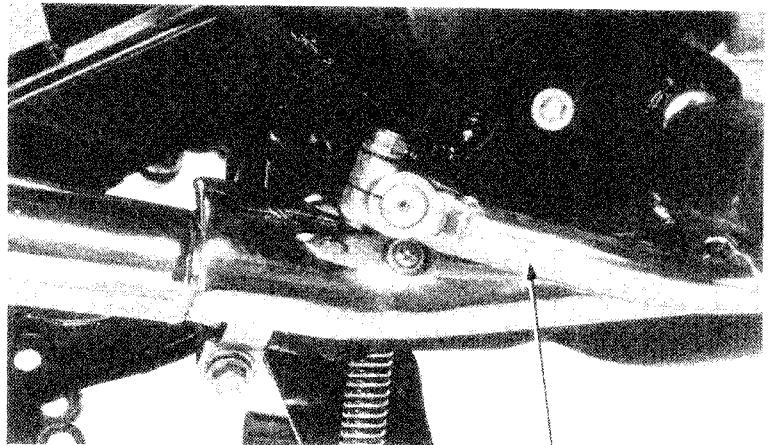

REAR BRAKE PEDAL

Remove the swingarm.

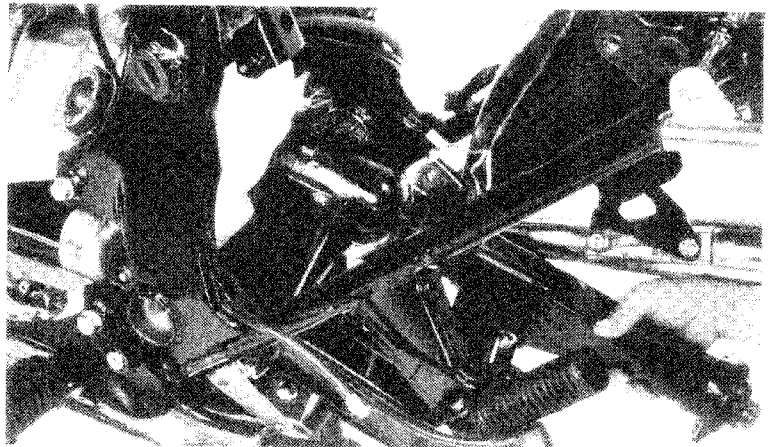

DRIVE SHAFT INSPECTION

Remove the drive shaft from the swingarm.

Inspect the drive shaft and drive shaft joint splines for wear and damage.

Inspect the universal joint. There should be no play in the bearings.

Rotate the shaft and joint in opposite directions. If there is any evidence of side play, the shaft must be replaced.

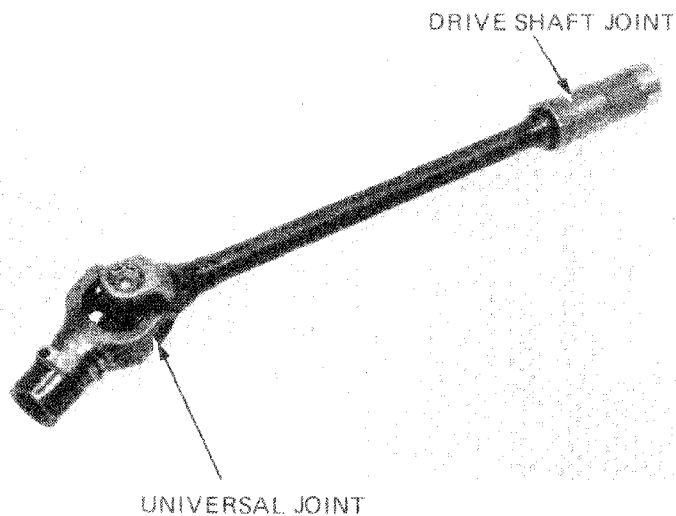

Drive out the spring pin.

Separate the drive shaft joint from the drive shaft.

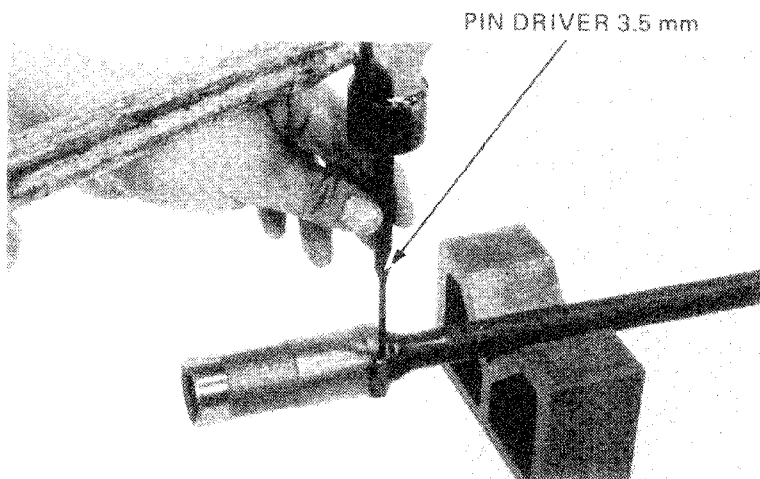

Lubricate the splines with MULTIPURPOSE NLGI No. 2 (molybdenum disulfide additive) GREASE.

Assemble the drive shaft and drive shaft joint and drive in the spring pin.

NOTE

The spring pin should be below the drive shaft joint.

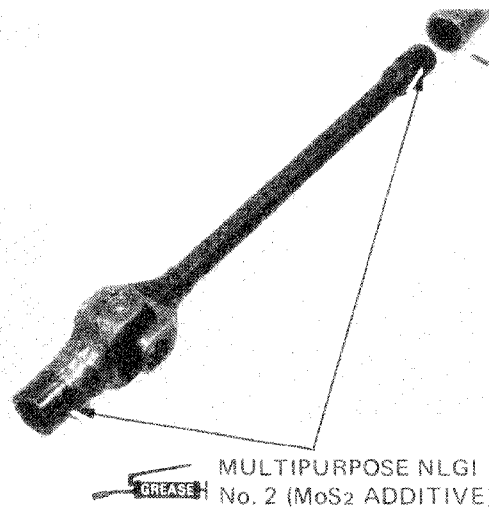



PIVOT BEARING REPLACEMENT

Inspect the tapered roller bearings and races for damage and wear.
If bearing replacement is required, remove the outer races from the swingarm.

NOTE

Always replace pivot bearings in pairs.

Remove the left pivot bearing dust seal and inner bearing.

Remove the outer race with the bearing remover.
Remove the right pivot bearing and dust seal.

Remove the cap and drive the pivot bearing holder out.

CAUTION

Lightly tap the holder with a hammer.

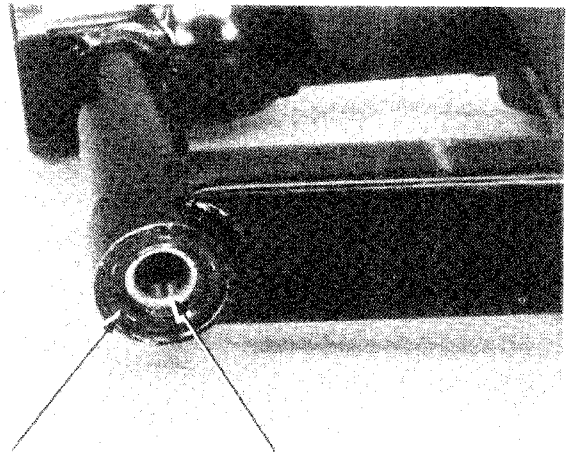

DUST SEAL BEARING

BEARING REMOVER HANDLE 07936-3710100

BEARING REMOVER
07936-8890300

DUST SEAL

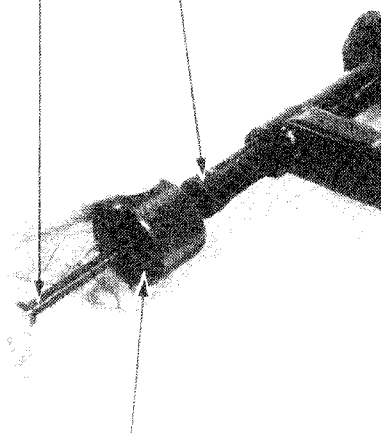

BEARING REMOVER WEIGHT
07936-3710200

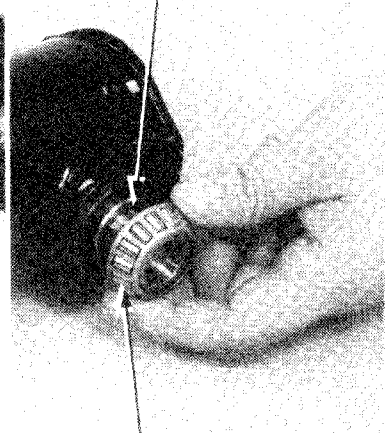

BEARING

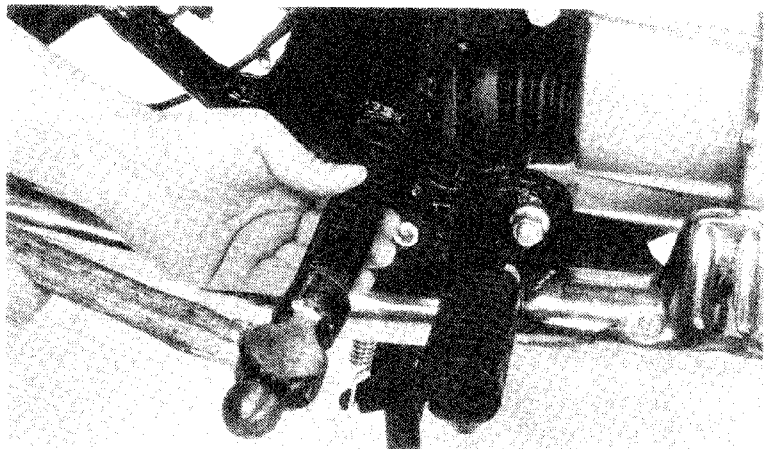

Pack all bearing cavities with grease and grease the oil seal lip.

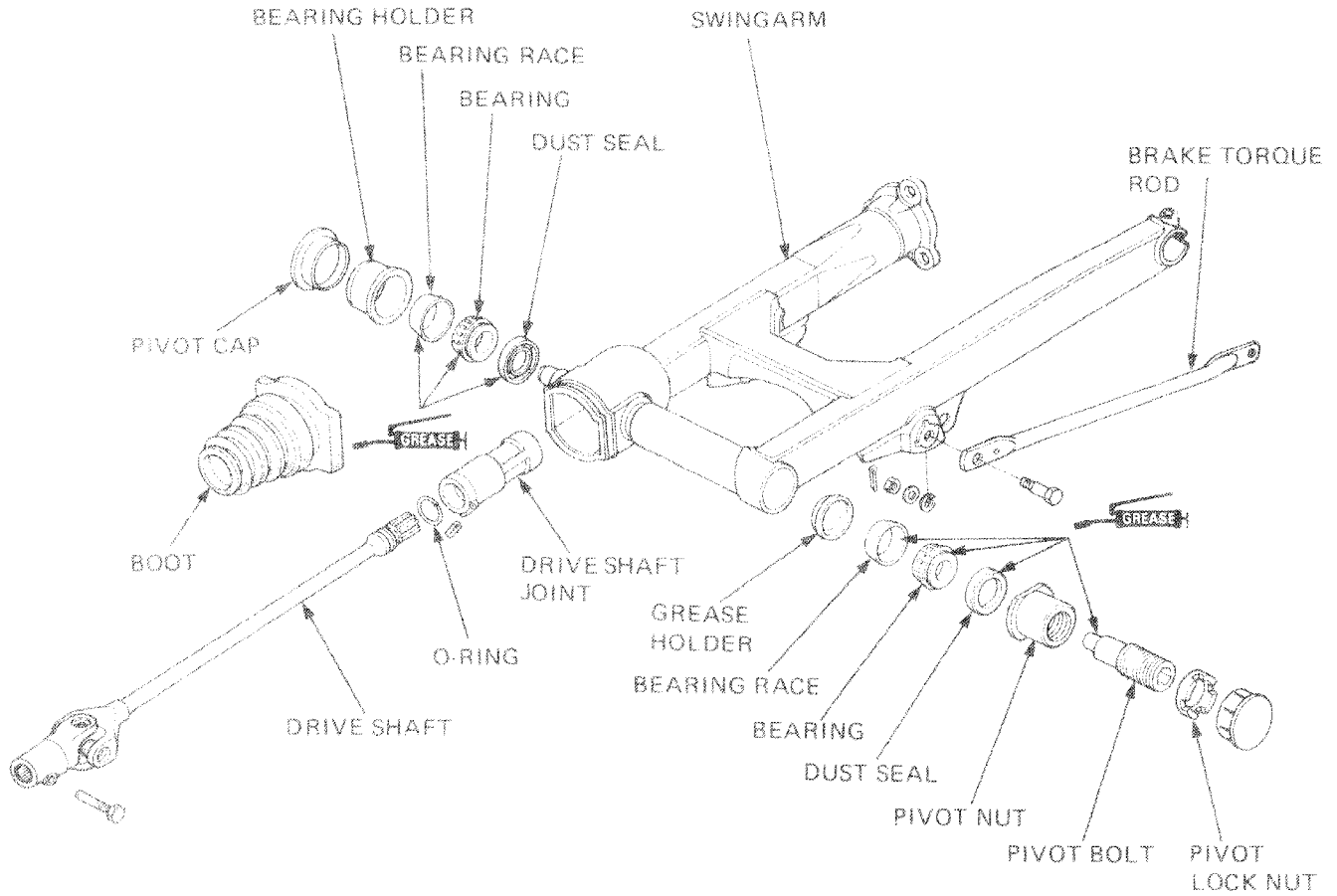

Drive the new bearing race squarely into the bearing holder.

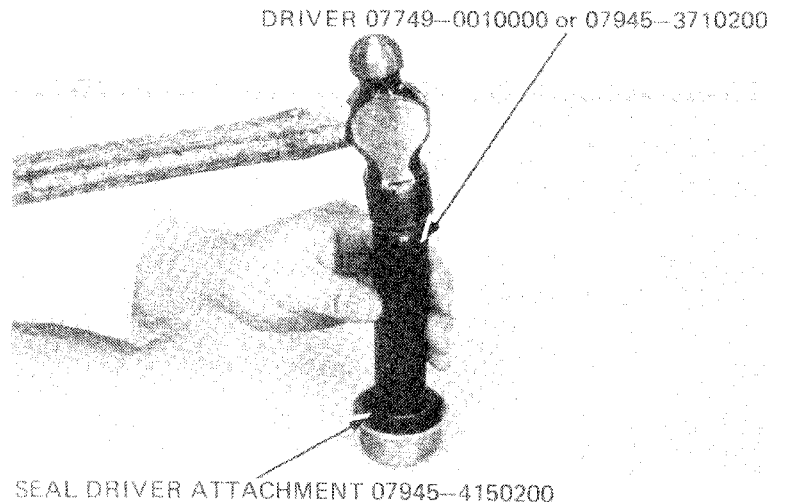



Install the bearing holder so that the flange is seated against the frame body.

BEARING HOLDER

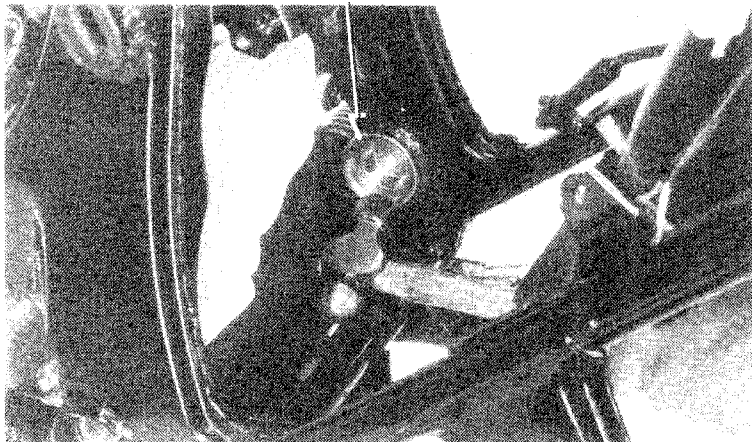

Install the dust seal and bearing into the swingarm.

NOTE

Note the installation direction of the dust seal.

DUST SEAL

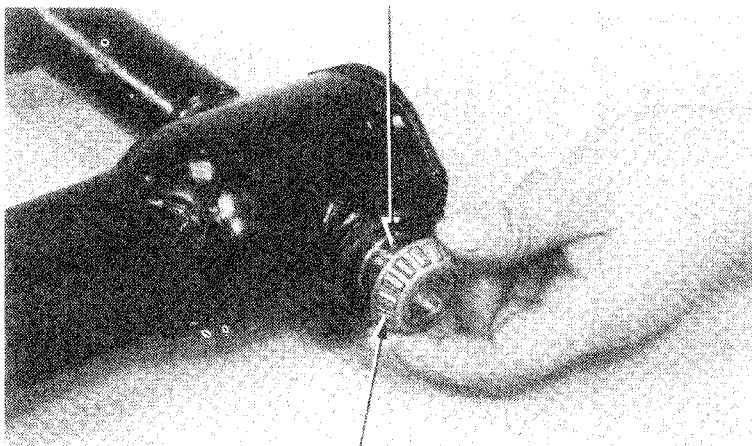

BEARING

Drive the new bearing race into the swingarm.

DRIVER 07749-0010000 or 07945-3710200

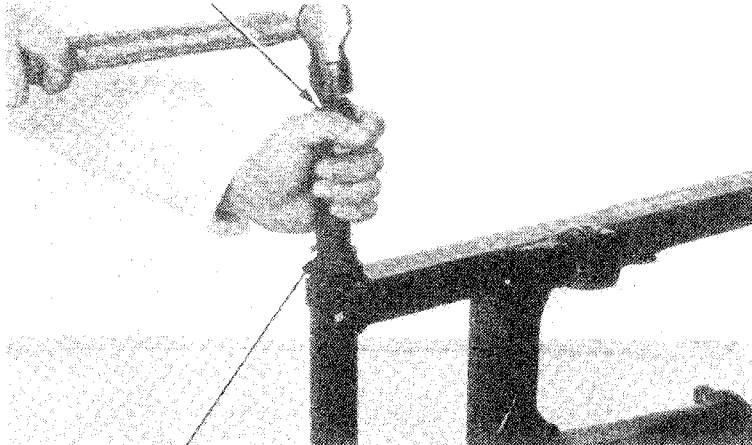

SEAL DRIVER ATTACHMENT 07945-4150200

Install the bearing and dust seal into the swingarm.

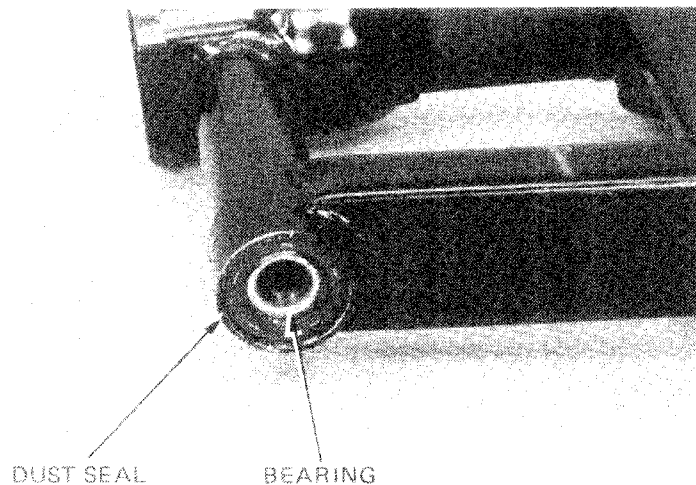

Install the pivot nut if removed.

NOTE

Align the tab of the pivot nut with the slot in the frame.

PIVOT NUT

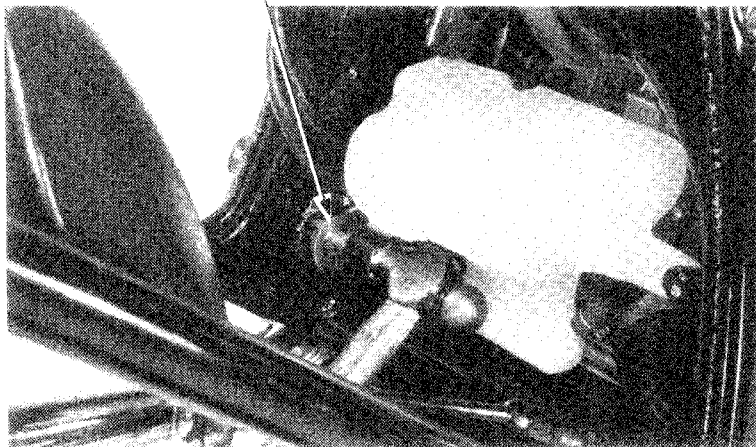

SWINGARM INSTALLATION

Install the drive shaft into the swingarm.
Install the swingarm on the pivot bearing holder
from the right side.

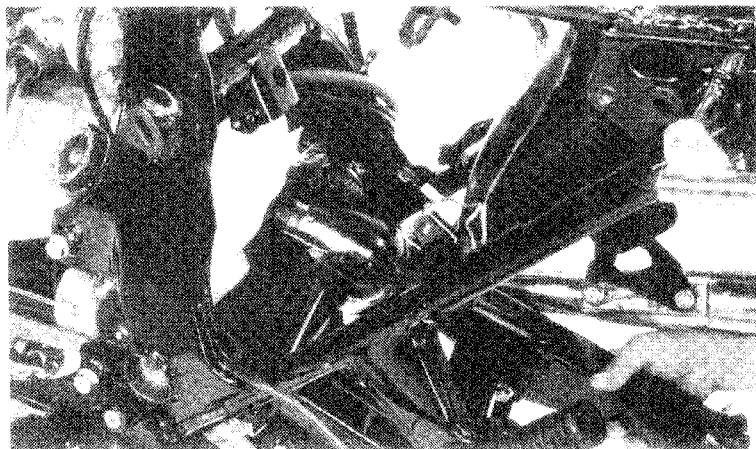



Apply grease to the tip of the pivot bolt and loosely install it.

NOTE

Make sure that the end of the pivot bolt is inserted into the bearing inner.

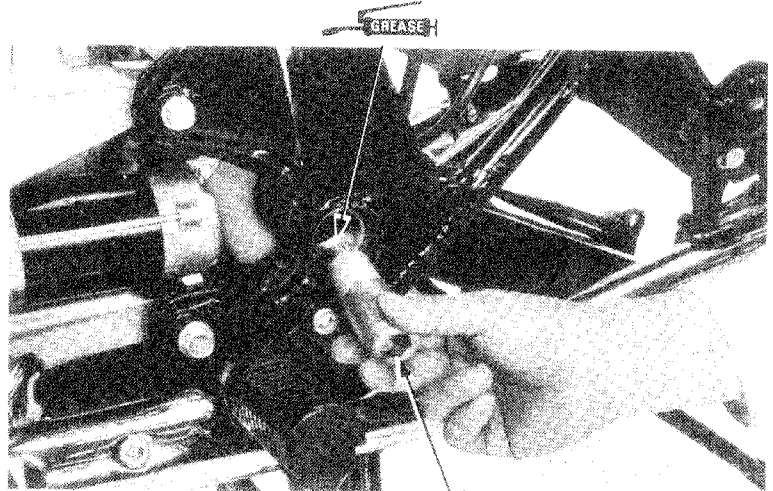

PIVOT BOLT

Tighten the pivot bolt to the specified torque.

TORQUE: 9–12 N·m
(0.9–1.2 kg-m, 7–9 ft-lb)

Move the swingarm up and down several times to seat the bearings with the pivot bolt.
Retighten the pivot bolt to the specified torque.

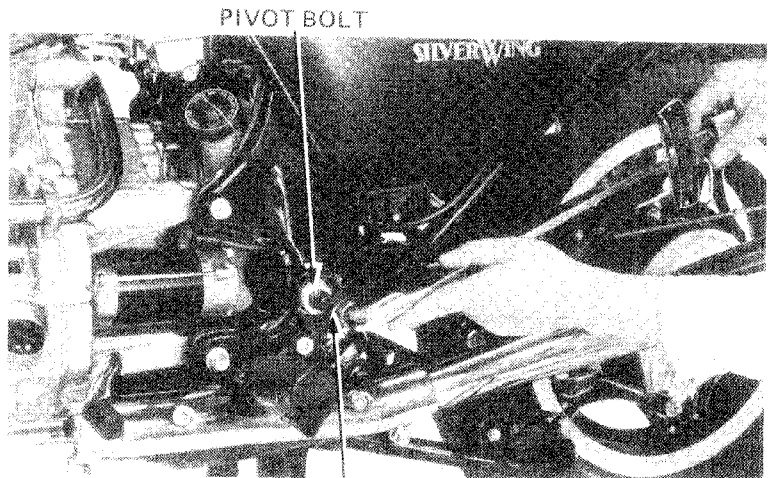

SOCKET BIT 17 mm

Install the pivot lock nut on the pivot bolt.
Hold the pivot bolt and tighten the pivot lock nut to a torque wrench reading of 82–108 N·m (8.2–10.8 kg-m, 59–78 ft-lb).

NOTE

Because the lock nut wrench increases the torque wrench's leverage, the torque actually applied to the lock nut is the specified torque value 90–120 N·m (9.0–12.0 kg-m, 65–87 ft-lb).

Install the pivot caps.

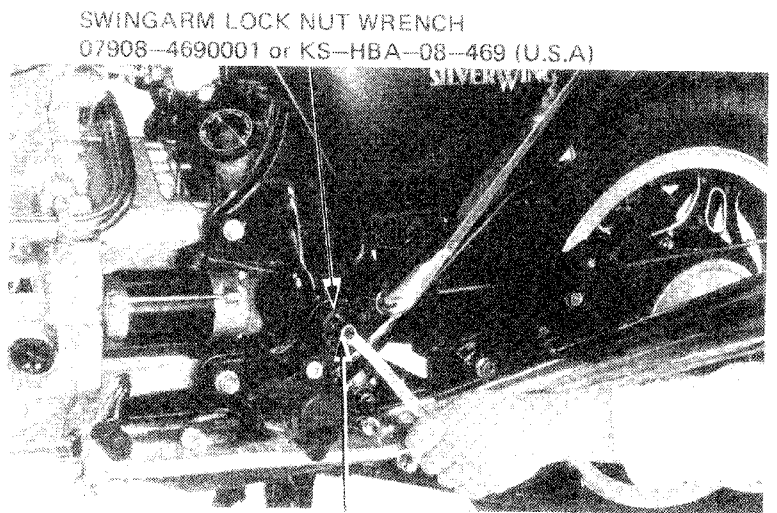

SOCKET BIT 17 mm

Install the rear brake pedal.

NOTE

Align the punch marks on the spindle and pedal.

Tighten the brake pedal bolt.

TORQUE: 10–15 N·m
(1.0–1.5 kg·m, 7–11 ft·lb)

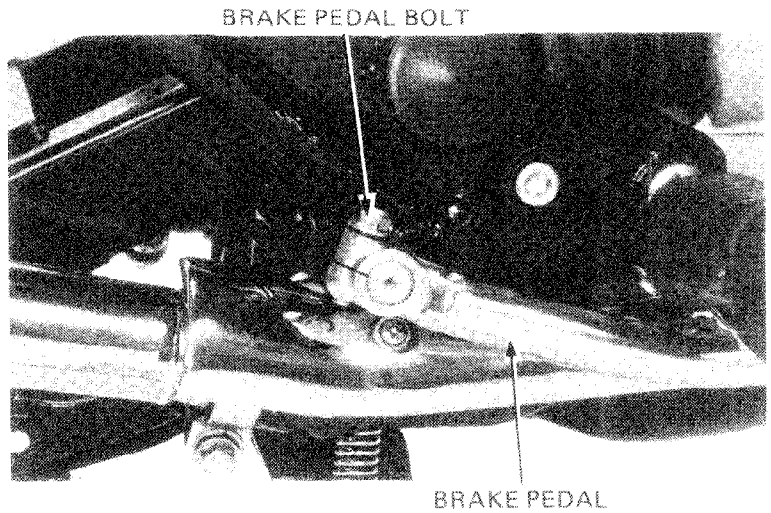

Lubricate the drive shaft splines with MULTI-PURPOSE NLG1 No. 2 (molybdenum disulfide additive) GREASE.

Attach the drive shaft and torque the lock bolt.

TORQUE: 18–28 N·m
(1.8–2.8 kg·m, 13–20 ft·lb)

WARNING

Check that the final shaft does not have more than 10 mm of the splines showing.

Install the boot securely.

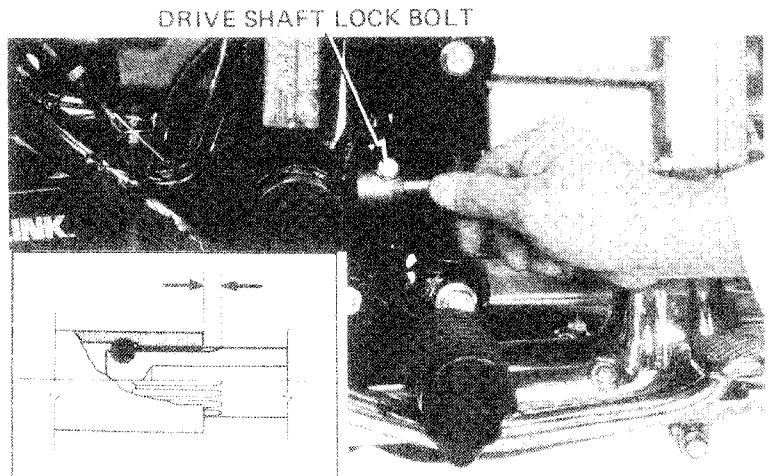

Install the final gear case (Page 14-40).

Install the rear wheel (Page 14-9).

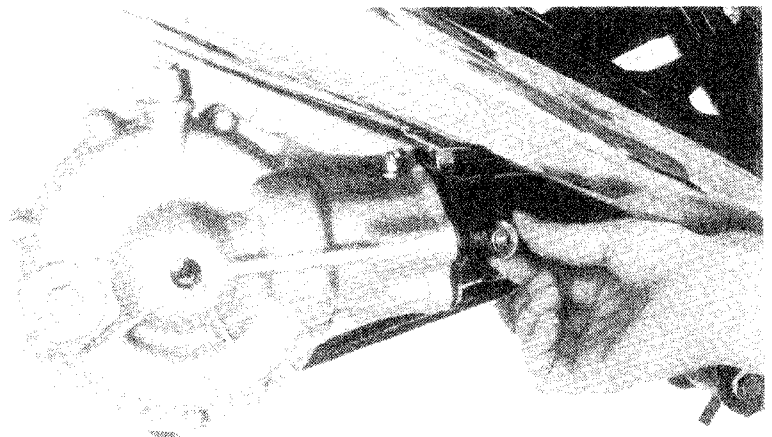



SUSPENSION LINKAGE

REMOVAL

Remove the muffler.
Remove the rear shock absorber lower mount bolt.
Remove the pivot bolt attaching the shock arm to the shock link.

LOWER MOUNT BOLT

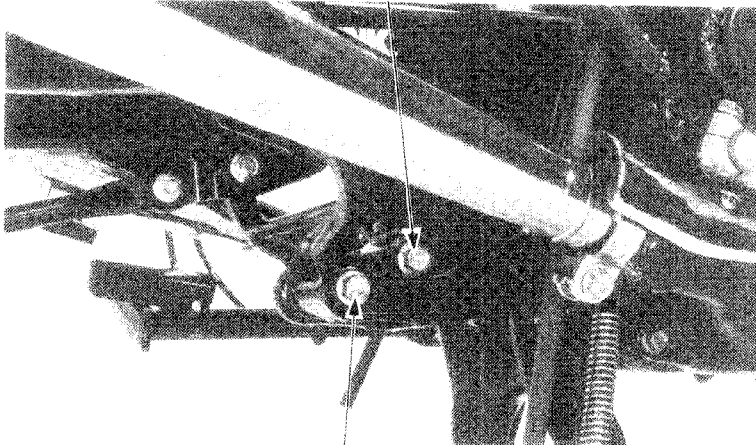

PIVOT BOLT

Remove the pivot bolts attaching the shock arm to the swingarm.

PIVOT BOLT

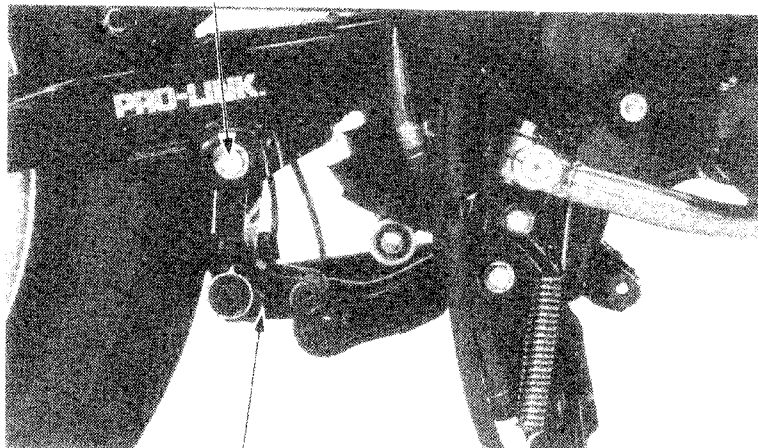

SHOCK ARM

Remove the shock link by removing the pivot bolt.

PIVOT BOLT

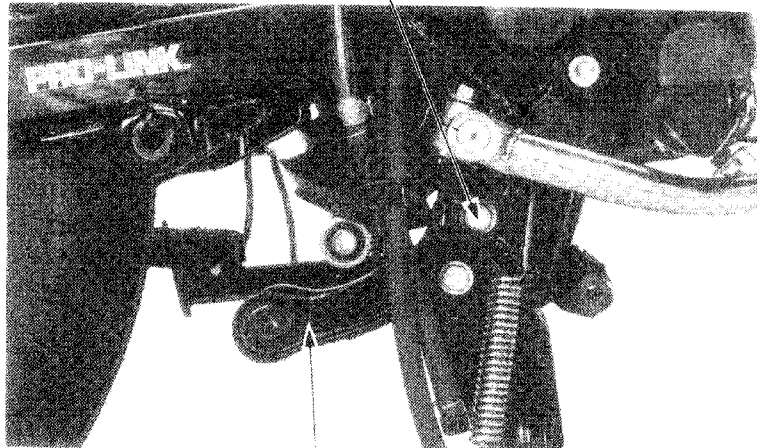

SHOCK LINK



INSPECTION

Inspect the outside surface of the collars and the inside of the bushings.

Replace them if they have score marks, scratches, or excessive or abnormal wear.

NOTE

The bushings are press-fitted. Do not remove the bushings unless they have to be replaced.

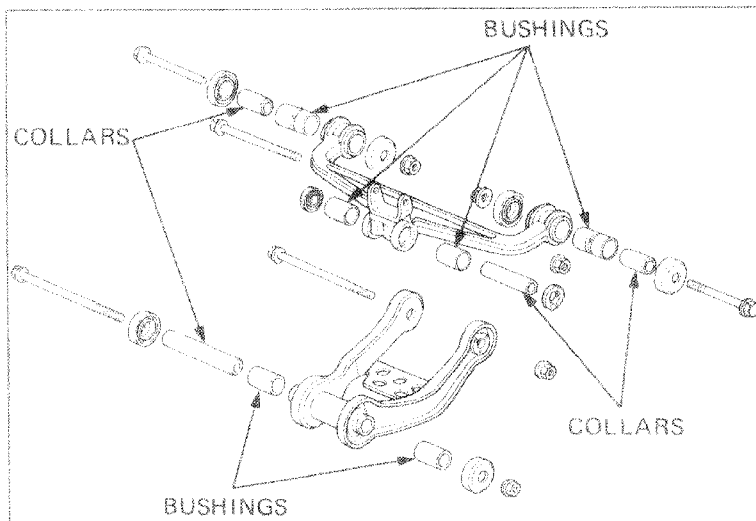

INSTALLATION

Apply paste grease (containing more than 45% molybdenum) to the inside of the bushings and dust seal lips.

NOTE

- Use molybdenum paste grease such as:
- MOLYKOTE® G PASTE or G-n PASTE manufactured by Dow Corning U.S.A.
 - Other lubricants of equivalent quality.

Install the collars and dust seals making sure that the sealing lips seat properly.

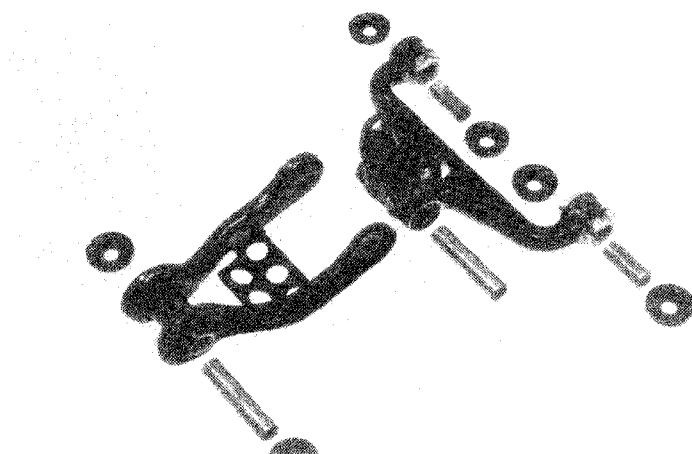

Attach the shock link onto the frame and torque the pivot bolt.

TORQUE: 45–55 N·m
(4.5–5.5 kg·m, 33–40 ft·lb)

Install the shock arm to the swingarm and torque the pivot bolts.

TORQUE: 45–55 N·m
(4.5–5.5 kg·m, 33–40 ft·lb)

Check the shock link and arm operation by moving them.

Connect the shock arm to the shock link and torque the pivot bolt.

TORQUE: 45–55 N·m
(4.5–5.5 kg·m, 33–40 ft·lb)

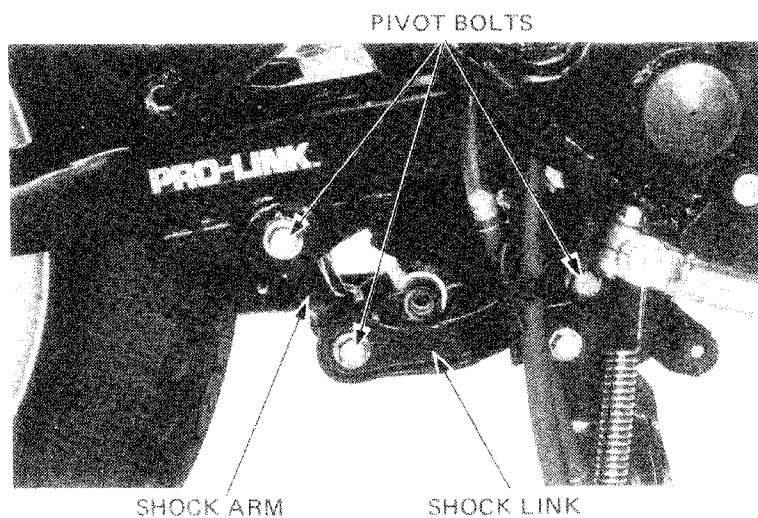



Install the shock absorber lower mount to the shock arm and torque the mount bolt.

TORQUE: 45–55 N·m
(4.5–5.5 kg·m, 33–40 ft·lb)

Install the muffler.

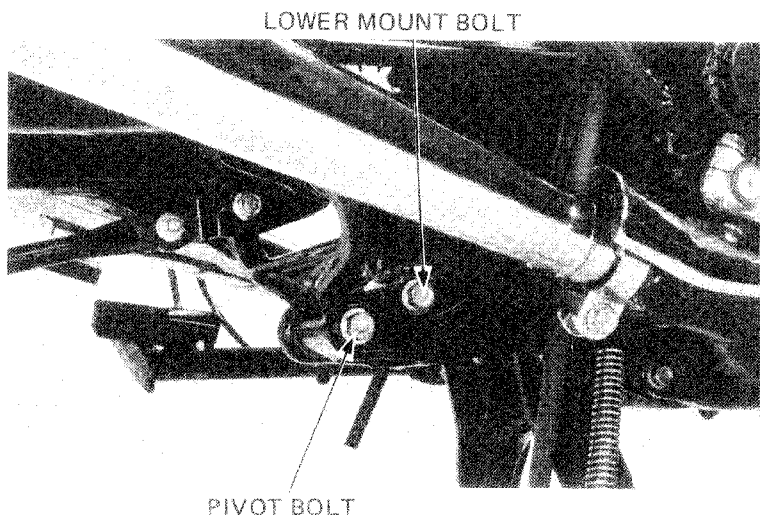

FINAL DRIVE

FINAL GEAR CASE REMOVAL

- Place the motorcycle on its center stand.
- Remove the rear wheel (Page 14-3).
- Remove the distance collar.
- Remove the final gear case attaching nuts.
- Remove the final gear case from the swingarm.

Drain the final gear case oil if disassembling the gear case.

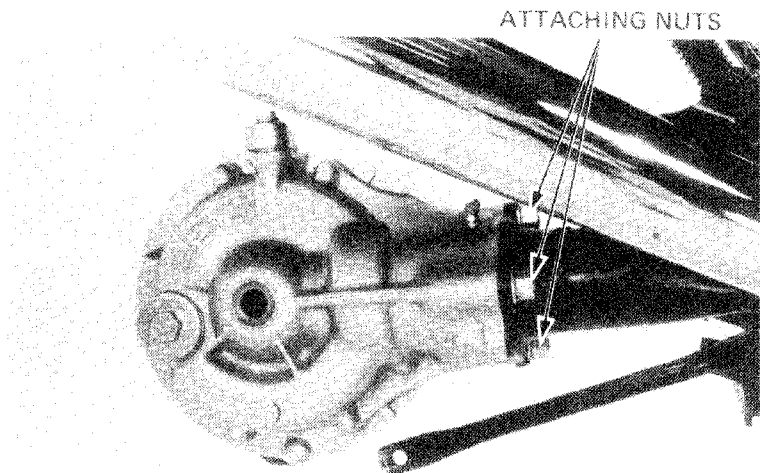

BACKLASH INSPECTION

Place the final gear case in a vise.

NOTE

Do not tighten the drive hub in the vise excessively.

- Install the preload inspection tool to hold the pinion gear securely.
- Set up a dial indicator on the ring gear teeth.
- Remove the oil filler cap.
- Set a horizontal type dial indicator on the ring gear, through the oil filler hole.
- Rotate the ring gear until gear slack is taken up.
- Turn the ring gear back and forth to read backlash.
 - Standard: 0.08–0.18 mm (0.003–0.071 in)
 - Service Limit: 0.25 mm (0.010 in)

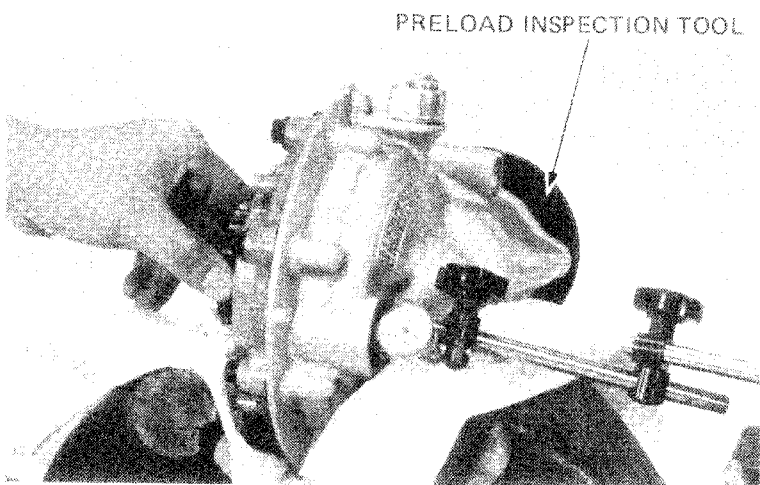



Remove the preload inspection tool and dial indicator. Turn the ring gear 120° and measure backlash. Repeat this procedure once more. Compare the difference between the three measurements.

Difference Of Measurement
Service Limit: 0.10 mm (0.004 in)

If backlash is excessive, check the pinion gear preload (Page 14-33) and final gear assembly preload (Page 14-37).
If preload is correct, the final drive assembly must be replaced.

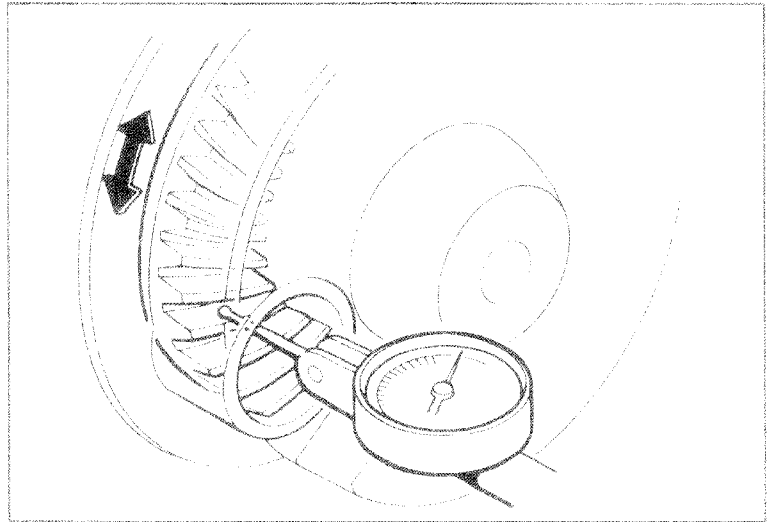

RING GEAR OIL SEAL REPLACEMENT

Straighten the tabs of the lock plates and remove the dust guard plate.

DUST GUARD
PLATE

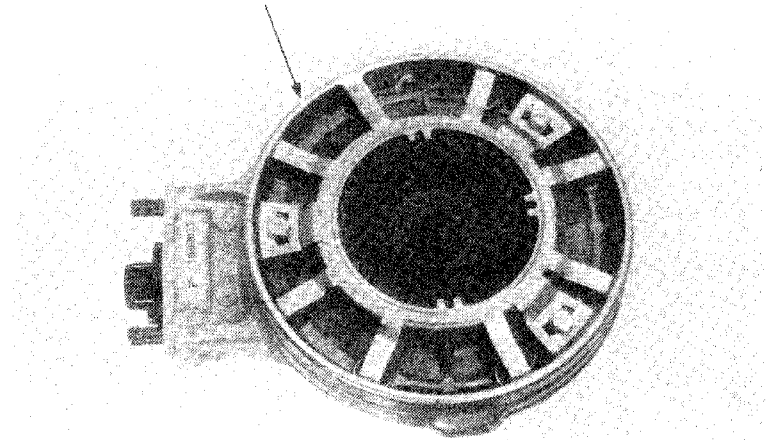

Remove the ring gear bearing retainer with the retainer wrench.
Remove the O-ring from the retainer.
Inspect the oil seal. If the lip is worn or damaged, or if the spring band is distorted, replace the oil seal.

EXTENSION BAR & HANDLE

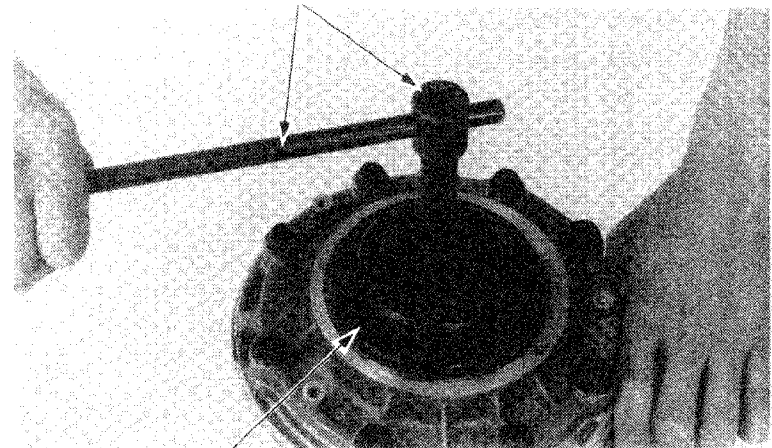

FINAL RETAINER WRENCH 07910-3710000



Remove the dust and oil seals from the retainer.
Coat the outer edges of both seals with gear oil.
Press the new seals into the retainer.
Coat the new O-ring with gear oil and install it.
Install the ring gear bearing retainer being careful
not to fold or damage the oil seal lips.

NOTE

- After installing the ring gear bearing preload
retainer, do the following:
- Final gear assembly preload check (Page
14-37).
 - Backlash inspection (Page 14-27).

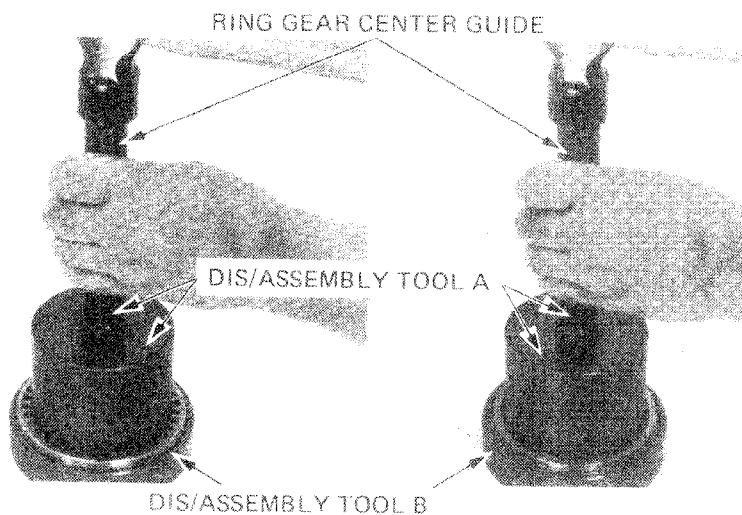

**RING GEAR REMOVAL/GEAR CASE OIL
SEAL REPLACEMENT**

Loosen the ring gear bearing preload retainer 5
notches with the retainer wrench.
Remove the eight gear case bolts.
Lift the cover from the gear case.

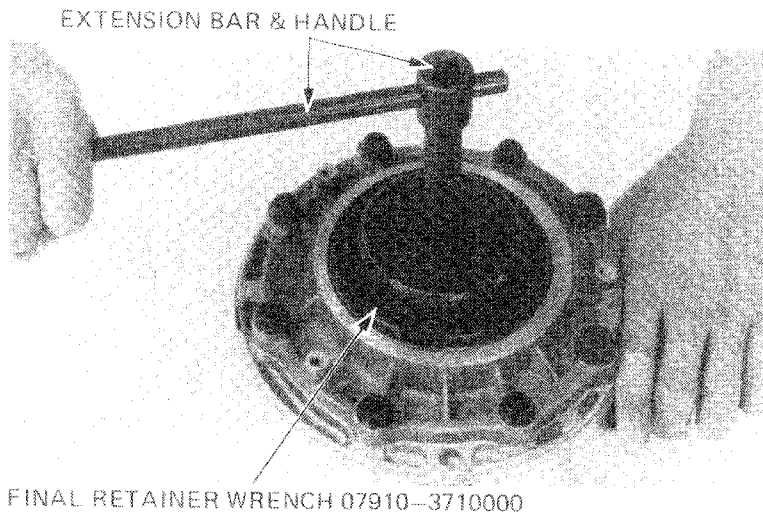

Separate the left case cover from the ring gear and
bearing by tapping it lightly with a plastic hammer
to avoid damaging the parts.

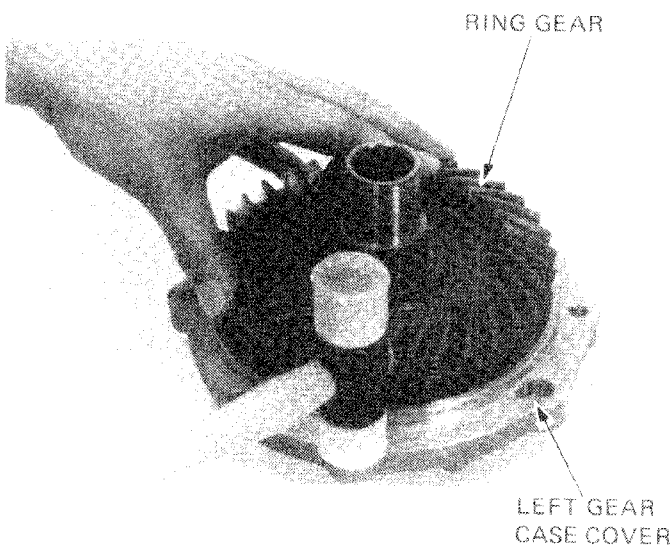



Inspect the ring gear oil seal for leaks.
Replace the seal if the lip is damaged or if the
spring band is distorted. If replacement is necessary,
it is necessary to remove the ring gear bearing.

NOTE

Drive the oil seal in squarely.

CAUTION

*Heat the gear case evenly when removing the
ring gear bearing race.*

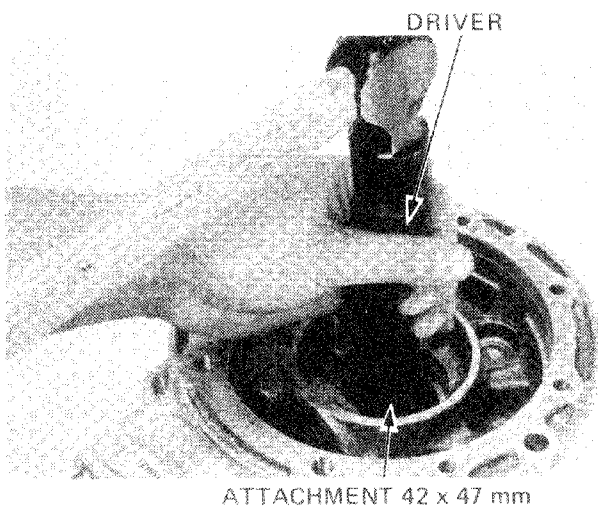

Inspect the bearing for smooth operation while
spinning it by hand. Replace the bearing with a new
one if it is noisy or has excessive play.

NOTE

- Drive the bearing in squarely.
- After replacing the bearing, check gear
backlash, tooth contact and final gear as-
sembly preload.

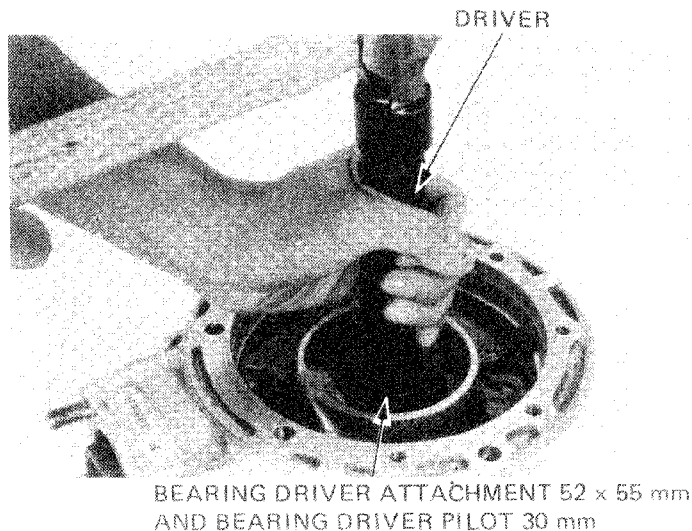

BREATHER SYSTEM MAINTENANCE

Check the breather hole for clogging. Clean if
necessary.
Clean around and inside of the breather cap.

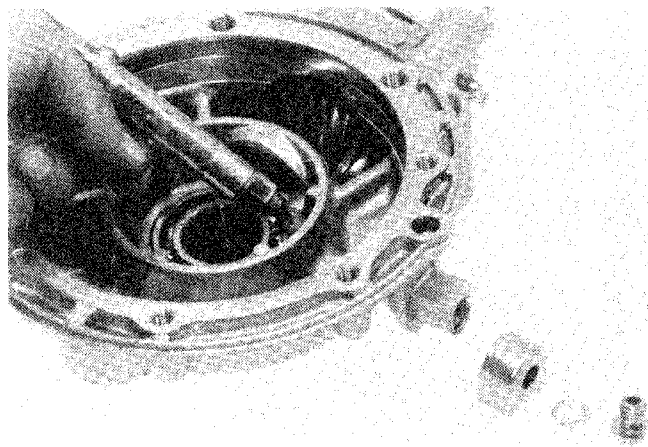



PINION GEAR RETAINER REMOVAL

Remove the pinion gear retainer lock washer.

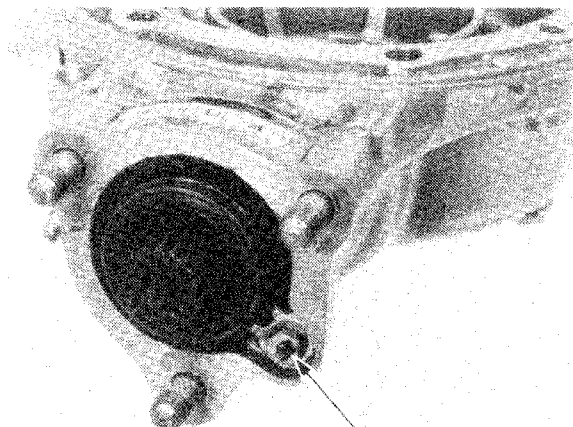

LOCK WASHER

Remove the retainer.

PINION RETAINER WRENCH
07910-MA10100 or 07910-4150000

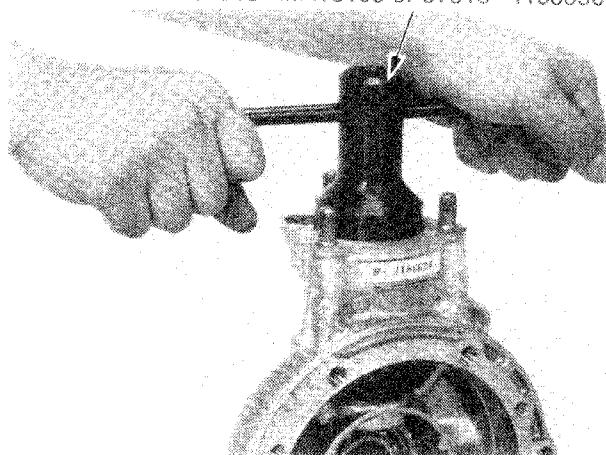

PINION GEAR RETAINER OIL SEAL, O-RING REPLACEMENT

Inspect the retainer oil seal. Replace the seal if the lip is worn or damaged, or if the spring band is distorted. Replace the O-rings.

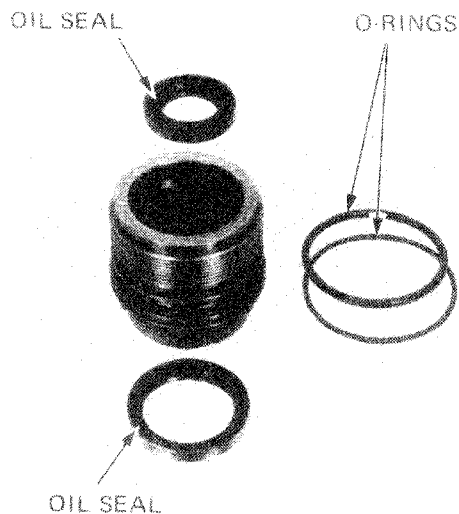

Fill the new oil seal groove with MULTIPURPOSE NLGI No. 2 (molybdenum disulfide additive) GREASE and install the oil seal into the retainer. Coat the new O-rings with the same grease and install them onto the retainer.

DRIVER 07749-0010000 or 07945-3710200

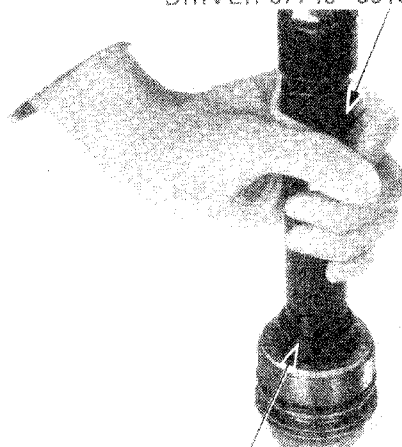

SEAL DRIVER ATTACHMENT 07945-4150200

PINION GEAR RETAINER INSTALLATION

Set the O-ring guide into the gear case cut-out, and oil seal guide over the pinion shaft.

OIL SEAL GUIDE 07973-MA10100

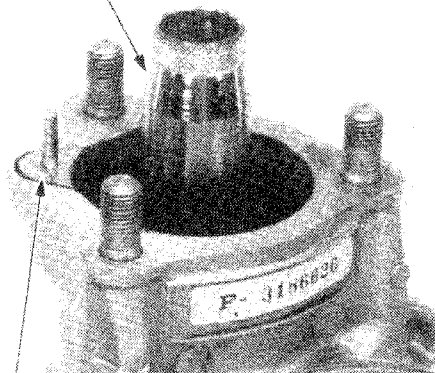

O-RING GUIDE 07973-MA10200

Push the retainer into place with the retainer wrench until the oil seal guide is contacted.

CAUTION

- Be careful not to damage the O-rings.
- The retainer has very fine threads, so be careful not to cross-thread it.

Remove the oil seal guide.

PINION RETAINER

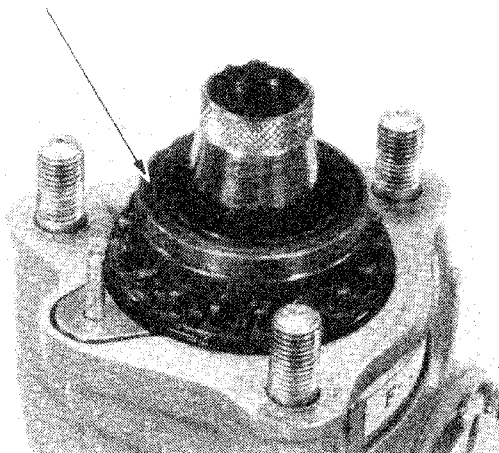



Thread the retainer into the case by hand. Turn the pinion shaft intermittently. Stop tightening the retainer when pinion shaft rotating resistance is felt. Do not overtighten the retainer.

Remove the O-ring guide.

NOTE

- If the retainer is overtightened, it will cause excessive preload.
- A high amount of drag is normal because of the O-rings.

PINION RETAINER WRENCH
07910-MA10100 or 07910-4150000

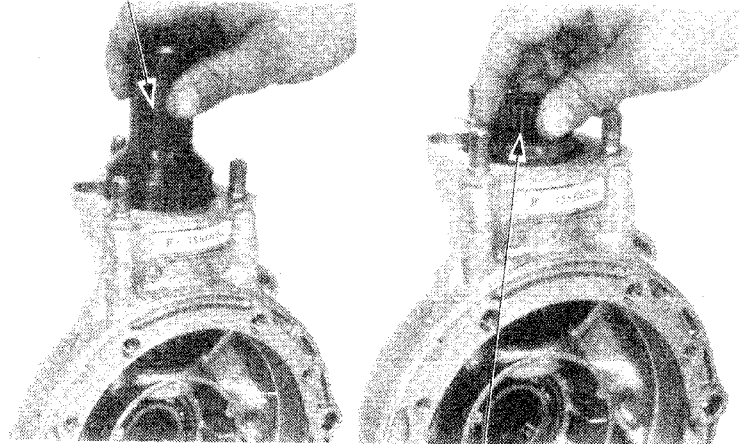

PINION SHAFT

PINION GEAR PRELOAD INSPECTION AND ADJUSTMENT

Wrap a wire around the tool groove and attach a spring scale. Measure the preload force needed to turn the pinion shaft in the normal direction of rotation.

Pinion Gear Preload:

Force: 800-1,000g (1.76-2.2 lbs)

Torque: 0.4-0.5 N·m
(4.0-5.0 kg-cm, 3.48-4.32 in-lb)

NOTE

- If measurements are not consistent, rotate the pinion gear 50-60 turns, then check preload.
- Force required to begin movement may exceed preload specifications.

PRELOAD INSPECTION TOOL 07998-4150000

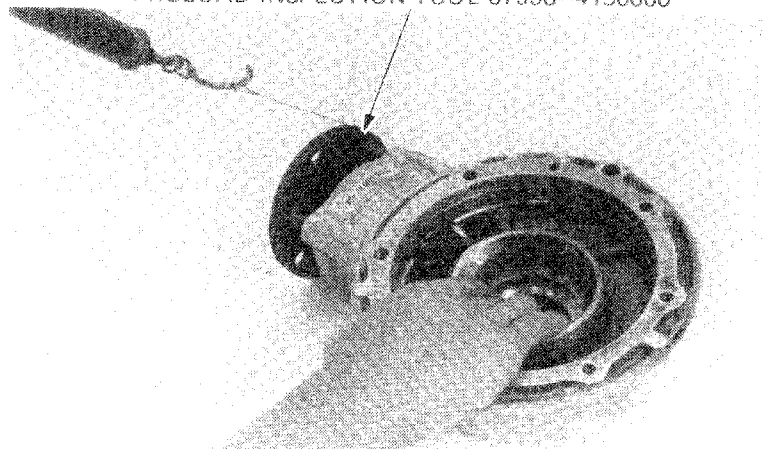

If preload is insufficient, remove the preload inspection tool, then install pinion gear retainer wrench and tighten the retainer.

Recheck the pinion gear preload.

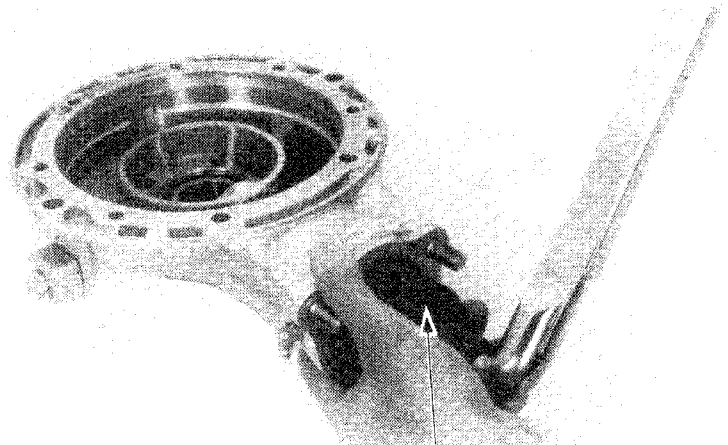

PINION RETAINER WRENCH
07910-MA10100 or 07910-4150000



If preload is excessive, remove the preload inspection tool, then install the pinion gear retainer wrench and remove the retainer. Pull up on the pinion shaft with the special tools, then recheck pinion preload.

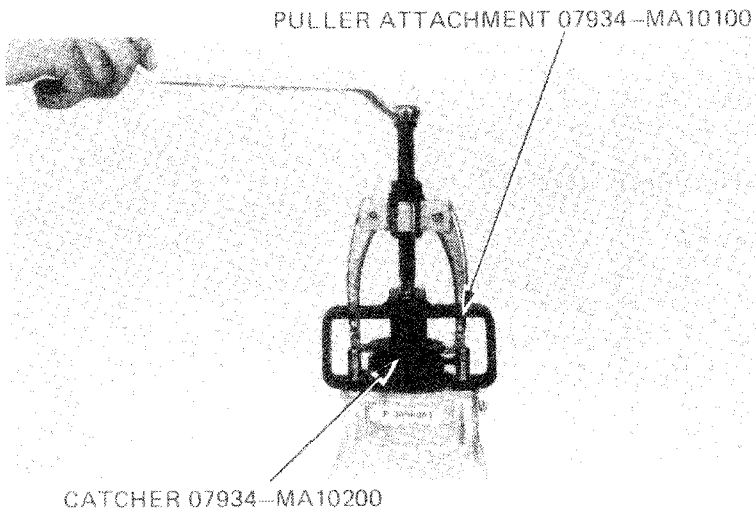

Install the retainer lock tab.

NOTE

The lock tabs are available in two types. Be sure to use the proper type lock tab.

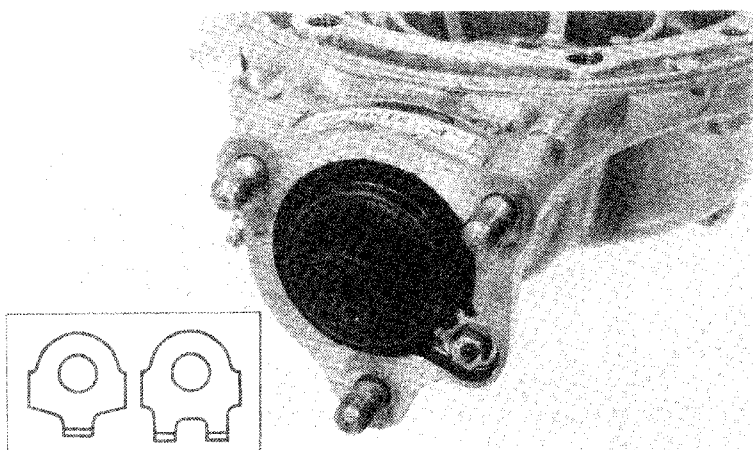

RING GEAR INSTALLATION

Clean all sealing material off the mating surfaces of the gear case and cover.

NOTE

- Do not allow dust and dirt to enter the gear case.
- Do not damage the mating surfaces of the gear case and cover.

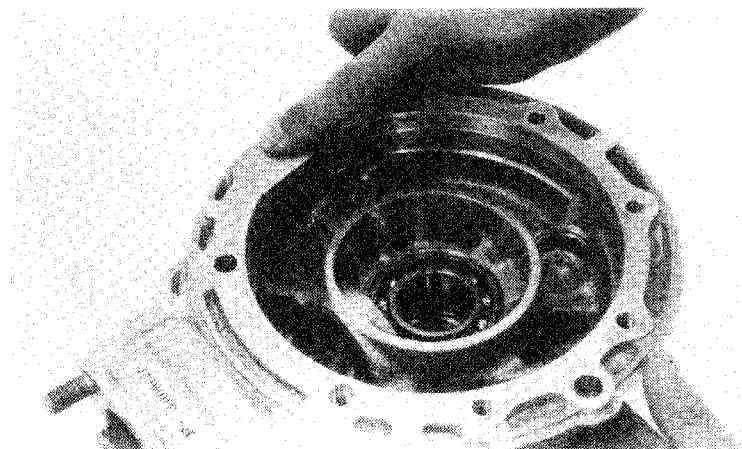



Clean the gear case cover mating surface with an oil stone.

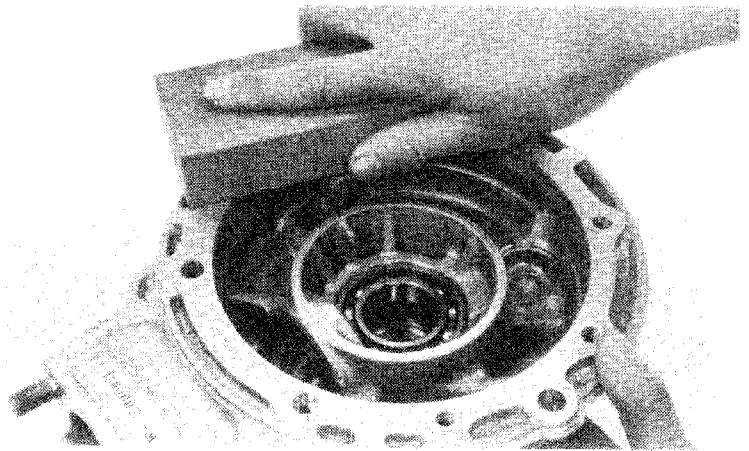

Apply liquid sealant to the mating surfaces of the gear case and cover.

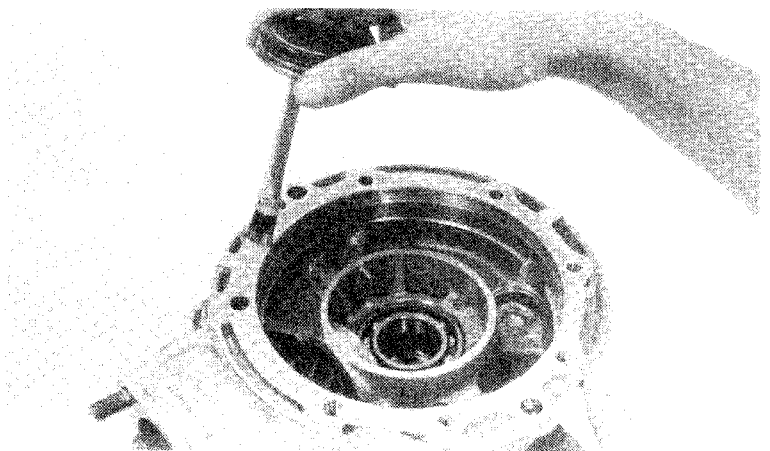

Apply a thin coating of Prussian Blue to the pinion gear teeth for gear tooth contact pattern check, prior to installing the ring gear. Install the ring gear assembly, being careful not to damage or fold the oil seal lips.

NOTE

Do not allow the left gear case cover to tilt during installation.

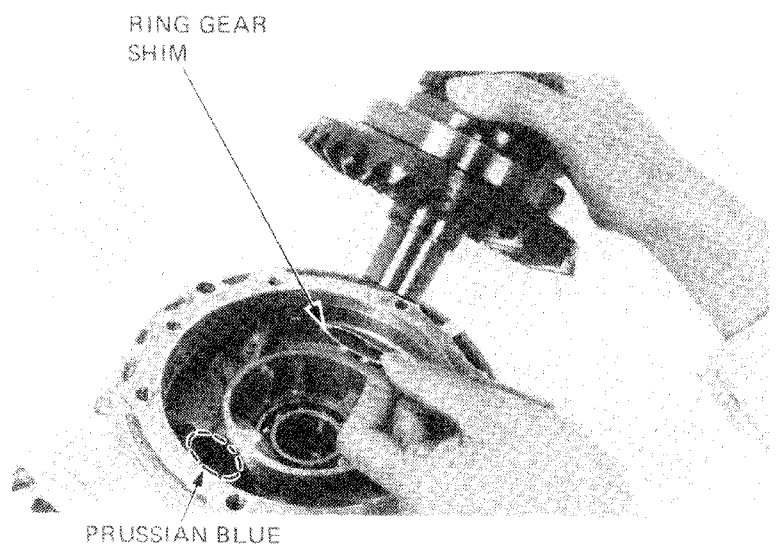

Place the gear case cover onto the final gear case. Tighten the cover bolts in 2-3 steps until the left gear case cover touches the gear case. Torque the bolts in a criss cross pattern in two or more steps.

TORQUE SPECIFICATION:

8 mm bolt: 23–28 N·m
2.3–2.8 kg·m, 17–20 ft·lb)

10 mm bolt: 35–45 N·m
(3.5–4.5 kg·m, 25–33 ft·lb)

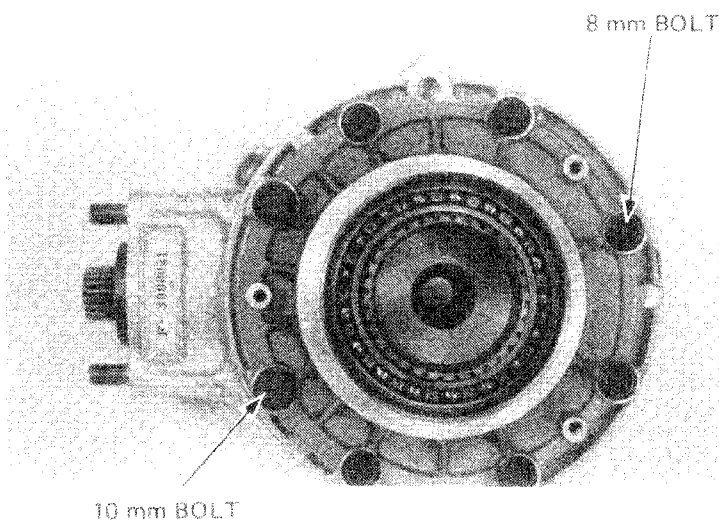

Fill the ring gear bearing retainer oil and dust seals with MULTIPURPOSE NLGI No. 2 (MoS₂ additive) GREASE.

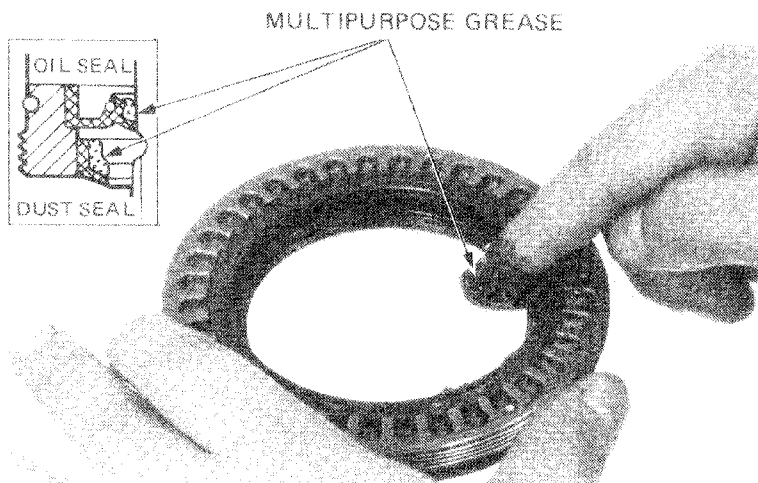

Install the ring gear retainer onto the gear case cover.

Before the retainer bottoms against the bearing, measure the torque (T) to overcome the friction caused by the O-ring.

Then tighten the retainer to T + 40 N·m (4.0 kg·m, 29 ft·lb) back off, and retighten to T + 10 N·m (1.0 kg·m, 7 ft·lb).

NOTE

After assembling the final gear case, perform the following operations:

- Backlash inspection
- Final gear preload check (Page 14-37)
- Final gear tooth contact pattern check (Page 14-37)

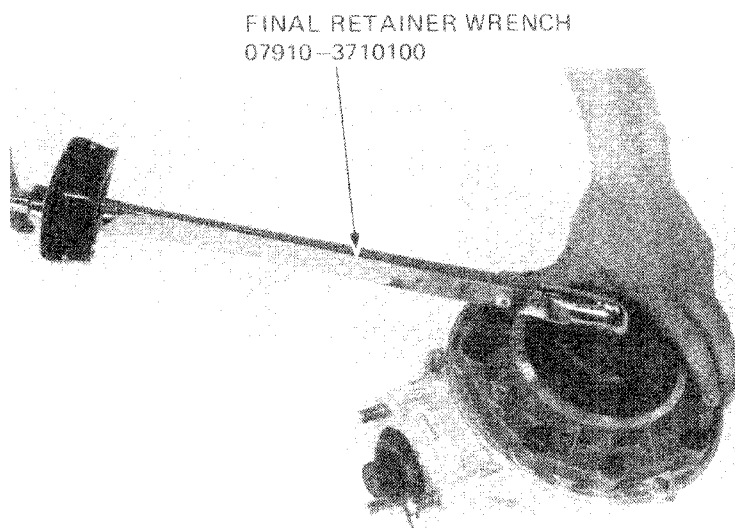



FINAL GEAR ASSEMBLY PRELOAD INSPECTION AND ADJUSTMENT

NOTE

Use this inspection and adjustment whenever the ring gear retainer is removed, or if final gear assembly preload is being checked.

Install the preload inspection tool.
Attach a spring scale to the wire. Measure the preload force needed to run the pinion shaft in the normal direction of rotation.

FINAL GEAR ASSEMBLY PRELOAD:

- Force: 1,200–1,800g (2.65–3.97 lbs)
- Torque: 0.6–0.9 N·m
(6.0–9.0 kg·cm, 5.16–7.80 in·lb)

If the preload exceeds specifications, remove the ring gear and check the pinion gear preload (Page 14-33).

If the pinion gear preload is within the specifications, install the ring gear and ring gear retainer and adjust the final gear assembly preload by tightening the retainer.

NOTE

- Tighten the retainer gradually while measuring the preload.
- Loosen the ring gear retainer and turn the pinion gear several times, if preload is excessive.

PRELOAD INSPECTION TOOL
07998-4150000

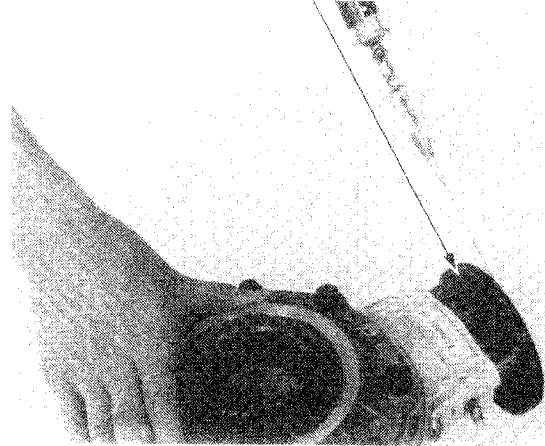

GEAR TOOTH CONTACT PATTERN CHECK AND ADJUSTMENT

Remove the oil filler cap from the final gear case.
Check the gear tooth contact pattern by rotating the ring gear several times in the normal direction of rotation. The gear tooth contact pattern is indicated by Prussian Blue applied to the pinion before assembly.

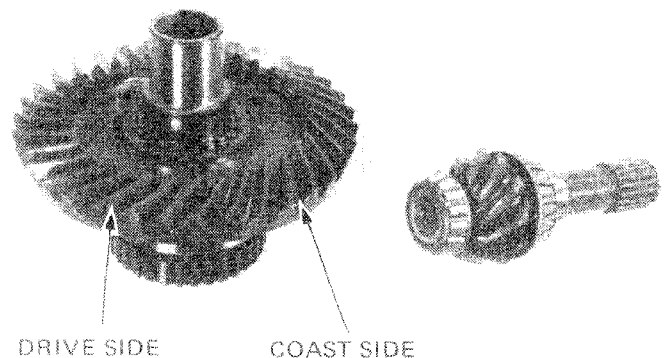

REAR WHEEL/BRAKE/FINAL DRIVE/ SUSPENSION



Contact is normal if the Prussian Blue is transferred to the approximate center of each tooth flank slightly extending toward the toe side.

If the patterns are not correct, adjust contact by replacing the pinion shim. (The ring gear shim affects the contact patterns very little).

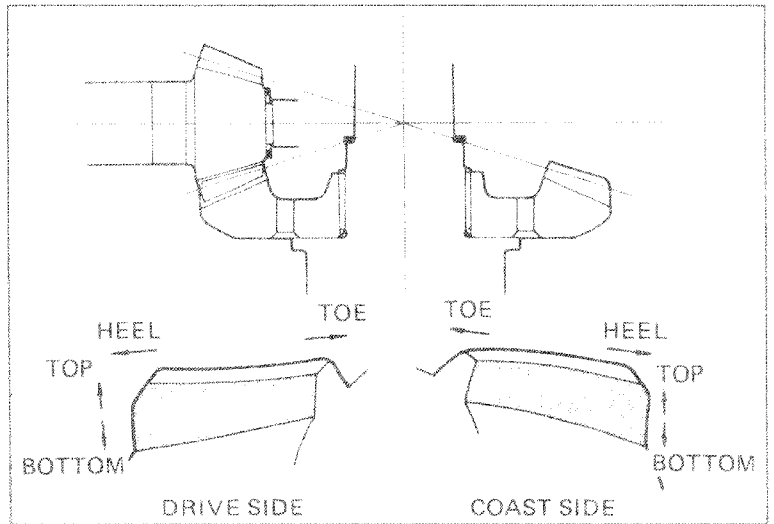

The pattern will be too high on both the drive and coast side if the shim is too thick. Use a thinner shim to correct the pattern.

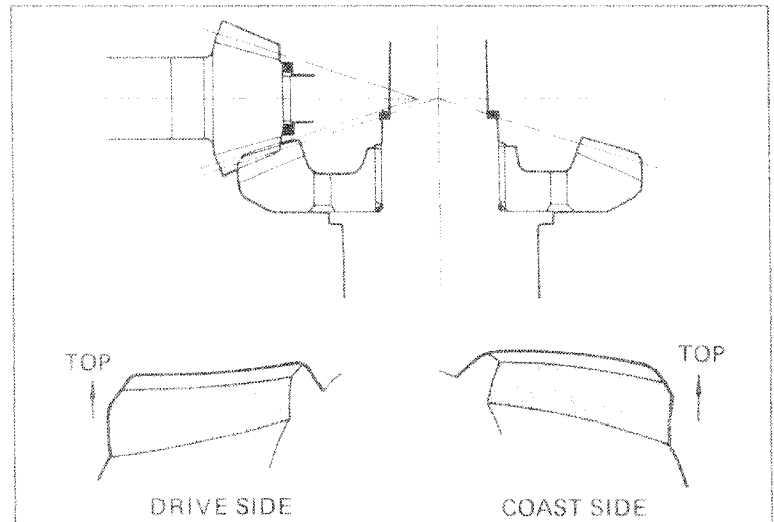

The pattern will be too low on both the drive and coast sides if the shim is too thin.

Use a thicker shim to correct the pattern.

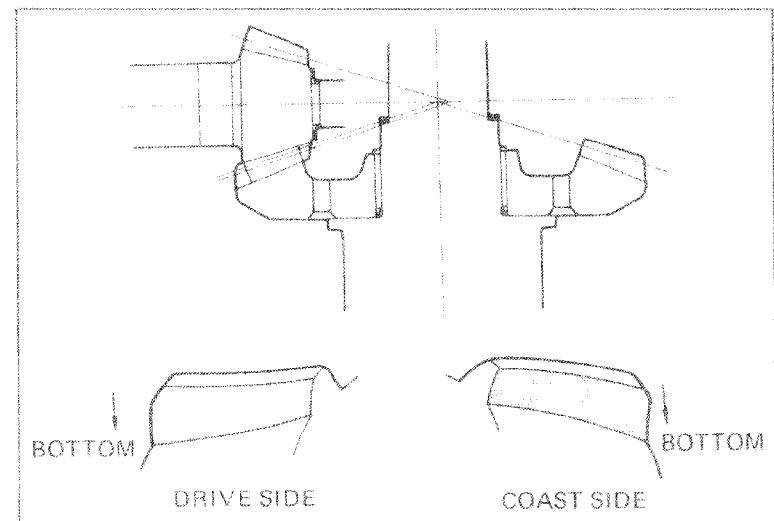



The pattern will be shifted toward the toe or heel on both sides if the bearings are not installed squarely. Re-install the bearings to correct the pattern.

NOTE

Use of a worn pinion on a new ring gear or a worn ring gear on a new pinion can cause improper contact pattern.

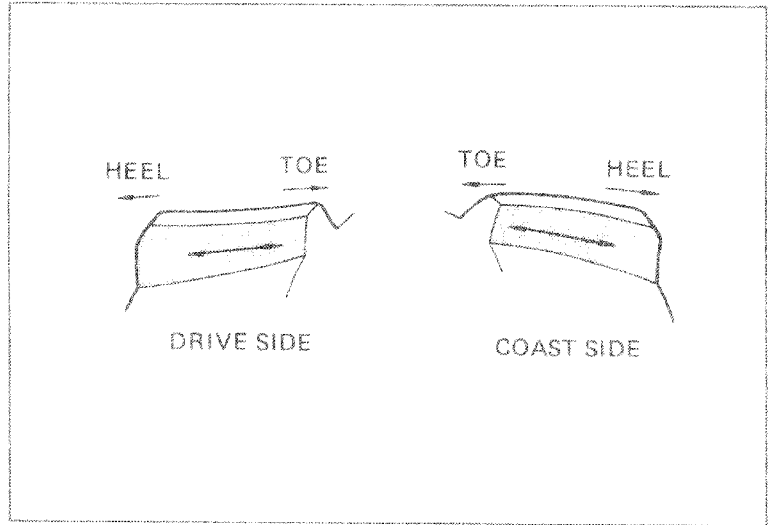

BACKLASH INSPECTION AND ADJUSTMENT

Measure the backlash (Page 14-27). If the backlash is excessive, replace the ring gear shim with a thinner one. If the backlash is too small, replace the ring gear shim with a thicker one.

NOTE

Backlash adjustment should be made with the ring gear shim as the pinion shim hardly affects the backlash.

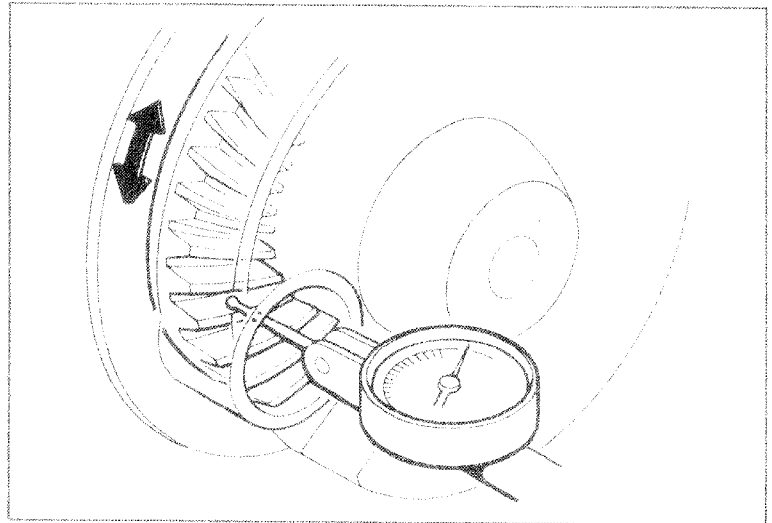

Install the dust guard plate and torque the bolts. Bend the tabs of the lock plates up to prevent the bolts from being turned out during operation. Bend one of the four ring gear bearing retainer lock tabs.

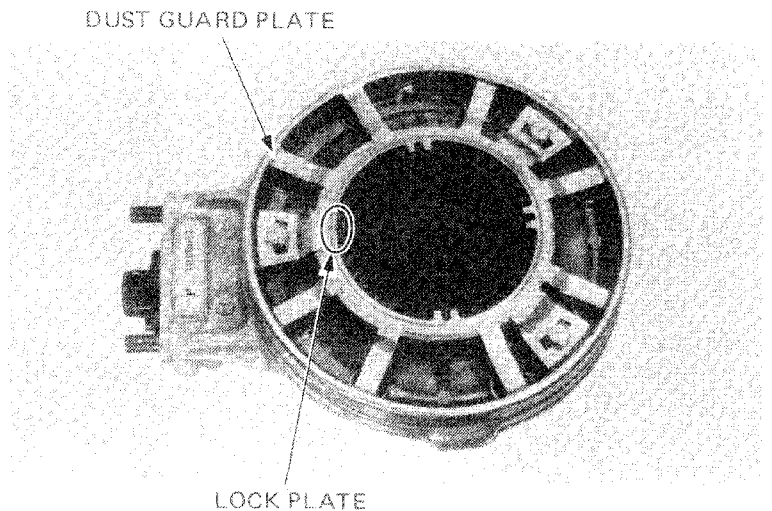



FINAL GEAR CASE INSTALLATION

Lubricate the splines of the propeller shaft and pinion gear shaft with MULTIPURPOSE NLGI No. 2 (molybdenum disulfide additive) GREASE, and engage.

Temporarily install the gear case on the swingarm.

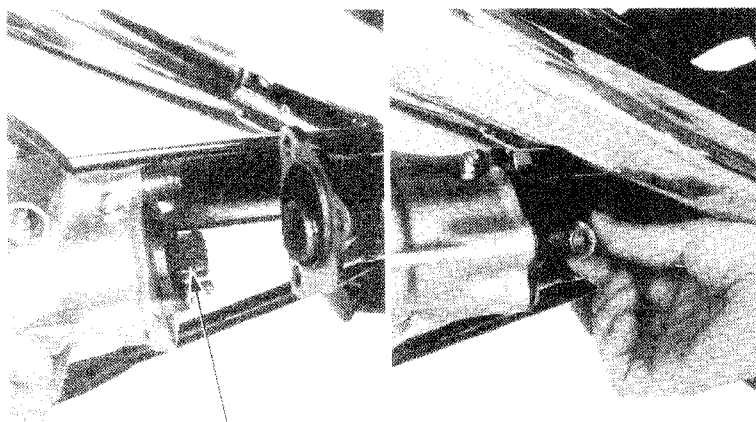

MULTIPURPOSE NLGI
No.2 (MoS₂ ADDITIVE)

Insert the distance collar into the ring gear shaft.

Apply MULTIPURPOSE NLGI No. 2 (molybdenum disulfide additive) GREASE to the splines of the rear wheel and ring gear shaft.

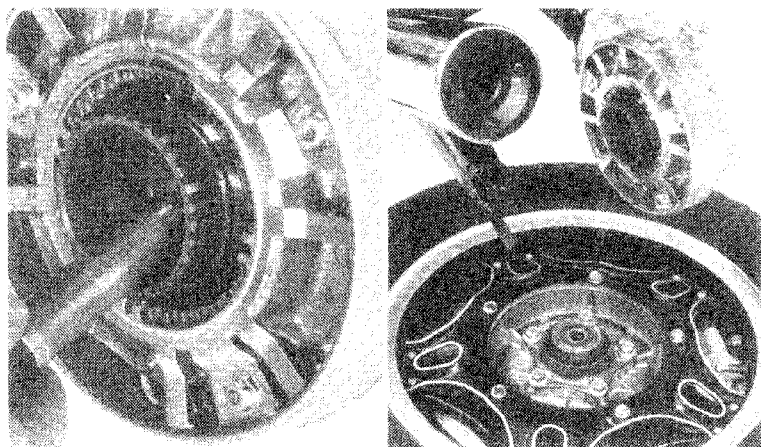

Install the rear wheel (Page 14-9).

Tighten the final gear case nuts.

**TORQUE: 45–70 N·m (4.5–7.0 kg-m,
33–51 ft-lb)**

Tighten the axle nut

**TORQUE: 50–80 N·m (5.0–8.0 kg-m,
36–58 ft-lb)**

Tighten the axle pinch bolt.

**TORQUE: 20–30 N·m (2.0–3.0 kg-m,
14–22 ft-lb)**

FINAL GEAR CASE NUT

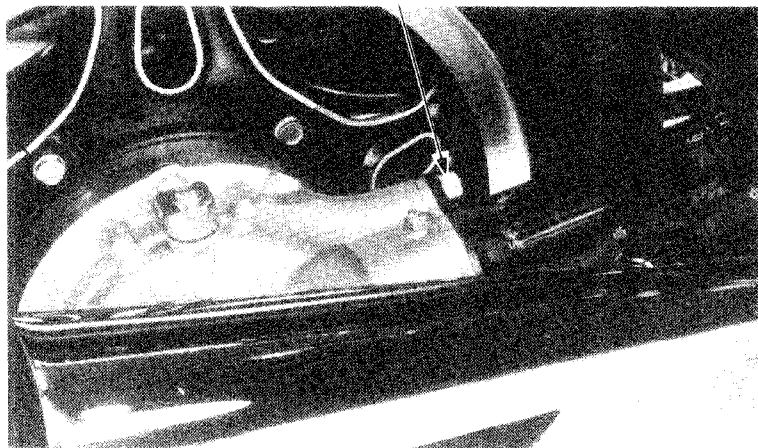



PINION GEAR LUBRICATION

Pump lithium-based multipurpose grease through the grease fitting.

GREASE QUANTITY: 45 cc approx.

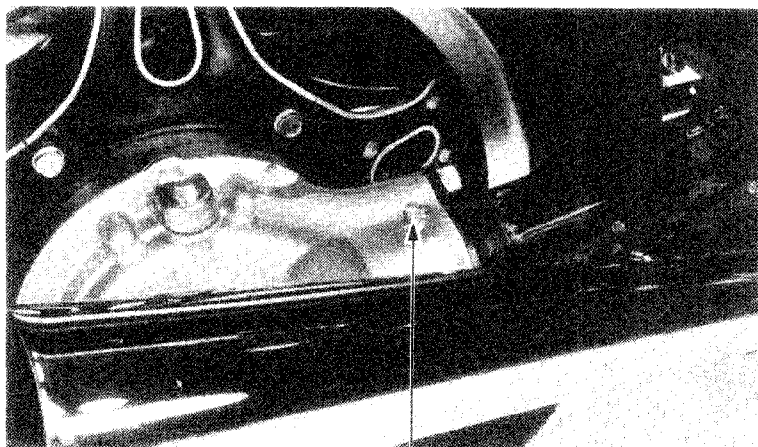

GREASE FITTING

FILLING FINAL GEAR CASE

Place the motorcycle on its center stand.

Make sure that the drain bolt is tightened.

Remove the oil filler cap.

Pour the specified amount of recommended oil up to the filler neck.

RECOMMENDED OIL: HYPOID GEAR OIL

Over 5°C: SAE 90

Below 5°C: SAE 80

OIL CAPACITY: 160-180 cc

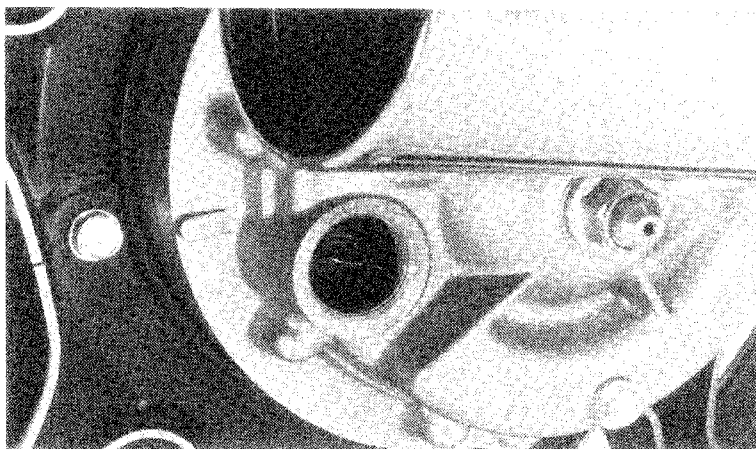

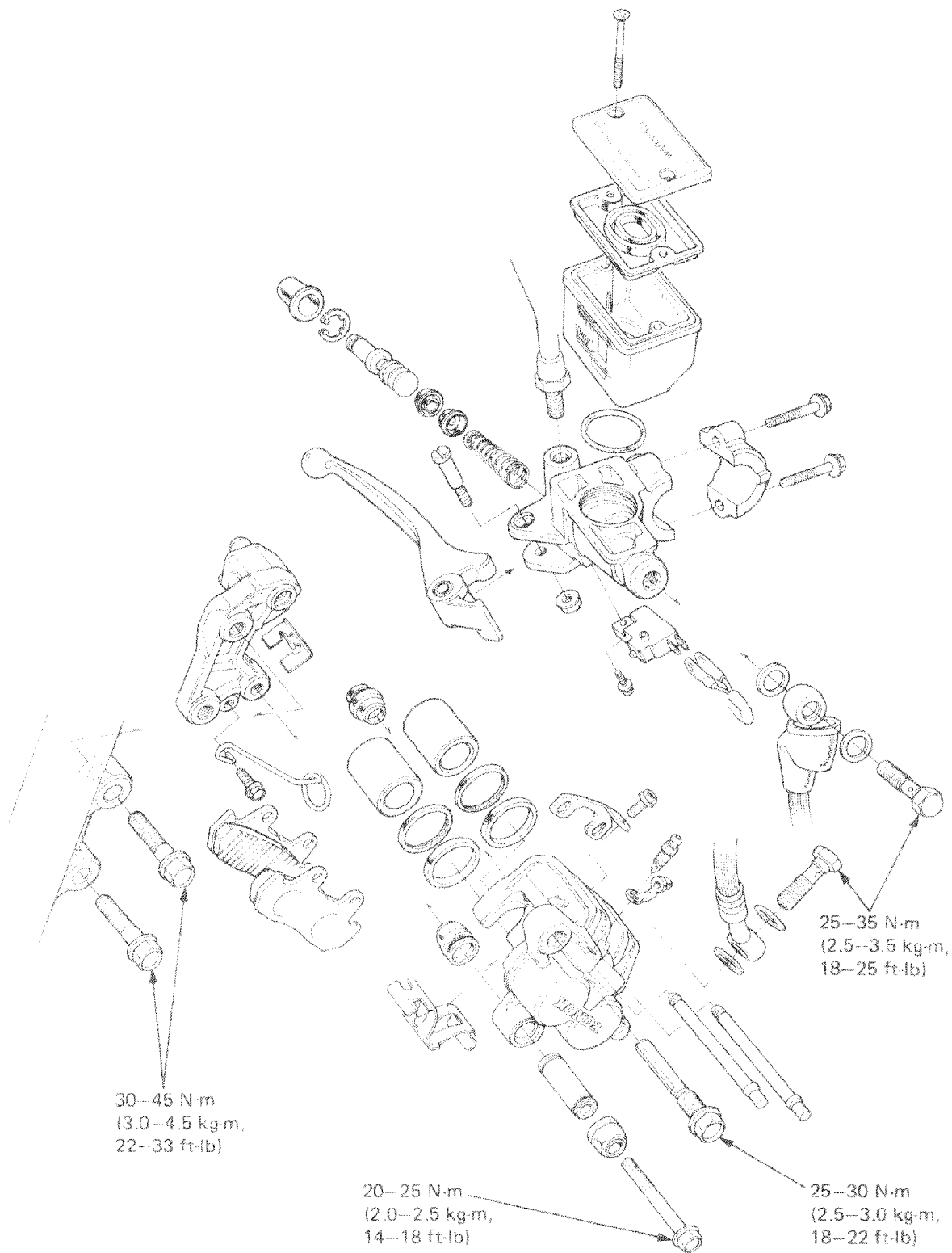



15. HYDRAULIC BRAKE

SERVICE INFORMATION	15-1	BRAKE PADS/DISC PLATE	15-3
TROUBLESHOOTING	15-1	BRAKE MASTER CYLINDER	15-6
BRAKE FLUID REPLACEMENT/ AIR BLEEDING	15-2	BRAKE CALIPER	15-8

SERVICE INFORMATION

GENERAL INSTRUCTIONS

- The front brake can be removed without disconnecting the hydraulic system. Once the hydraulic systems have been opened, or if the brakes feel spongy, the system must be bled.
- Do not allow foreign material to enter the system when filling the reservoir.
- Avoid spilling brake fluid on painted surfaces or instrument lenses, as severe damage will result.
- Always check brake operation before riding the motorcycle.

TOOL

Special
Snap Ring Pliers 07914-3230001

TORQUE VALUES

Brake hose bolt 25-35 N·m (2.5-3.5 kg·m, 18-25 ft·lb)
Front brake caliper mount bolt 35-45 N·m (3.5-4.5 kg·m, 25-33 ft·lb)
Front brake caliper pivot bolt 25-30 N·m (2.5-3.0 kg·m, 18-22 ft·lb)
Front brake caliper bolt 20-25 N·m (2.0-2.5 kg·m, 14-18 ft·lb)

SPECIFICATIONS

Unit : mm (in)

Item		Standard	Service limit
Disc thickness	GL500	6.9-7.1 (0.27-0.28)	6.0 (0.24)
	GL500I	4.9-5.1 (0.19-0.20)	4.0 (0.16)
Disc runout		-----	0.3 (0.01)
Master cylinder I.D.	GL500	15.870-15.913 (0.6248-0.6265)	15.925 (0.6270)
	GL500I	14.000-14.043 (0.5512-0.5529)	14.055 (0.5533)
Master piston O.D.	GL500	15.827-15.854 (0.6231-0.6242)	15.815 (0.6226)
	GL500I	13.957-13.984 (0.5495-0.5506)	13.945 (0.5490)
Caliper piston O.D.		30.148-30.198 (1.1869-1.1889)	30.140 (1.1866)
Caliper cylinder I.D.		30.230-30.280 (1.1901-1.1921)	30.290 (1.1925)

TROUBLESHOOTING

Poor Brake Performance

1. Air bubbles in hydraulic system
2. Worn brake pads
3. Pads dirty or glazed
4. Hydraulic system leaking



HYDRAULIC DISC BRAKE

BRAKE FLUID REPLACEMENT/ AIR BLEEDING

Check the fluid level with the fluid reservoir parallel to the ground.

CAUTION

- Install the diaphragm on the reservoir when operating the brake lever. Failure to do so will allow brake fluid to squirt out of the reservoir during brake operation.
- Avoid spilling fluid on painted surfaces. Place a rag over the fuel tank whenever the system is serviced.

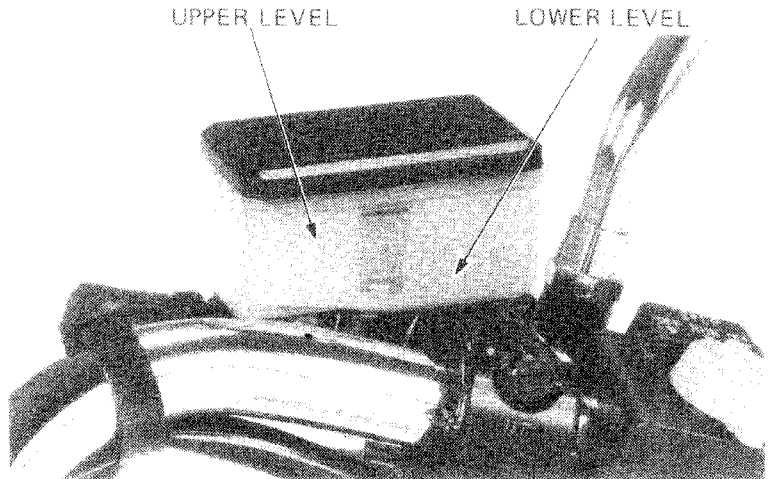

BRAKE FLUID DRAINING

Connect a bleed hose to the bleed valve.
Loosen the caliper bleed valve and pump the brake lever.
Stop pumping the lever when no more fluid flows out of the bleed valve.

WARNING

- A brake disc or pad contaminated with brake fluid or grease reduces stopping power. Discard contaminated pads and clean the disc with a high quality brake degreasing agent.

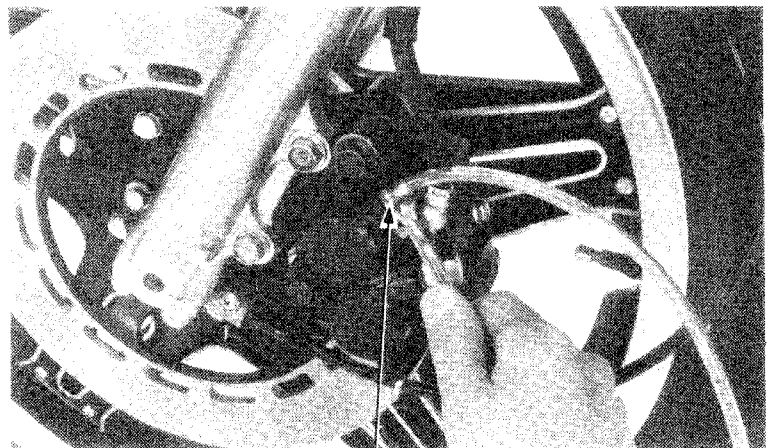

BLEED VALVE

BRAKE FLUID FILLING

NOTE

- Use ONLY DOT-3 brake fluid from a sealed container.

Close the bleed valve, fill the reservoir, and install the diaphragm.

AIR BLEEDING

To prevent piston overtravel and brake fluid seepage, keep a 20 mm (3/4 in) space between the lever and the handlebar grip when bleeding the front brake system. Pump up the system pressure until there are no air bubbles in the fluid flowing out of the reservoir small hole and lever resistance is felt.

NOTE

- Check the fluid level often while bleeding the brake to prevent air from being pumped into the system.

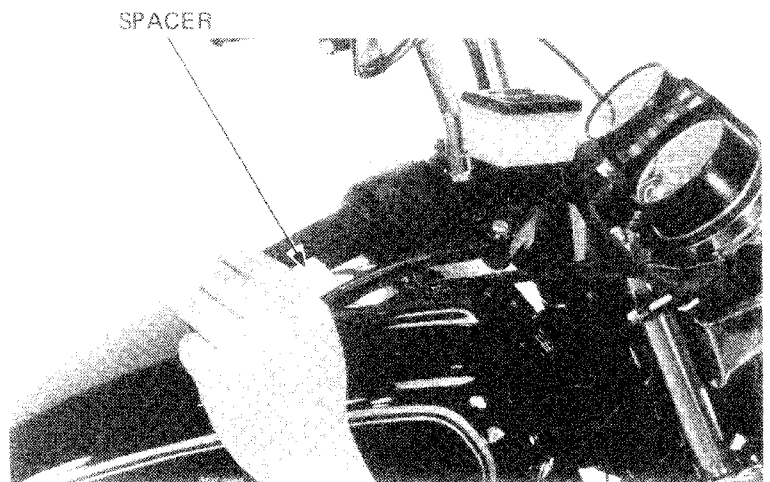

SPACER

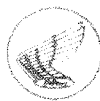

BRAKE PADS/DISC PLATE

PAD REPLACEMENT

NOTE

Always replace the brake pads in pairs to assure even disc pressure.

Remove the caliper bolt and pivot the caliper up out of the way.

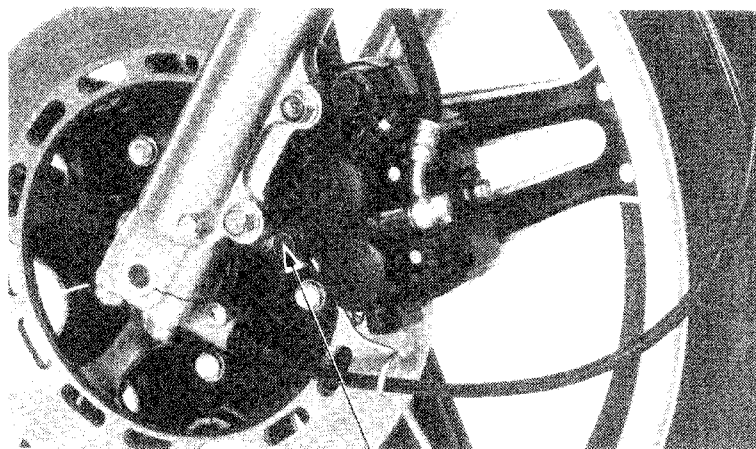

CALIPER BOLT

Remove the retainer bolt and the pad pin retainer. Pull the pad pins out of the caliper. Remove the brake pads.

RETAINER BOLT

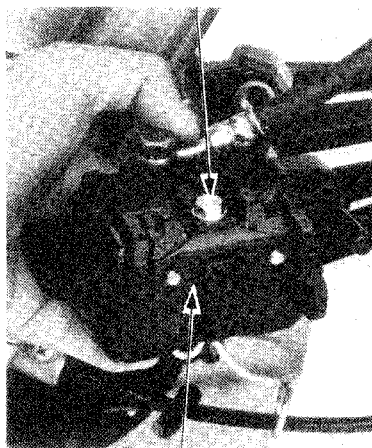

RETAINER

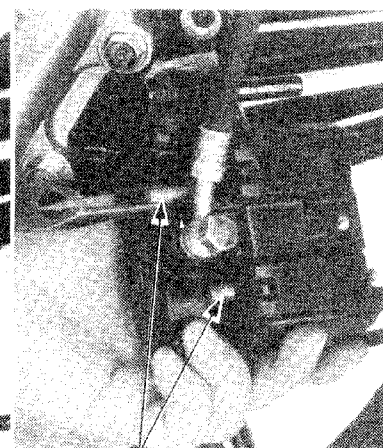

PAD PINS

Position the anti-rattle spring in the caliper as shown.

ANTI-RATTLE SPRING

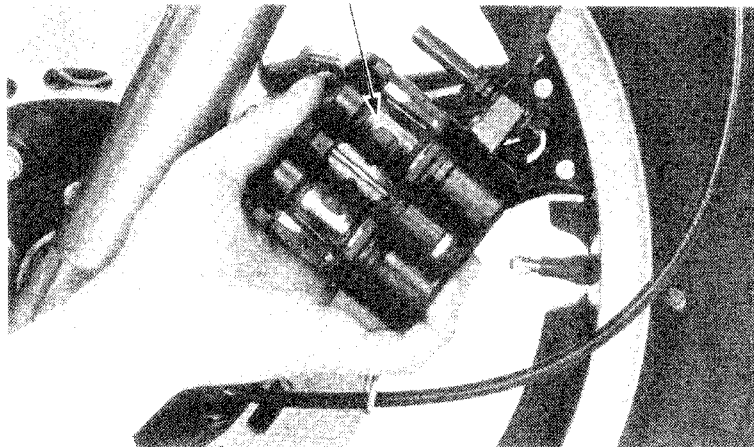



HYDRAULIC DISC BRAKE

Install the new pads in the caliper.
Install the pad pins.

NOTE

Install one pad pin first then install the other pin by pushing the pads against the caliper to depress the anti-rattle spring.

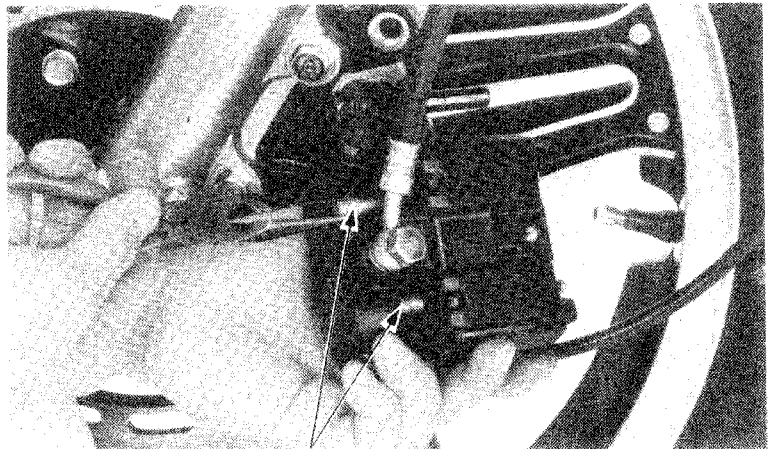

PAD PINS

Slide the pad pin retainer over the pad pins through the larger side of the slots in the retainer and slide the retainer to secure the pad pins.
Install the pad pin retainer bolt.

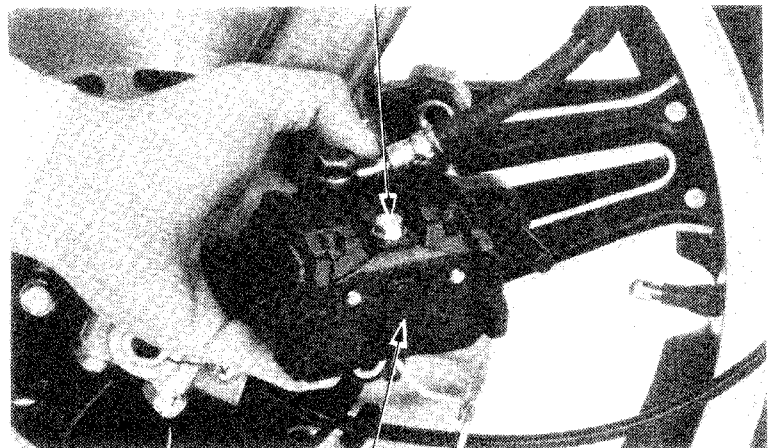

RETAINER BOLT

RETAINER

Push the piston all the way in to allow installation of new brake pads.

NOTE

Check the brake fluid level in the brake master cylinder reservoir as such operation causes the level to rise.

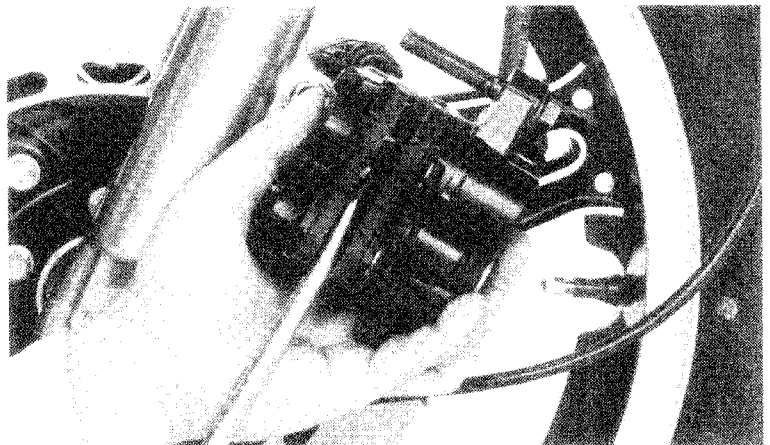



Pivot the caliper down so the brake disc is positioned between the pads, making sure not to damage the pads.

Install the caliper bolt and tighten it.
TORQUE: 20–25 N·m (2.0–2.5 kg·m,
14–18 ft·lb)

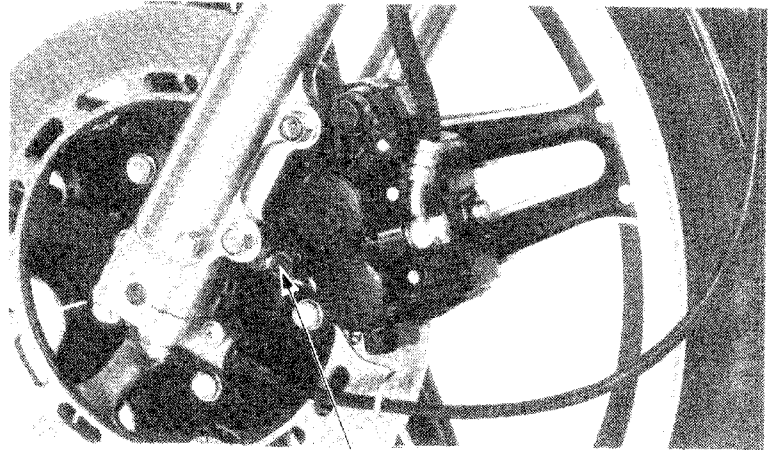

CALIPER BOLT

BRAKE DISC THICKNESS

Measure the brake disc thickness.

SERVICE LIMIT:
STANDARD MODEL: 6.0 mm (0.24 in)
INTERSTATE MODEL: 4.0 mm (0.16 in)

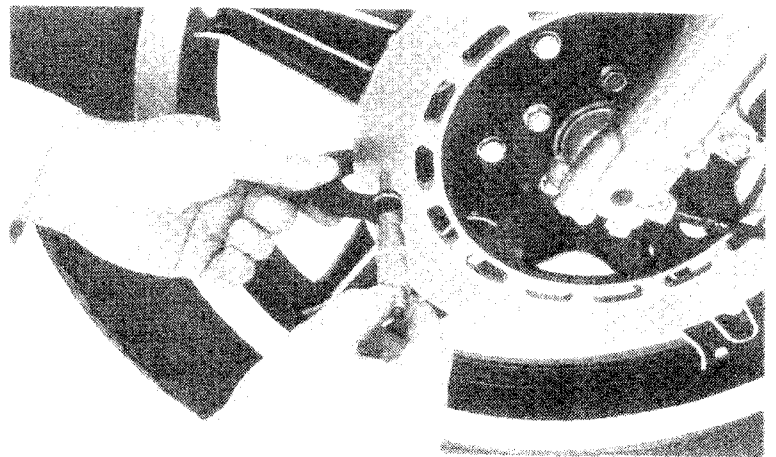

BRAKE DISC WARPAGE

Measure the brake disc warpage.

SERVICE LIMIT: 0.30 mm (0.012 in)

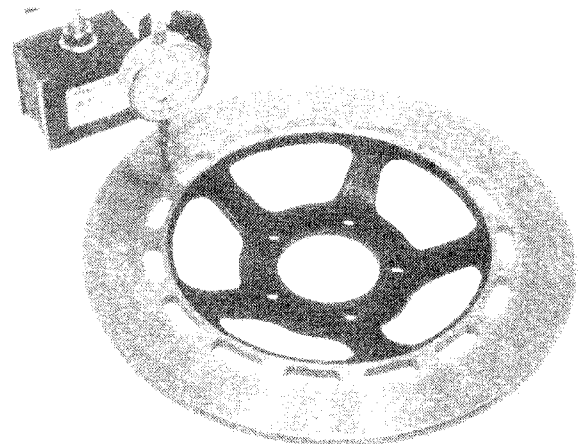

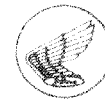

HYDRAULIC DISC BRAKE

BRAKE MASTER CYLINDER

MASTER CYLINDER DISASSEMBLY

Remove the rear view mirror and brake lever.

Drain the brake fluid from the hydraulic system.
Remove the brake hose bolt and disconnect the brake hose.

CAUTION

*Avoid spilling brake fluid on painted surfaces.
Place a rag over the fuel tank and instrument
whenever the brake system is serviced.*

Remove the master cylinder.

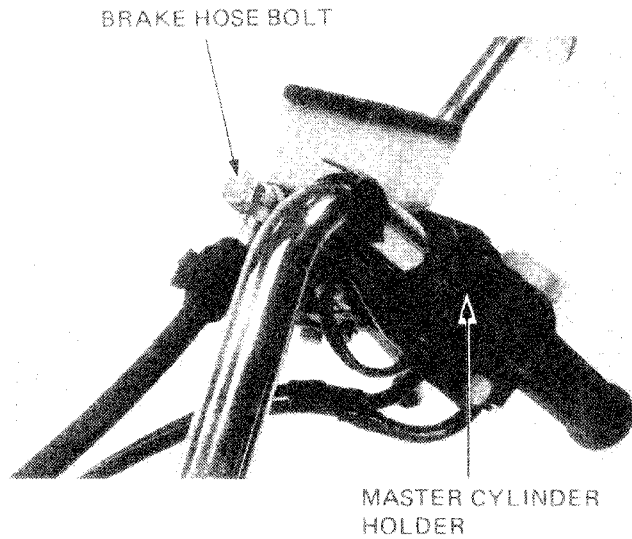

Remove the dust boot.

Remove the circlip.
Clean the interior of the master cylinder and reservoir with brake fluid.

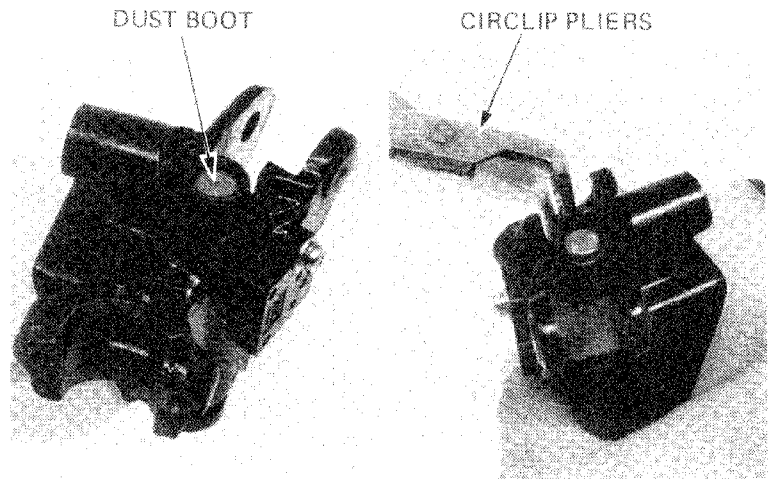

MASTER CYLINDER I.D. INSPECTION

Measure the master piston bore I.D.

SERVICE LIMIT:

GL500: 15.925 mm (0.6270 in)
GL500I: 14.055 mm (0.5533 in)

Check for scores, scratches, nicks or other damage.

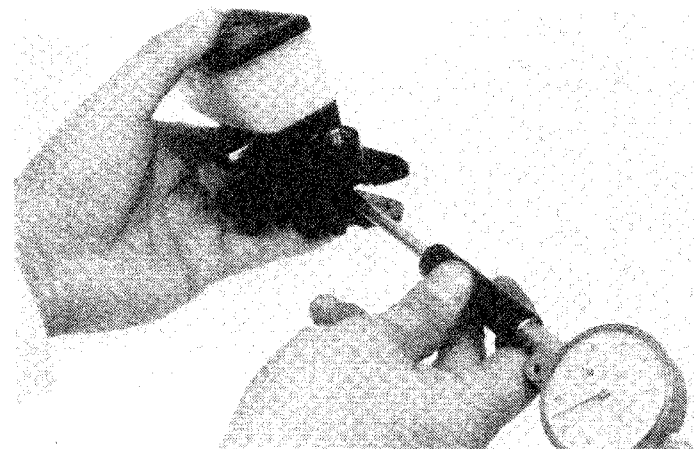



MASTER PISTON O.D. INSPECTION

Measure the master piston O.D.

SERVICE LIMIT:

GL500: 15.815 mm (0.6225 in)

GL500I: 13.945 mm (0.5490 in)

MASTER PISTON

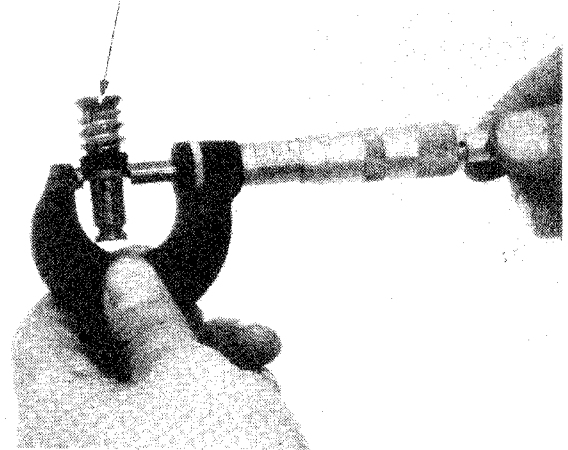

MASTER CYLINDER ASSEMBLY

CAUTION

Replace the master cylinder piston, cylinder and spring as a set.

Dip the piston cup in brake fluid or coat with silicon grease before assembly.

Install the master cylinder on the handlebar.

(Page 13-7).

Connect the brake hose and install the brake lever.

Bleed the front brake system. (Page 15-2).

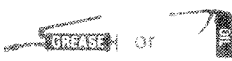
 **GREASE** or **BRAKE FLUID DOT-3**
SILICON GREASE

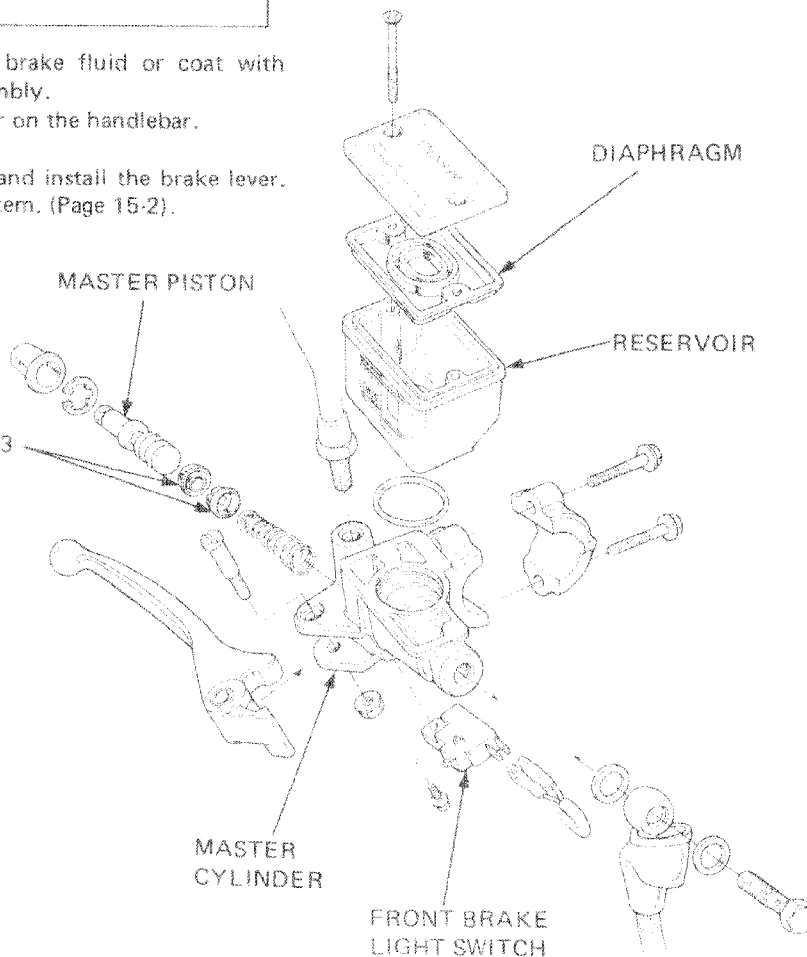

BRAKE CALIPER

CALIPER REMOVAL

Drain the brake hydraulic system.
Disconnect the brake hose.

NOTE

Avoid spilling brake fluid on painted surfaces,
the front forks and disc plate.

To remove the brake caliper, remove the caliper
pivot bolt and mount bolt.

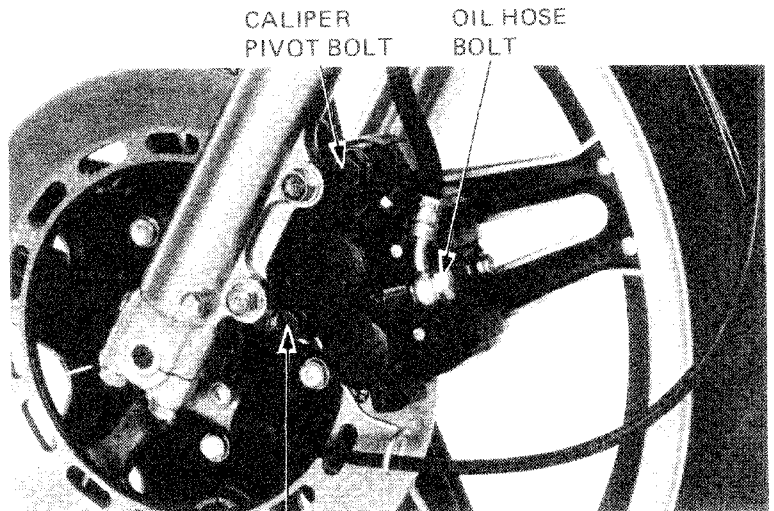

CALIPER MOUNT BOLT

CALIPER DISASSEMBLY

Remove the pads and anti-rattle spring.
Remove the caliper pivot collar and boots.

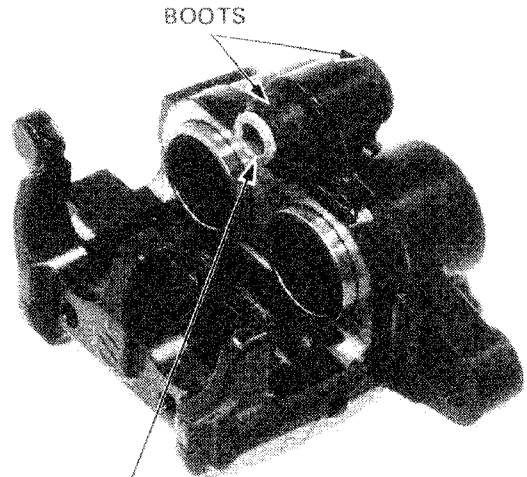

COLLAR

Position the caliper with the piston down and apply
small squirts of air pressure to the fluid inlet.

WARNING

*Do not use high pressure air or bring the
nozzle too close to the inlet.*

NOTE

Place a shop towel over the pistons to prevent
the pistons from becoming projectiles.

Examine the pistons and cylinders for scoring,
scratches or other damage, and replace if necessary.

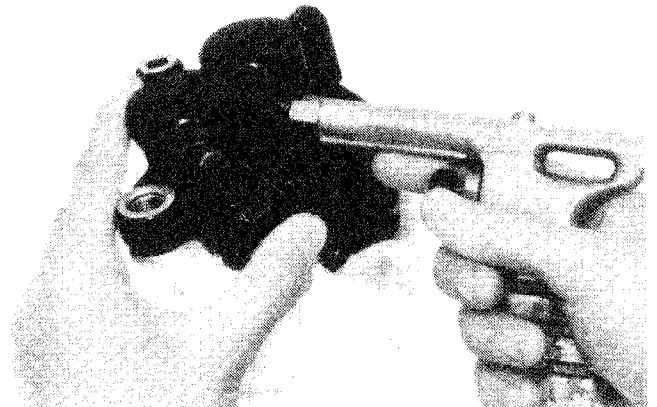



Push the oil seals in and then lift them out.
Clean the oil seal grooves with brake fluid.

CAUTION

Do not damage the piston sliding surfaces.

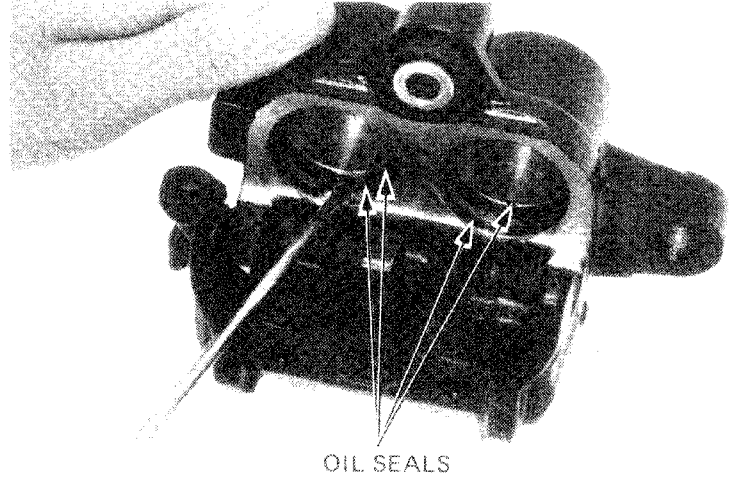

CALIPER PISTON O.D. INSPECTION

Check the piston for scoring, scratches or other faults. Measure the piston diameter with a micrometer.

SERVICE LIMIT: 30.140 mm (1.1866 in)

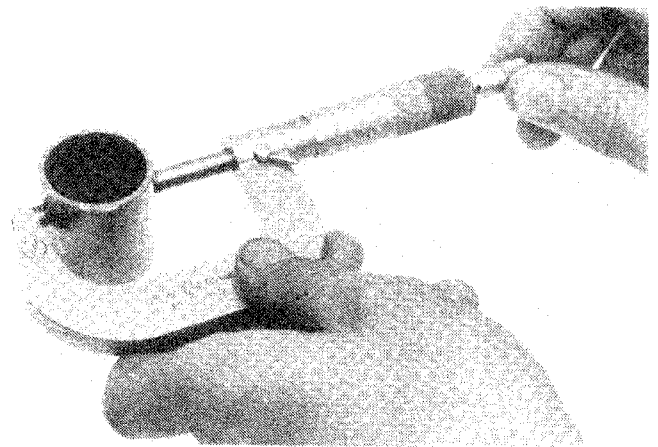

CALIPER CYLINDER I.D. INSPECTION

Check the caliper cylinder for scoring, scratches or other faults. Measure the caliper cylinder bore.

SERVICE LIMIT: 30.290 mm (1.1925 in)

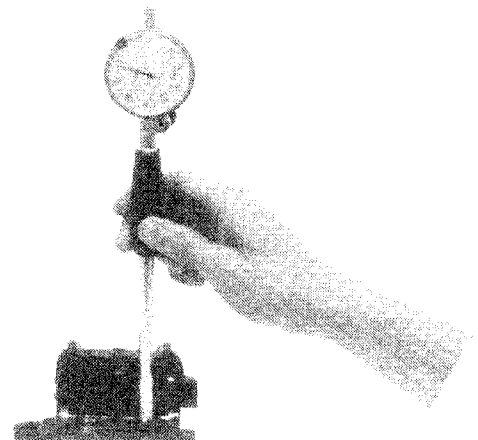



HYDRAULIC DISC BRAKE

CALIPER ASSEMBLY

The oil seals must be replaced whenever the caliper is disassembled.

Coat the oil seals with silicon grease or brake fluid before assembly.

Install the pistons with the dished ends toward the pad side.

Install the boots and collar making sure that the boots are seated in the collar and caliper grooves properly.

Install the anti-rattle spring and the pads.

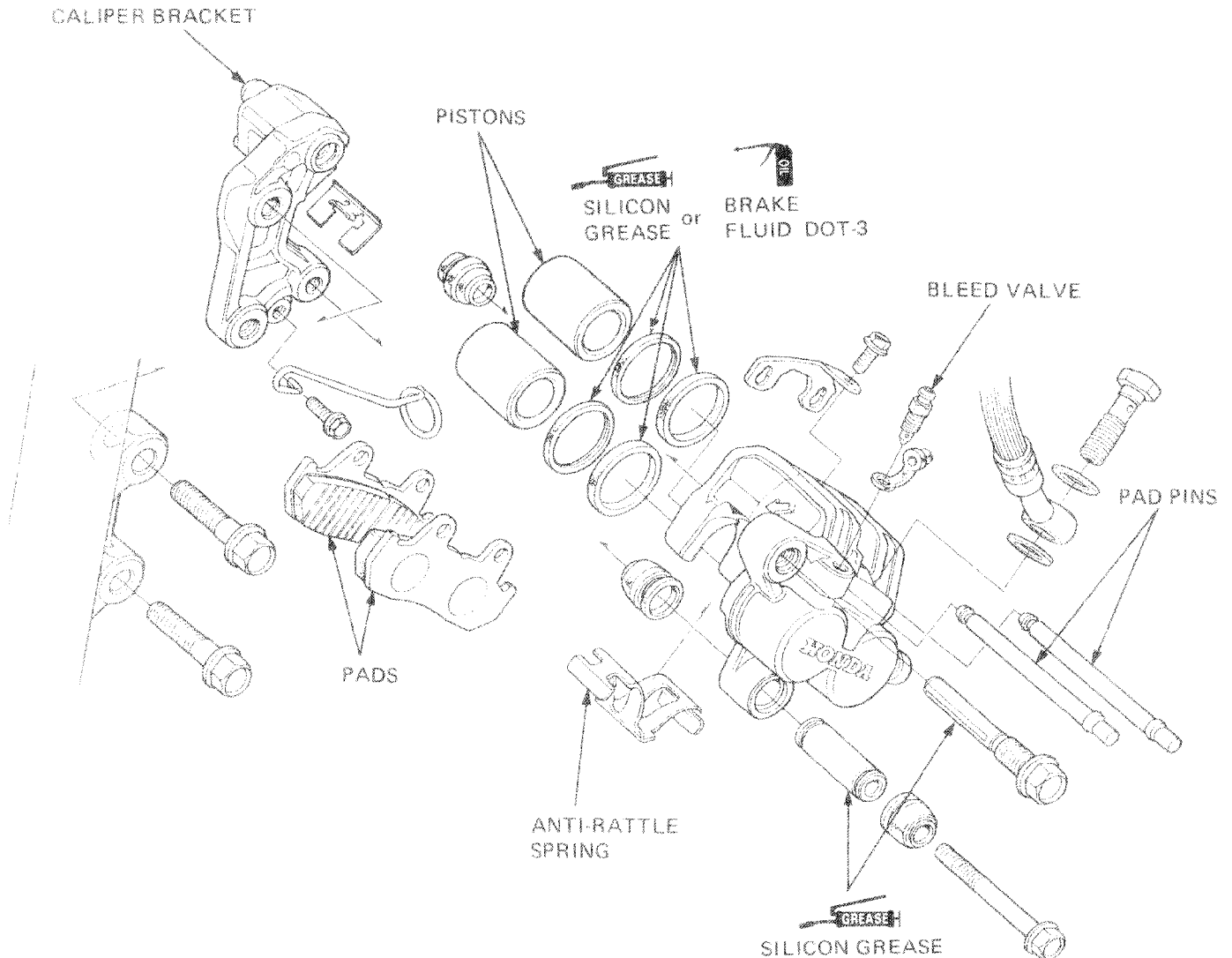
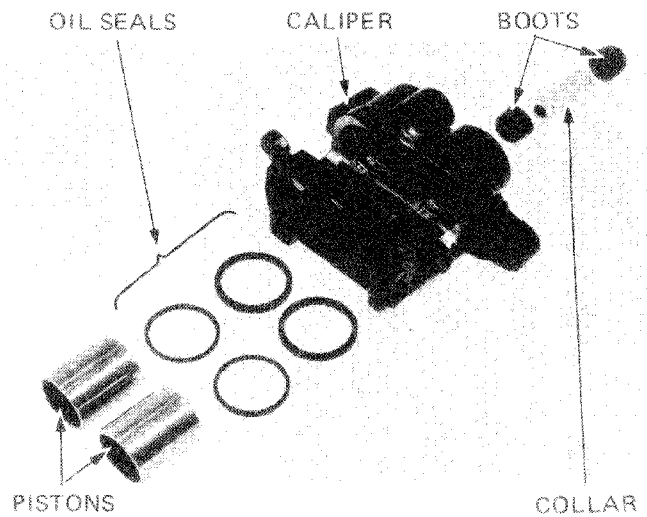



CALIPER INSTALLATION

Inspect the condition of the caliper pivot bolt boot.

Apply silicon grease to the caliper pivot bolt, and collar (Page 15-8).

Install the caliper assembly over the brake disc so that the disc is positioned between the pads.

CAUTION

Be careful not to damage the pads.

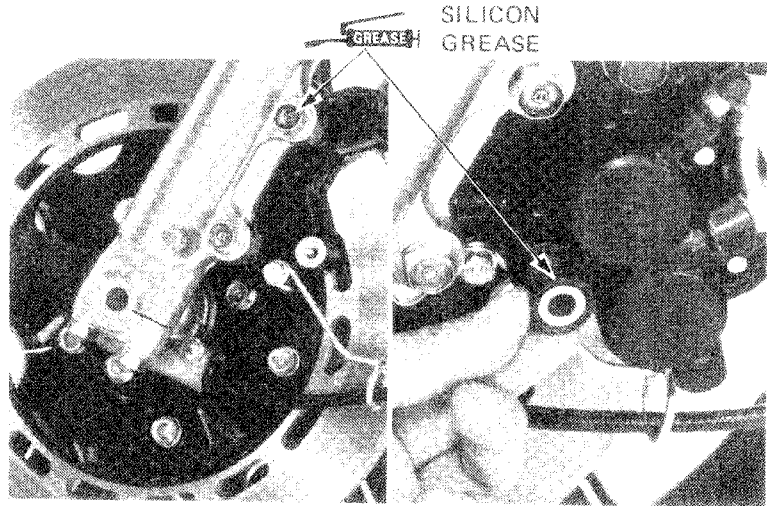

Install the caliper pivot bolt.

TORQUE: 25–30 N·m
(2.5–3.0 kg·m, 18–22 ft·lb)

Install the caliper bolt.

TORQUE: 25–25 N·m
(2.0–2.5 kg·m, 14–18 ft·lb)

Connect the brake hose.

Fill the brake fluid reservoir and bleed the front brake system. (Page 15-2).

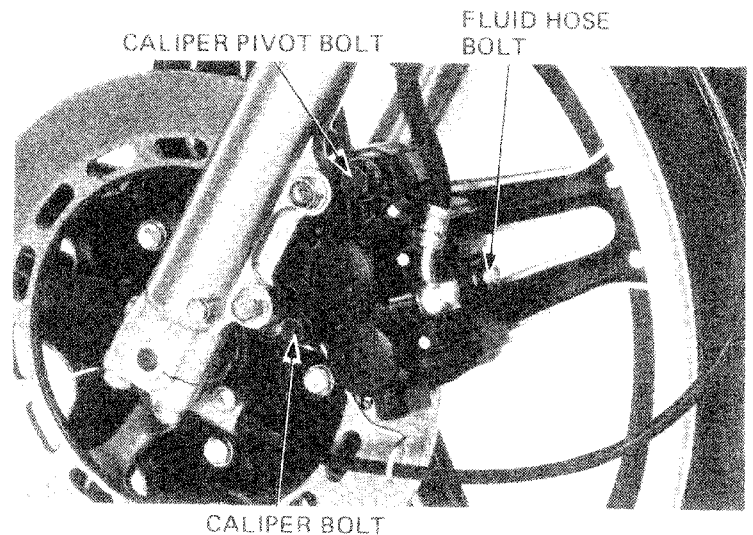

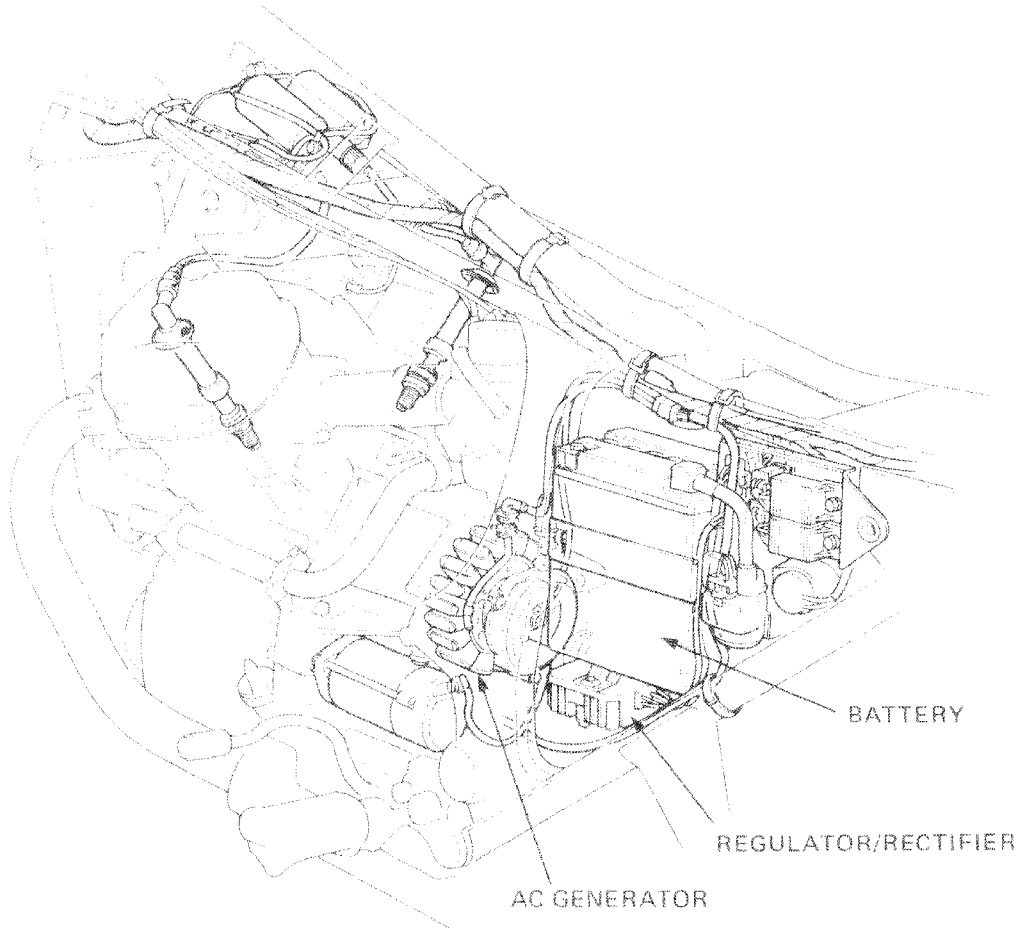

BATTERY CHARGING DIAGRAM

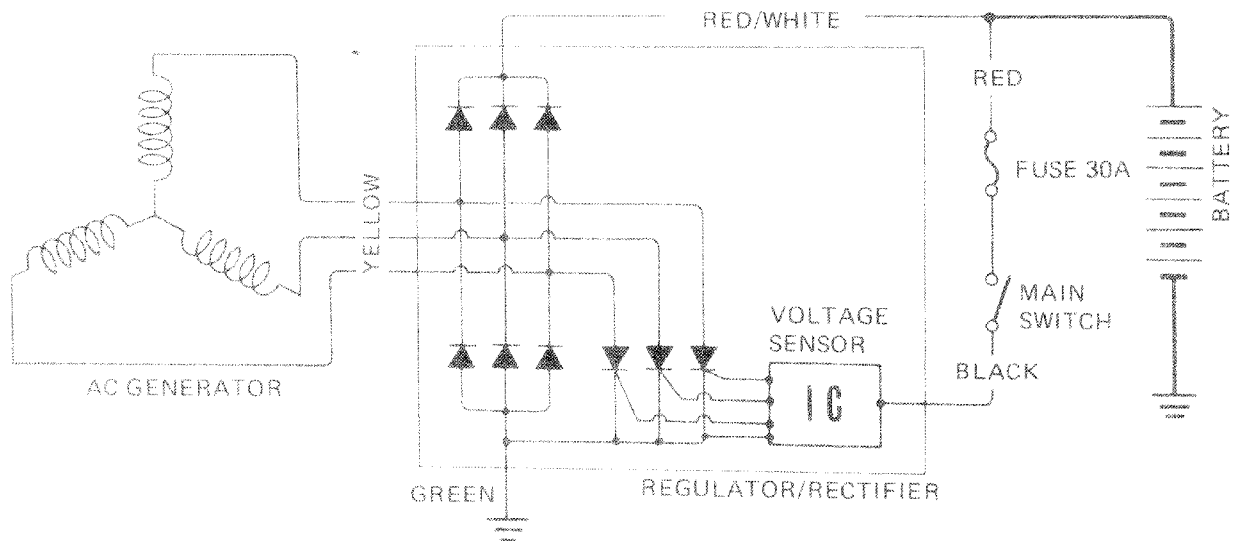



SERVICE INFORMATION	16-1
TROUBLESHOOTING	16-1
BATTERY	16-2
CHARGING SYSTEM	16-3

SERVICE INFORMATION

GENERAL INSTRUCTIONS

- The battery fluid level should be checked regularly. Fill with distilled water as necessary.
- Quick charge the battery only in an emergency. Slow-charging is preferred.
- Remove the battery from the motorcycle for charging. If the battery must be charged on the motorcycle, disconnect the battery cables.

WARNING

Do not smoke or have flames near a charging battery. The gas produced by a battery is highly flammable and can explode.

- For AC generator removal and installation, refer to section 8.
- All charging system components can be tested on the motorcycle.

SPECIFICATIONS

Battery	Capacity	12V, 14 ampere-hours
	Specific gravity	1.28/20°C (68°F)
	Charging rate	1.4 amperes maximum
AC generator	Capacity	High beam: 18 amperes minimum/5,000 rpm (14 volts)
Voltage regulator	Type	Transistorized non-adjustable

TROUBLESHOOTING

No power — key turned on:

1. Dead battery
 - Low fluid level
 - Low specific gravity
 - Charging system failure
2. Disconnected battery cable
3. Main fuse burned out
4. Faulty ignition switch

Low power — key turned On:

1. Weak battery
 - Low fluid level
 - Low specific gravity
 - Charging system failure
2. Loose battery connection

Low power — engine running:

1. Battery undercharged
 - Low fluid level
 - One or more dead cells
2. Charging system failure

Intermittent power:

1. Loose battery connection
2. Loose charging system connection
3. Loose starting system connection
4. Loose connection or short circuit in ignition system
5. Loose connection or short circuit in lighting system

Charging system failure:

1. Loose, broken, or shorted wire or connection
2. Faulty voltage regulator
3. Faulty silicon rectifier
4. Faulty AC generator



BATTERY/CHARGING SYSTEM

BATTERY

REMOVAL

Disconnect the ground cable and remove the battery holder.

Disconnect the positive (+) cable at the battery. Disconnect the battery breather tube, and remove the battery.

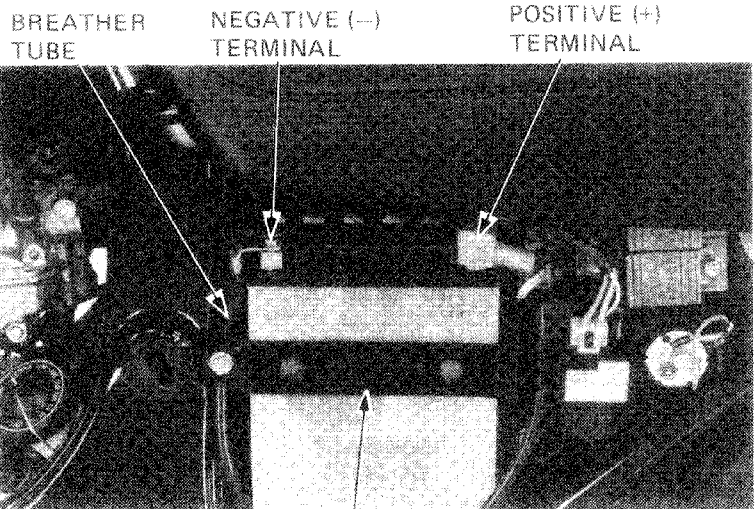

BATTERY HOLDER

TESTING SPECIFIC GRAVITY

Test each cell with a hydrometer.

SPECIFIC GRAVITY: (20° C, 68° F)

1.270–1.290	Fully charged
Below 1.260	Undercharged

NOTE

- The battery must be recharged if the specific gravity is below 1.230.
- The specific gravity varies with the temperature as shown in the table.
- Replace the battery if sulfation is evident or if the space below the cell plates is filled with sediment.

WARNING

The battery contains sulfuric acid. Avoid contact with skin, eyes, or clothing. Antidote: Flush with water and get prompt medical attention.

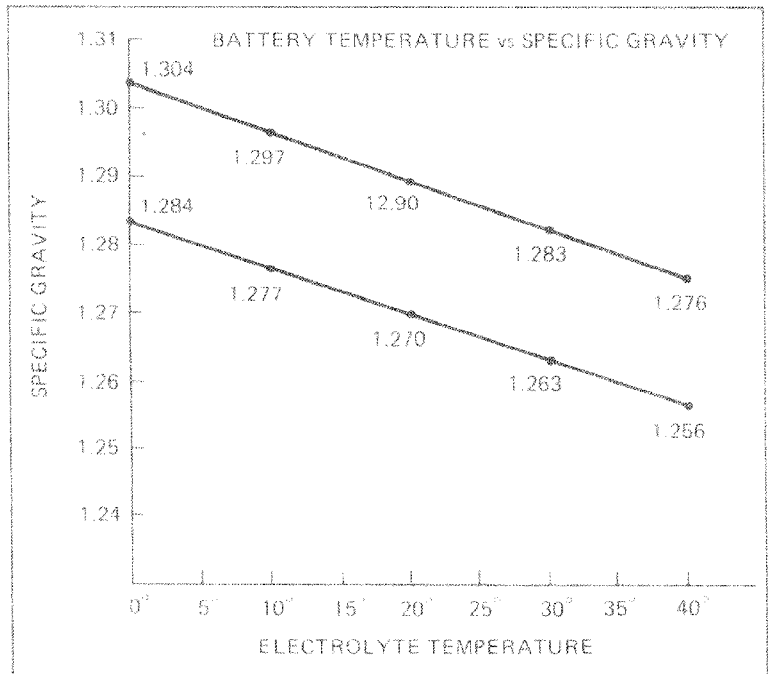
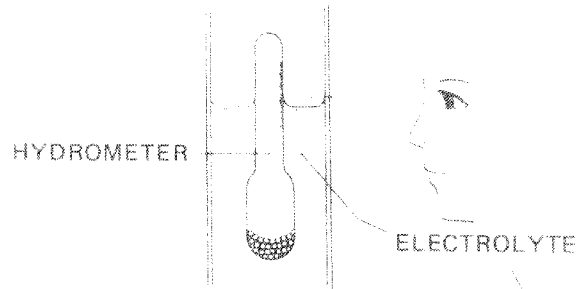

Specific gravity changes by 0.007 for every 10°C.

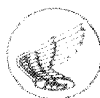

BATTERY CHARGING

Remove the battery cell caps.

Connect the charger positive (+) cable to the battery positive (+) terminal.

Connect the charger negative (-) cable to the battery negative (-) terminal.

Charging current:

1.4 amperes max.

Charging:

Charge the battery until specific gravity is 1.270–1.290 at 20°C (68°F).

WARNING

- Before charging a battery, remove the cap from each cell.
- Keep flames and sparks away from a charging battery.
- Turn power ON/OFF at the charger, not at the battery terminals.
- Discontinue charging if the electrolyte temperature exceeds 45°C (113°F).

CAUTION

Quick-charging should only be done in an emergency; slow-charging is preferred.

After installing the battery, coat the terminals with clean grease before re-connecting the battery cables.

CAUTION

Route the breather tube as shown on the battery caution label.

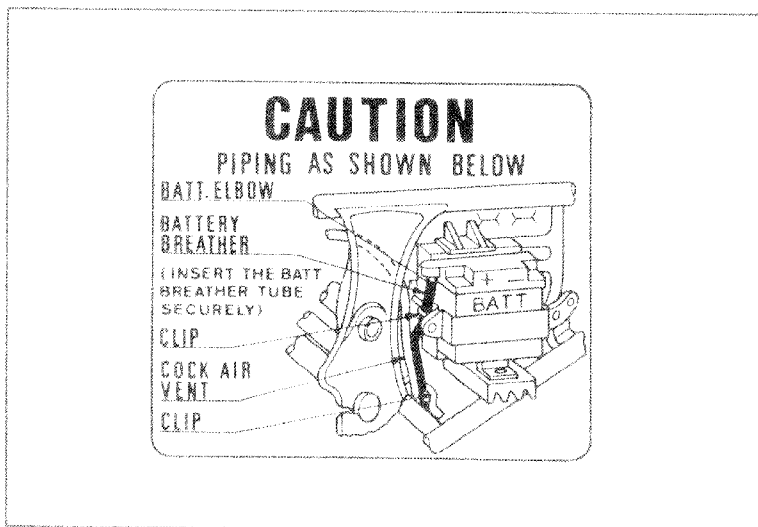
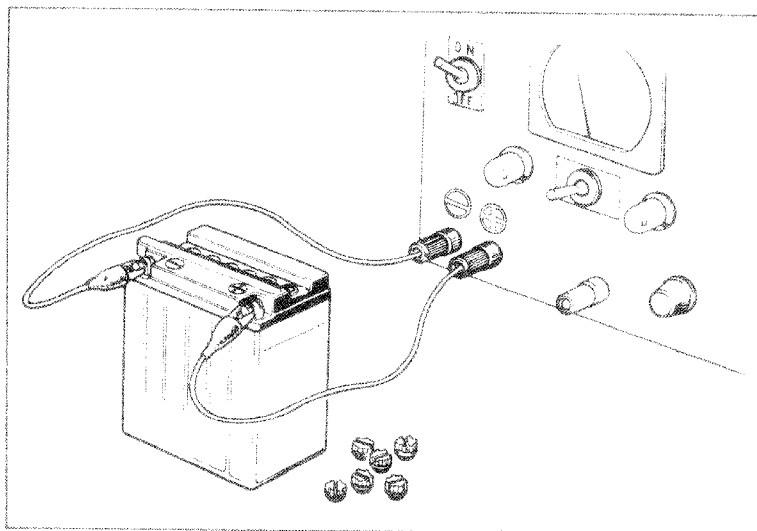

CHARGING SYSTEM

CHARGING OUTPUT TEST

Warm up the engine before taking readings.

Disconnect the main fuse coupler.

Open the main fuse cover and remove the main fuse, then reconnect the coupler.

Connect a voltmeter and ammeter as shown.

NOTE

Use a fully charged battery to check the charging system output.

TECHNICAL DATA:

MAIN SWITCH	LIGHTING SWITCH	CHARGING RPM	5,000 rpm
ON	High beam	1,600 rpm	(5 amperes minimum/14.0 volts)

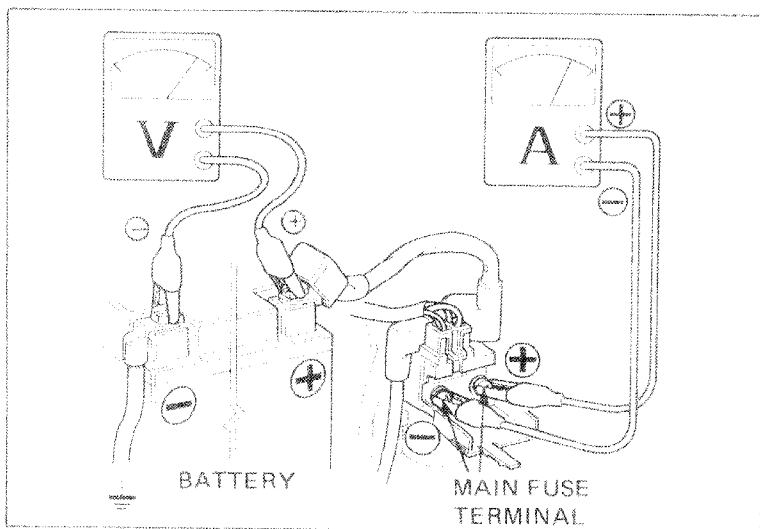



BATTERY/CHARGING SYSTEM

AC GENERATOR WIRE

STATOR COIL CONTINUITY TEST

Check the yellow leads to the AC generator stator for continuity with each other. Replace the stator if any yellow lead is not continuous with the others, or if any lead has continuity to ground. REMOVAL (Page 8-4).

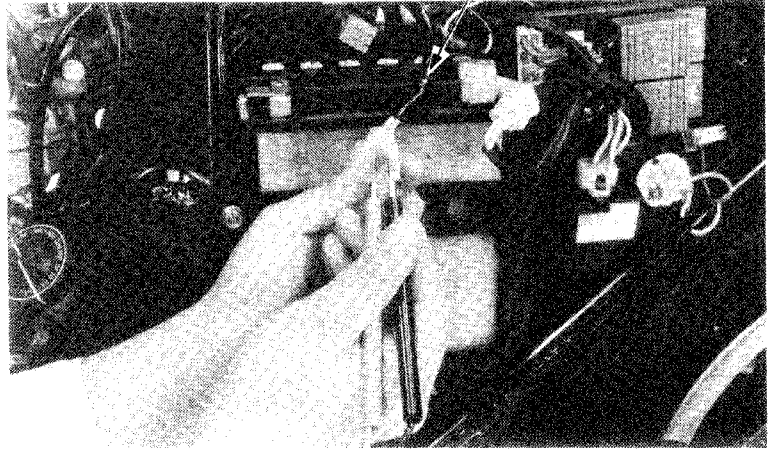

VOLTAGE REGULATOR/RECTIFIER TEST

Check the resistances between the leads with an ohmmeter.

WARNING

Do not use a high voltage source such as insulation resistance tester since it may damage the rectifier and give you a shock.

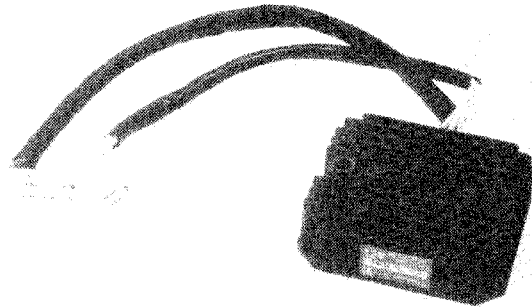

NORMAL DIRECTION: CONTINUITY

	⊕ probe	⊖ probe
I	YELLOW	GREEN
II	RED/WHITE	YELLOW

REVERSE DIRECTION: NO CONTINUITY

	⊕ probe	⊖ probe
I	GREEN	YELLOW
II	YELLOW	RED/WHITE

NOTE

The test results shown are for a positive ground ohmmeter and the opposite results will be obtained when a negative ground ohmmeter is used.

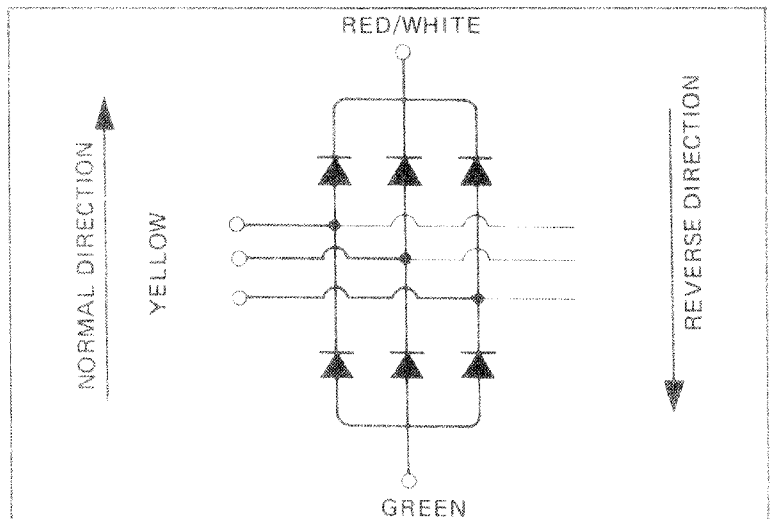



VOLTAGE REGULATOR PERFORMANCE TEST

- a. Testing with a voltmeter
Connect a voltmeter across the battery.
Check regulator performance with the engine running.
The regulator must divert current to ground when battery voltage reaches 14.0 ~ 15.0 V.

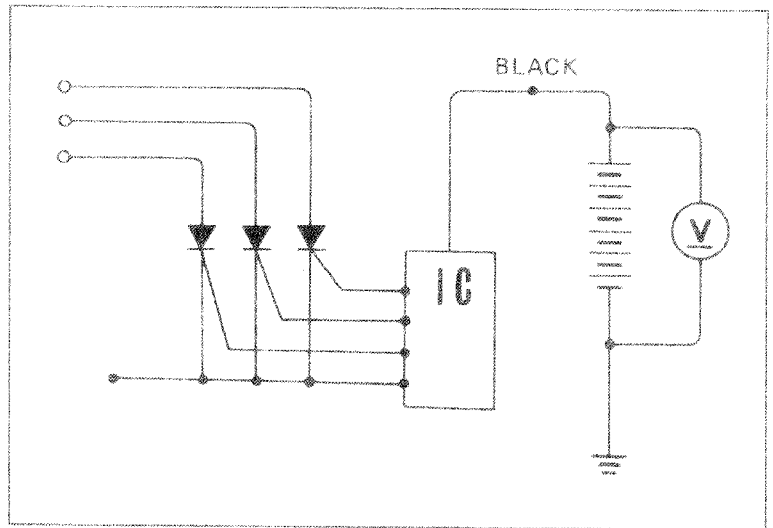

- b. Testing with a variable resistor
Connect a variable resistor (0 ~ 100Ω) across the battery with a 50Ω resistance.
Check for continuity between green and each of three yellow terminals.
The lamp must come on when voltage reads 14 to 15V on the voltmeter by adjusting the variable resistor.

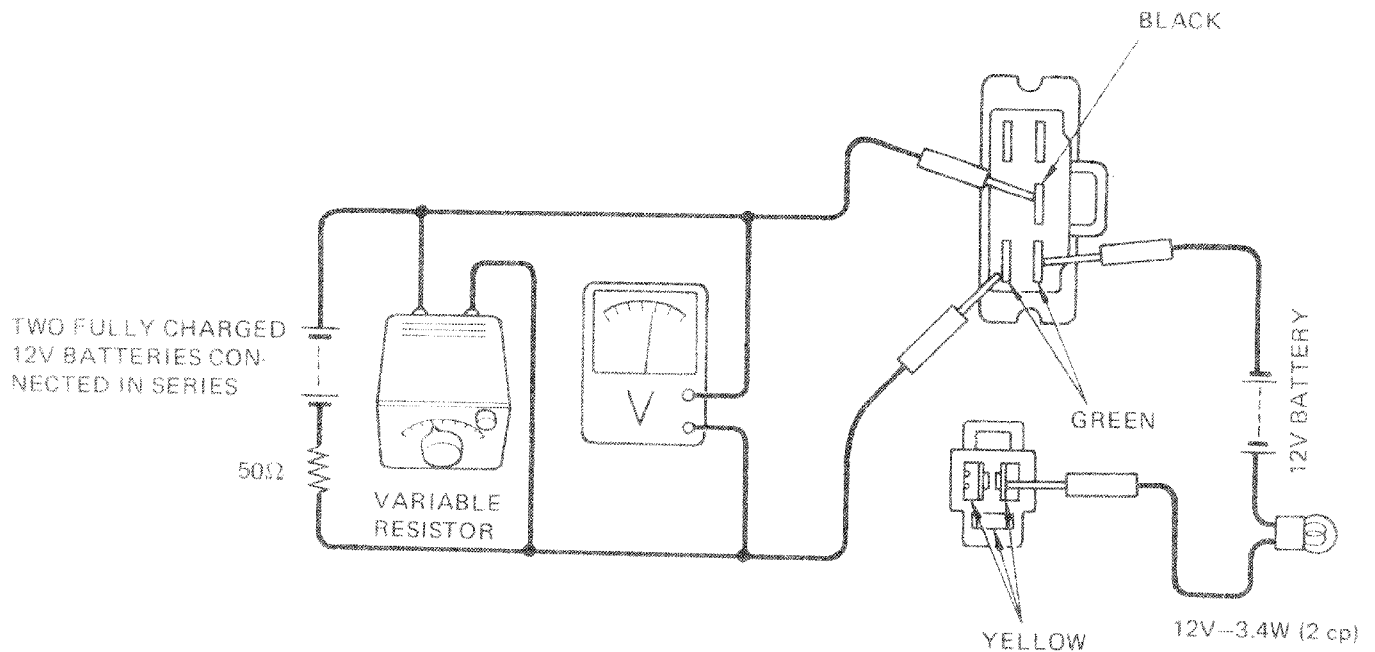



IGNITION SYSTEM

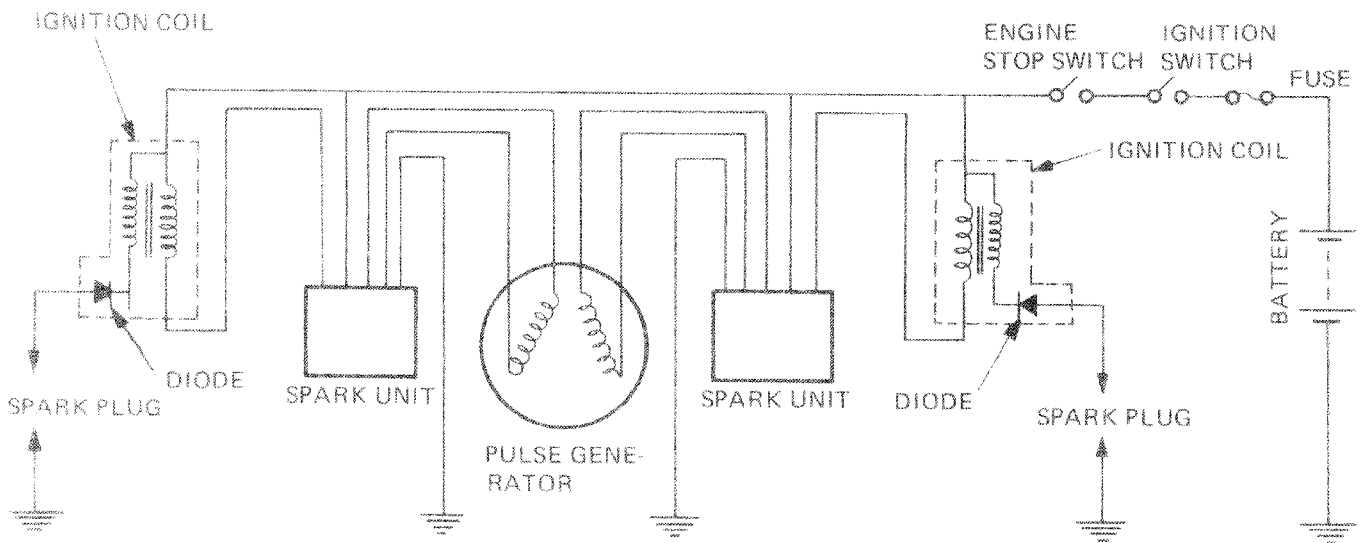
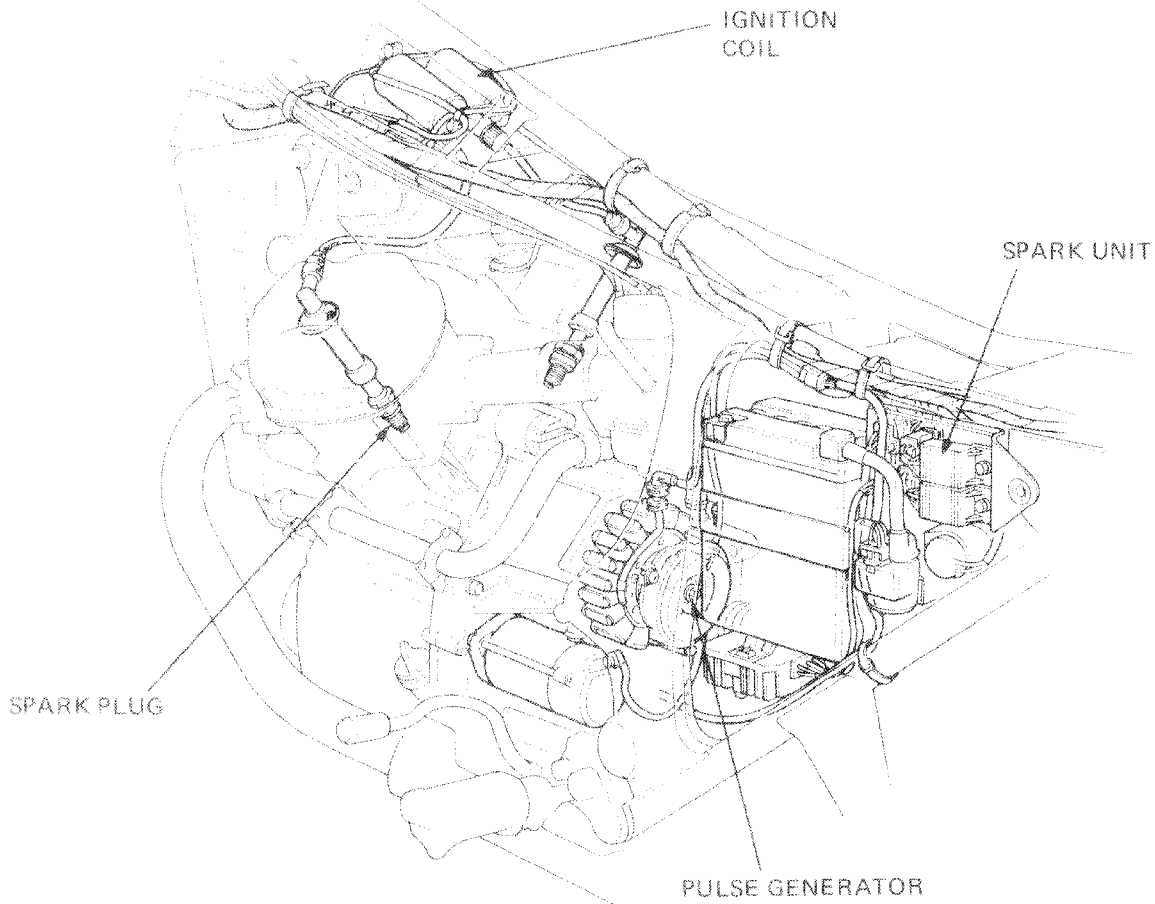



17. IGNITION SYSTEM

SERVICE INFORMATION	17-1
TROUBLESHOOTING	17-1
IGNITION COIL	17-2
TRANSISTORIZED IGNITION SYSTEM (Pulse Generator, Spark Unit)	17-4
SPARK UNIT	17-4
SPARK ADVANCER	17-5
IGNITION TIMING CHECK	17-6

SERVICE INFORMATION

GENERAL INSTRUCTIONS

- A TRANSISTORIZED IGNITION SYSTEM is used and no adjustments are to be made unless the pulse generator screws are loosened or the pulse generator is removed.
- To adjust the ignition timing, see Page 8-10.
- For spark plug information, see Page 3-7.

SPECIFICATIONS

RECOMMENDED SPARK PLUG

	GL500 GL500I		With optional radio (GL500I)	
	Standard	For extended high speed riding	For normal condition	For extended high speed riding
NGK	D8EA	D9EA	DR8ES-L	DR8ES
ND	X24ES-U	X27ES-U	X24ESR-U	X27ESR-U

- Spark plug gap: 0.6–0.7 mm (0.02–0.03 in)
 Ignition timing: "F" mark: 15° BTDC at 1,100 rpm
 Full advance: 45 ± 1.5° BTDC at 3,000 rpm
 Pulse generator air gap: 0.45–0.65 mm (0.018–0.026 in)
 Ignition coil: 3-point spark test 6 mm (1/4 in) minimum

TROUBLESHOOTING

Engine cranks but will not start

- Engine stop switch OFF.
- No spark at plugs
- Faulty transistorized spark unit
- Faulty pulse generator
- Faulty ignition coil
- Faulty ignition switch
- Faulty spark unit
- Faulty pulse generator

No spark at plug

- Engine stop switch OFF
- Poorly connected, broken or shorted wires
 - Between ignition switch and engine stop switch
 - Between spark unit and engine stop switch
 - Between spark unit and ignition coil
 - Between ignition coil and plug
 - Between spark unit and pulse generator

Engine starts but runs poorly

- Ignition primary circuit
 - Faulty ignition coil
 - Loose or bare wire
 - Intermittent short circuit
- Secondary circuit
 - Faulty plug
 - Faulty high tension cord

Timing advance incorrect

- Centrifugal advancer faulty

IGNITION SYSTEM

IGNITION COIL

REMOVAL

Remove the fuel tank.
Disconnect the ignition switch couplers.
Remove the coil by removing the attaching bolts.

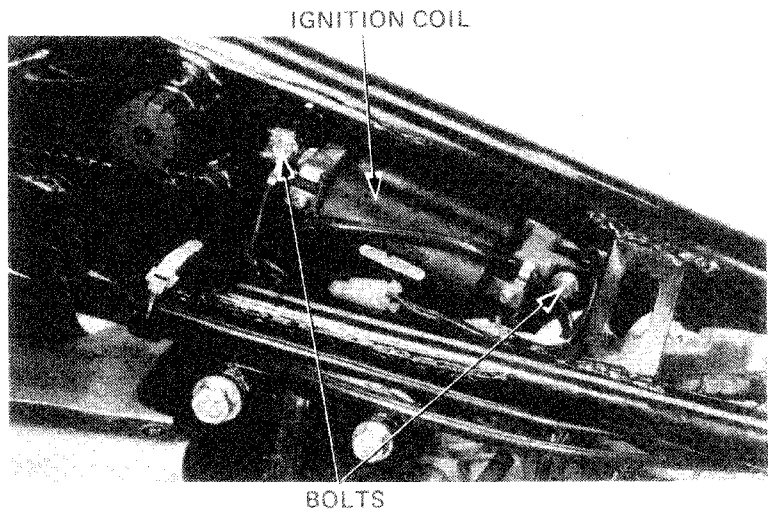

PERFORMANCE TEST

Perform the 3-point spark test with a coil tester.
SERVICE LIMIT: 6 mm (1/4 in) min

NOTE

Follow the coil tester manufacturer's instructions.

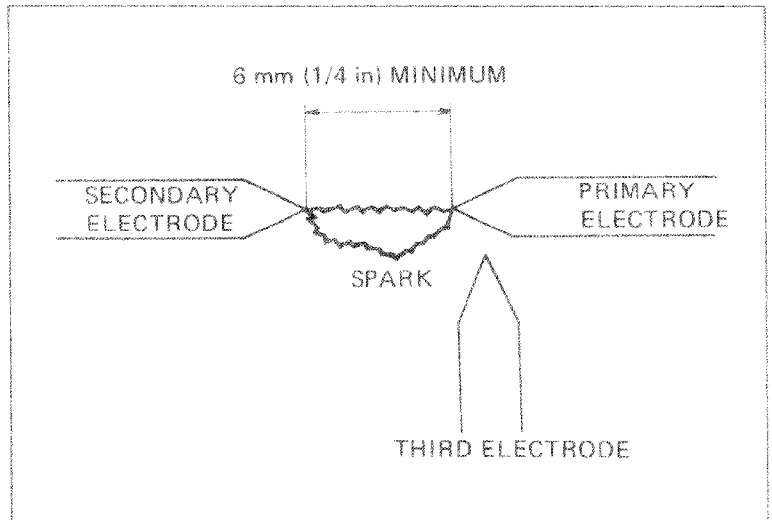

PRIMARY COIL INSPECTION

Check the resistance between the leads with an ohmmeter as shown.

RESISTANCE: 2-3Ω

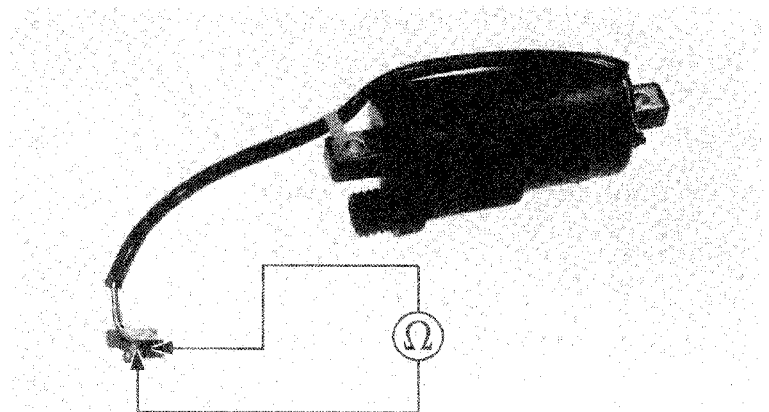



SECONDARY COIL INSPECTION

NOTE

The secondary coil inspection method differs depending on whenever or not there is a mark on the ignition coil body. Look for an "S" mark before testing.

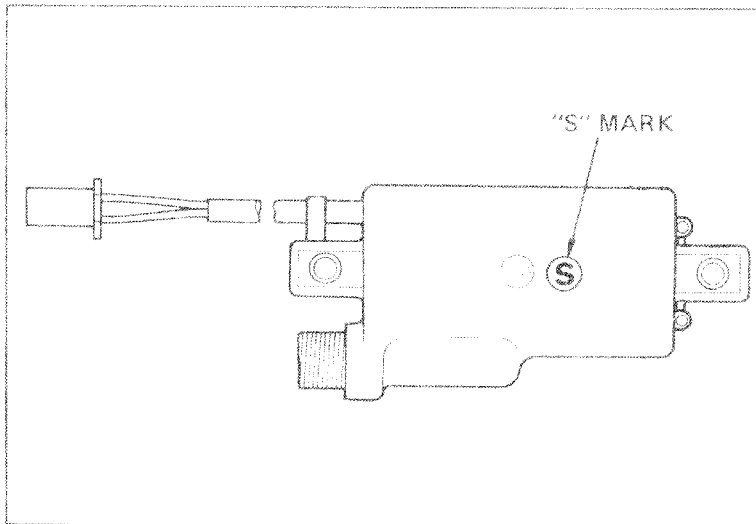

WITH "S" MARK

Measure the resistance between the black/white coupler terminal and the high tension cord terminal.

NOTE

- Use SANWA TESTER (07308-0020000) or KOWA TESTER (TH-5H).
- Use new test batteries for this test.

1. Connect the negative probe of the tester to the coupler terminal and positive probe to the high tension terminal and measure the resistance.

RESISTANCE:

SANWA TESTER: 200-350 kΩ

KOWA TESTER: 50-200 kΩ

2. Change the tester polarities and measure the resistance.

RESISTANCE: ∞ ohms

Replace the ignition coil if the resistance of test 1 and/or 2 exceeds the limit.

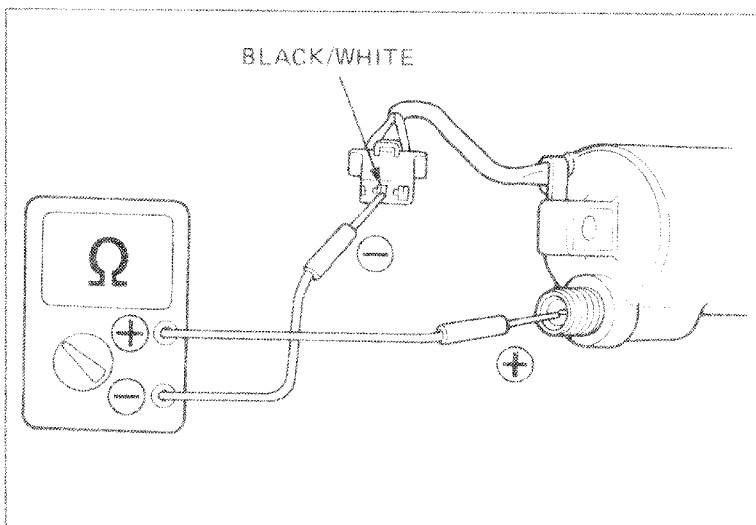

WITHOUT "S" MARK

Connect the ignition coil, tester and two 12V batteries as shown in the figure.

NOTE

Make sure the battery voltage is 23-25V before measuring.

Replace the ignition coil if the reading does not meet the specification.

Tester	Measuring range	Specification
SANWA	25 mA	Approximately 3 mA
KOWA	100 mA	Needle should swing slightly.

Change the tester polarities.

Replace the ignition coil if there is continuity.

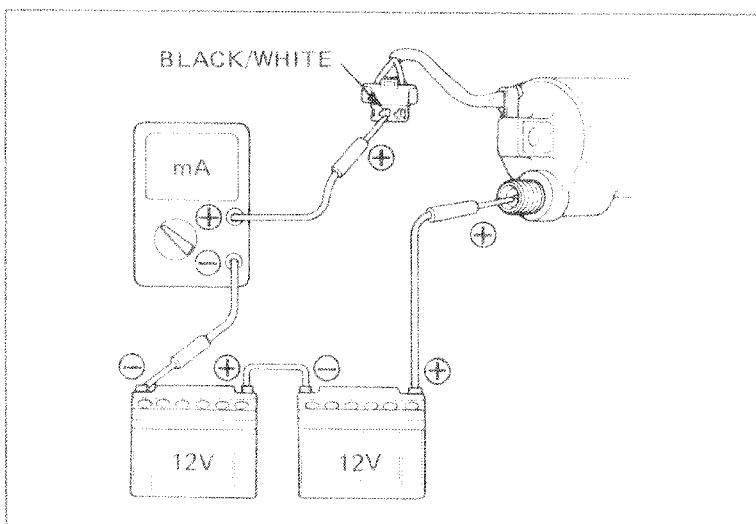



IGNITION SYSTEM

TRANSISTORIZED IGNITION SYSTEM

INSPECTION

Remove the swingarm (Page 14-16).
Remove the pulse generator cover.
Disconnect the spark plugs.
Hold each plug against any convenient engine ground.
Turn the ignition switch on.
Touch the end of a screwdriver to one pulse generator steel core.
A good spark to the plug means that the ignition system for that cylinder is in good shape.
Repeat the above for the other pulse generator.

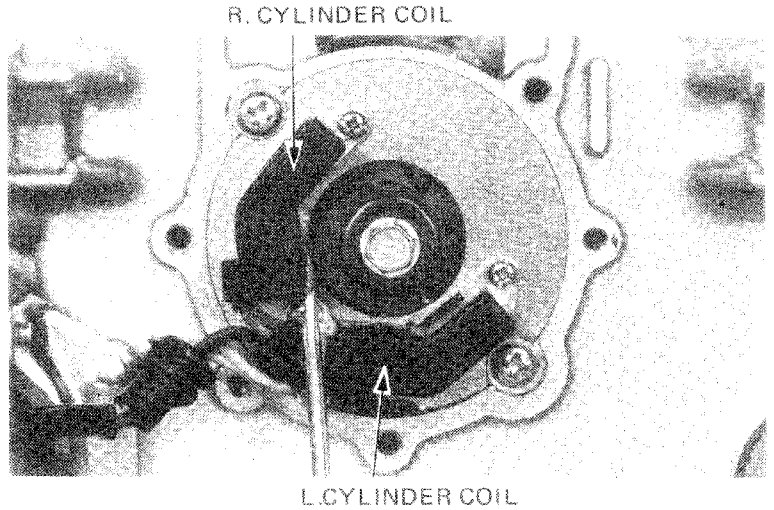

Measure the coil resistance.
COIL RESISTANCE: $530 \pm 50\Omega$ (20°C, 68°F)
Between yellow with white tube and yellow leads (Right cylinder)
Between blue with white tube and blue leads (Left cylinder)

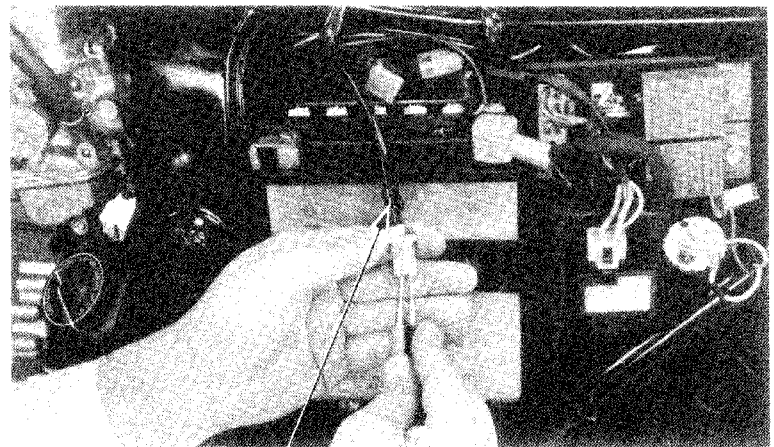

PULSE GENERATOR WIRE

SPARK UNIT

Disconnect the wires at the pulse generator coupler.

Attach the positive lead of a voltmeter to the blue with yellow tube wire terminal (L) or yellow with white tube wire terminal (R) of the 6-pole coupler.
Attach the negative lead to any convenient ground.
Turn the ignition switch on.

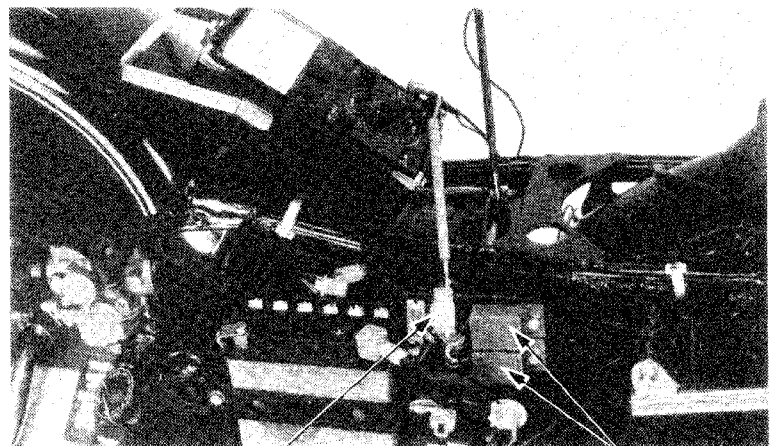

6-POLE COUPLER

SPARK UNITS



Ground each corresponding terminal (L: blue with white tube wire terminal, R: yellow with white tube wire terminal) of the 4-pole coupler intermittently.

The transistor unit is normal if the voltage indicated by the voltmeter changes from 12V to 0V in each test.

PULSE GENERATOR COUPLER
(WIRE HARNESS SIDE)

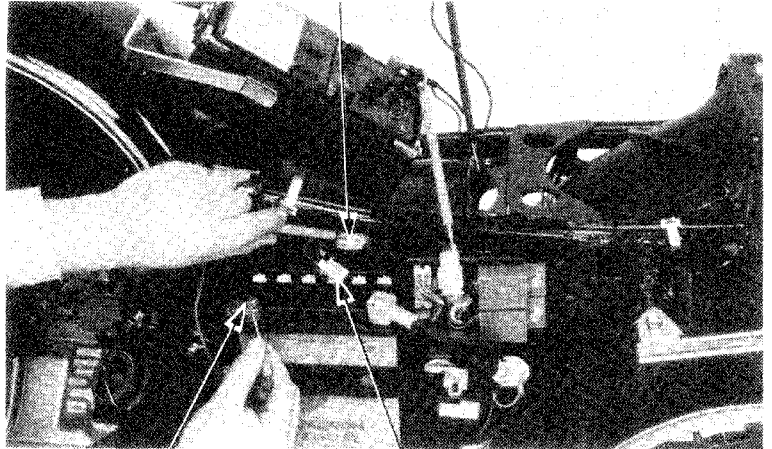

BATTERY
GROUND

PULSE GENERATOR
COUPLER

SPARK ADVANCER

Remove the pulse generator (Page 8-3).
Check the mechanical advancer cam for sticking.
Lubricate the sliding surfaces, and check the spring for loss of tension and advancer pin for excessive wear.

NOTE

Align the rotor tooth with the cut-out of the advancer when assembling.

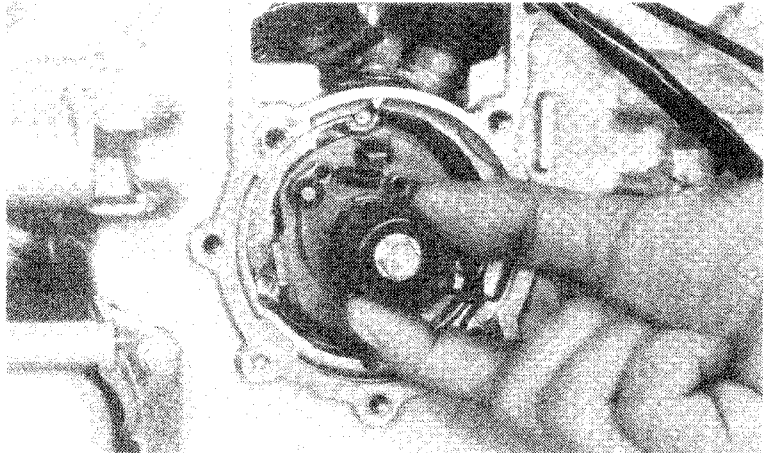

Install the spark advancer.
Install the pulse generator and adjust the ignition timing (Page 8-10).

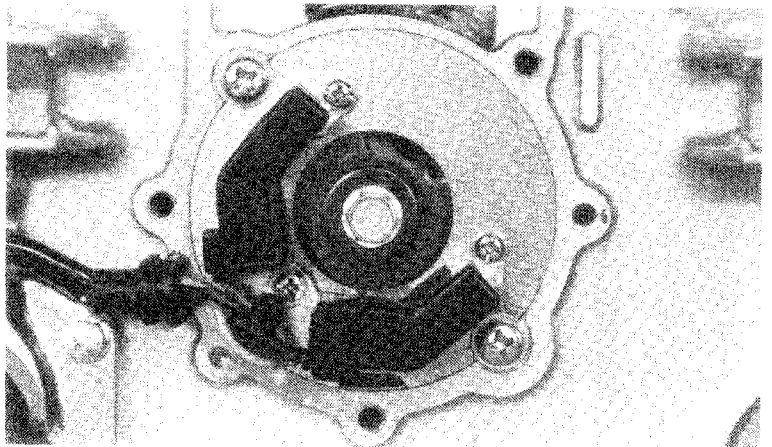



IGNITION SYSTEM

PULSE GENERATOR AIR GAP ADJUSTMENT

Measure the air gaps between the pulse generators and the rotor tooth.

AIR GAP: 0.45–0.65 mm (0.018–0.026 in)

When adjustment is necessary, loosen the pulse generator coil attaching screws and move the coil to achieve the correct gap.

Recheck the ignition timing.

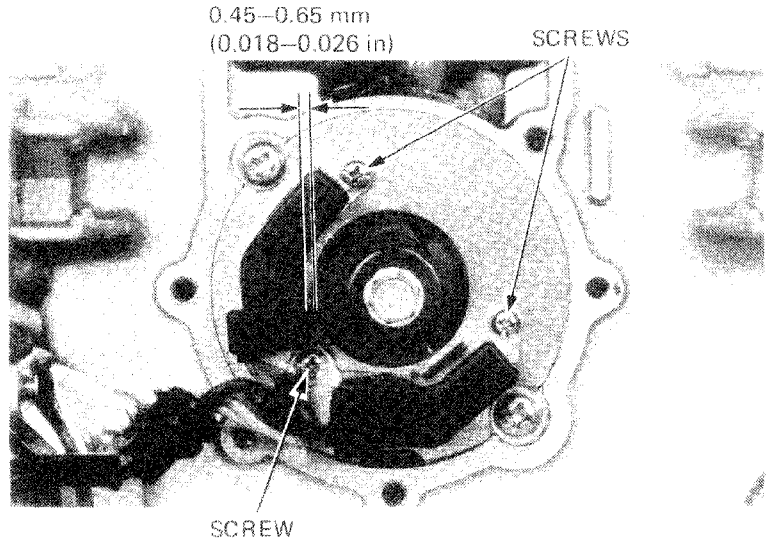

IGNITION TIMING CHECK

Remove the timing hole cap and install the timing inspection plug.

Connect a timing light to the right cylinder.

Connect a tachometer.

Start the engine and check the ignition timing:

At 1,100 ± 100 rpm:

The index mark should be aligned with the FI mark.

At 1,500 ± 100 rpm:

Timing advance should start.

At 3,000 ± 150 rpm:

Timing advance should cease.

The index mark should be between the full advance marks.

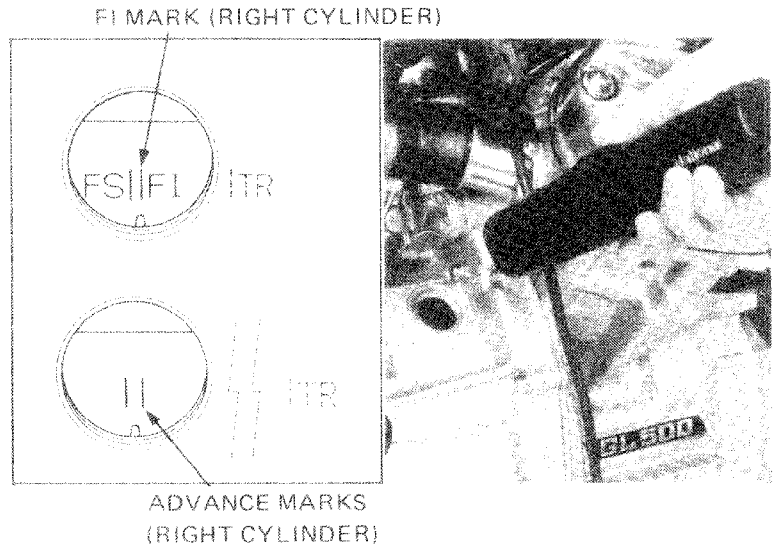

Check the left cylinder using the FI mark and the full advance marks.

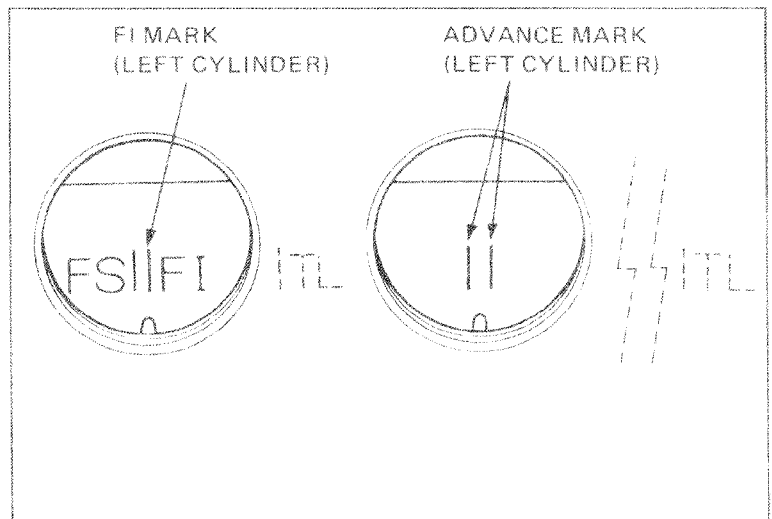



HONDA
GL500
GL500 INTERSTATE

MEMO



STARTER SYSTEM

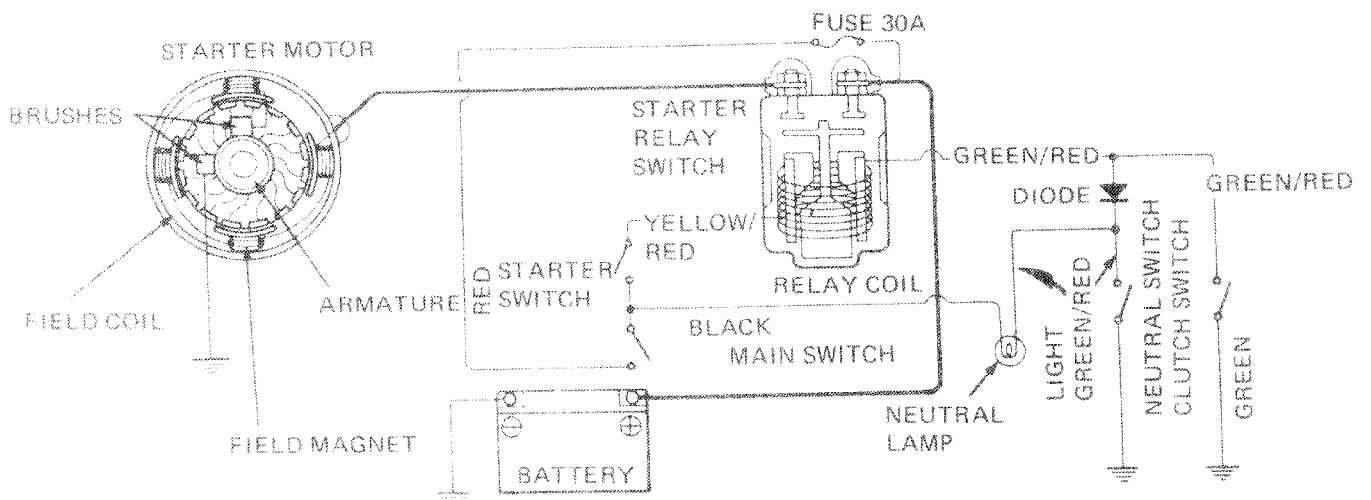
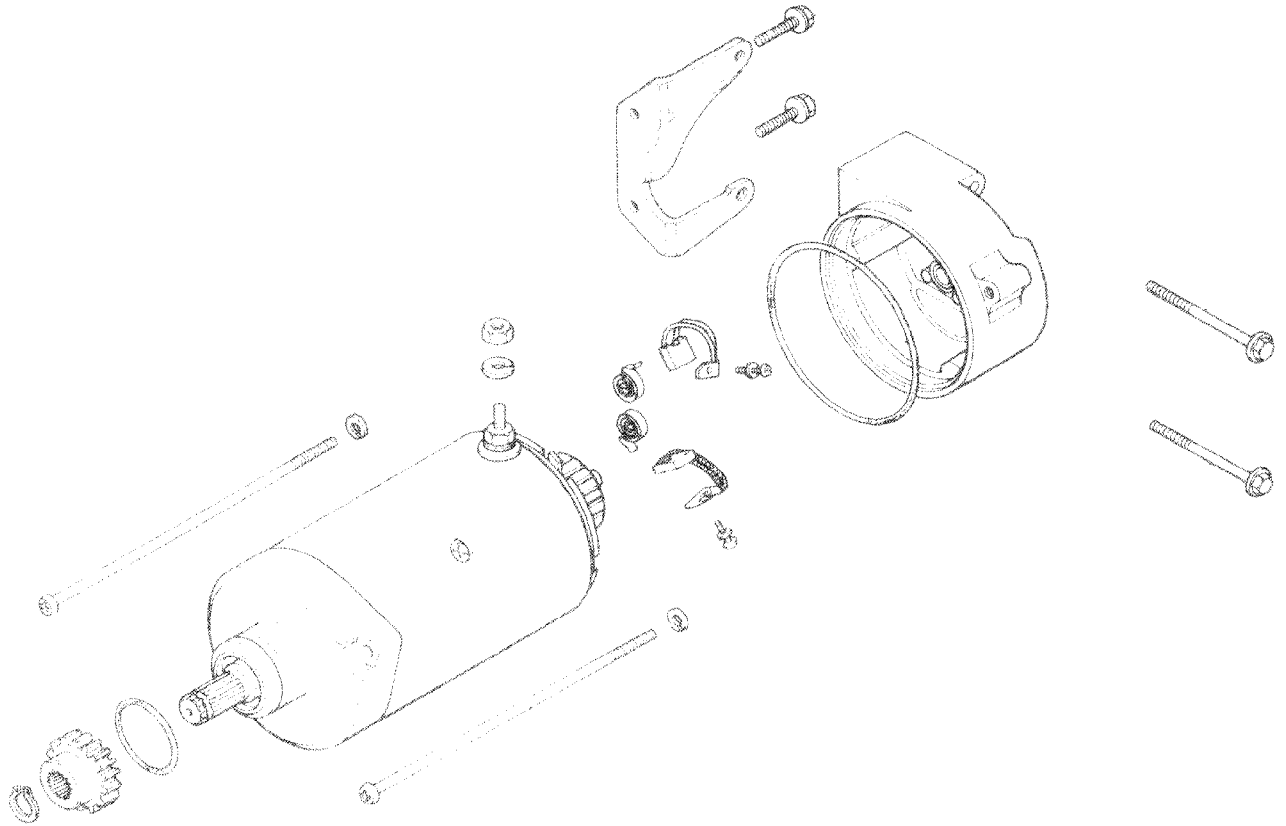



18. STARTER SYSTEM

SERVICE INFORMATION	18-1
TROUBLESHOOTING	18-1
STARTER MOTOR	18-2
RELAY SWITCH	18-4
SILICONE RECTIFIER	18-4

SERVICE INFORMATION

GENERAL INSTRUCTION

The starter motor can be removed with the engine in the frame. Starter clutch repairs (Page 8-5).

SPECIFICATIONS

Item		Standard	Service Limit
Starter motor	Brush spring tension	0.495-0.605 kg	400 g
	Brush length	11.0-12.5 mm (0.43-0.49 in)	5.5 mm (0.21 in.)

TROUBLESHOOTING

Starter Motor Will Not Turn:

1. Dead battery
2. Faulty ignition switch
3. Faulty starter switch
4. Faulty neutral switch
5. Faulty starter relay switch
6. Loose or disconnected wire or cable
7. Neutral diode open
8. Faulty clutch switch

Starter Motor Turns Engine Slowly:

1. Low battery
2. Excessive resistance in circuit
3. Binding in starter motor

Starter Motor Turns, But Engine Does Not Turn:

1. Faulty starter clutch
2. Faulty starter motor gears
3. Faulty starter motor or idle gear

Starter Motor and Engine Turn, But Engine Does Not Start:

1. Faulty ignition system
2. Engine problems
3. Faulty engine stop switch



STARTER SYSTEM

STARTER MOTOR

REMOVAL

WARNING

With the ignition switch OFF, remove the negative cable at the battery before servicing the starter motor.

Remove the starter mounting bolts and pull the motor out of the engine case.
Disconnect the starter cable.

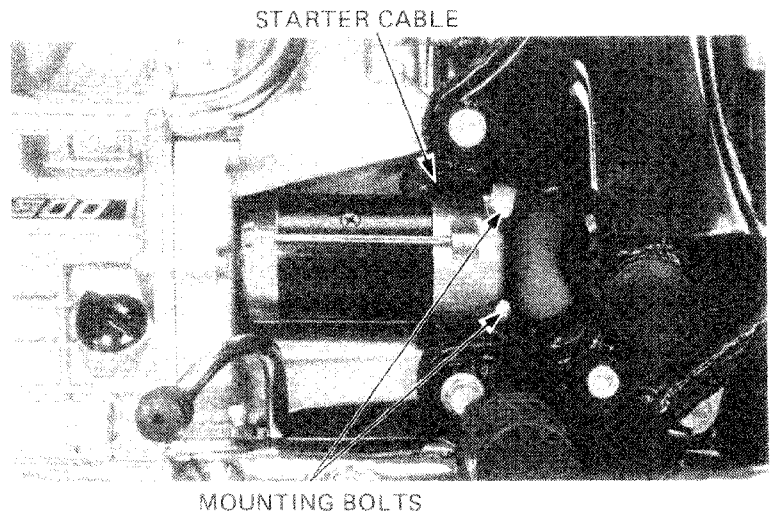

BRUSH INSPECTION

Remove the starter motor case screws. Inspect the brushes and measure brush length. Measure brush spring tension with a spring scale.

SERVICE LIMITS:

Brush length: 5.5 mm (0.21 in)

Brush spring tension: 400 g

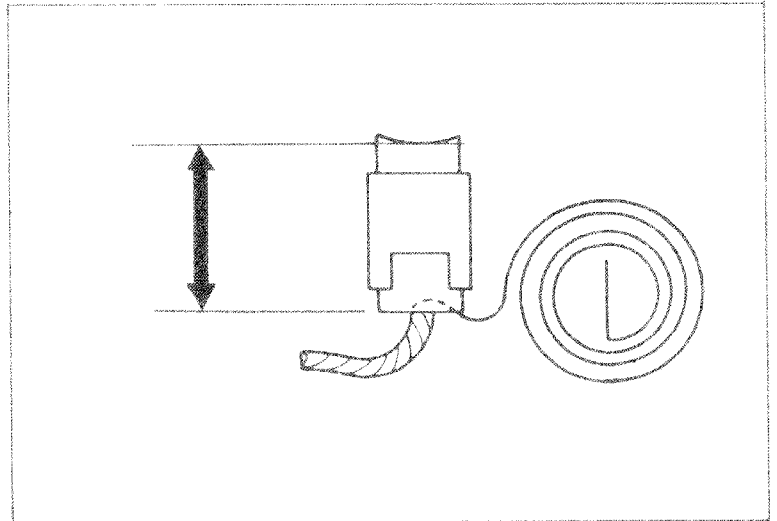

COMMUTATOR INSPECTION

Remove the case.

NOTE

Record the location and number of the thrust washers.

Inspect the commutator bars for discoloration. Bars discolored in pairs indicate grounded armature coils.

NOTE

Do not use emery or sand paper on the commutator.

COMMUTATOR

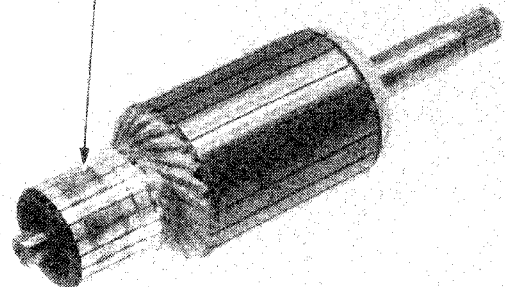



Check for continuity between pairs of commutator bars, and also between commutator bars and armature shaft.

Replace starter motor if armature coils are open, or shorted to armature shaft.

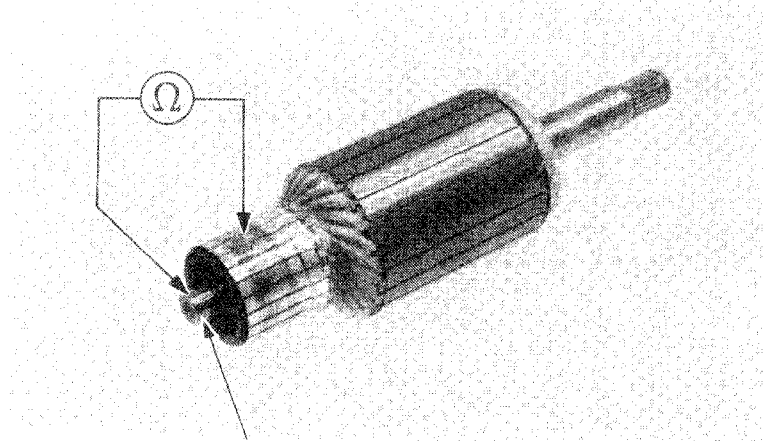

ARMATURE SHAFT

FIELD COIL INSPECTION

Check for continuity from the cable terminal to the motor case and from the cable terminal to the brush wire.

Replace the starter motor if the field coil is not continuous or if it is shorted to the motor case.

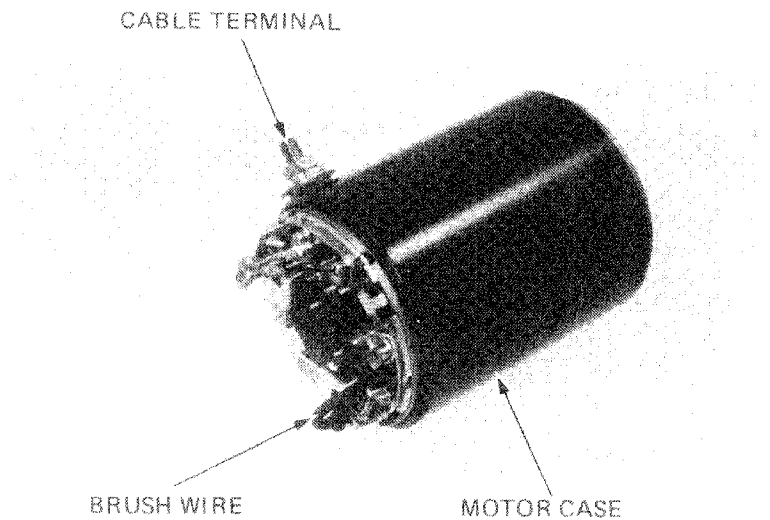

BRUSH WIRE

MOTOR CASE

ASSEMBLY/INSTALLATION

Assemble the starter motor.

NOTE

Align the punch mark on the case to the punch mark on the cover.

Connect the starter motor cable.
Install the starter motor on the engine.

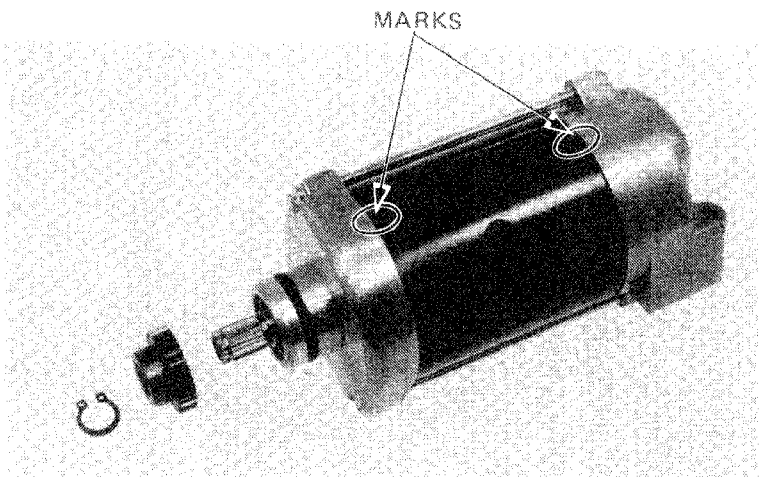



STARTER SYSTEM

RELAY SWITCH

INSPECTION

To test if the switch primary coil is normal, depress the switch button. The coil is normal if the switch clicks into position.

Connect an ohmmeter and 12V battery to the starter relay switch as shown. The switch is normal if there is continuity.

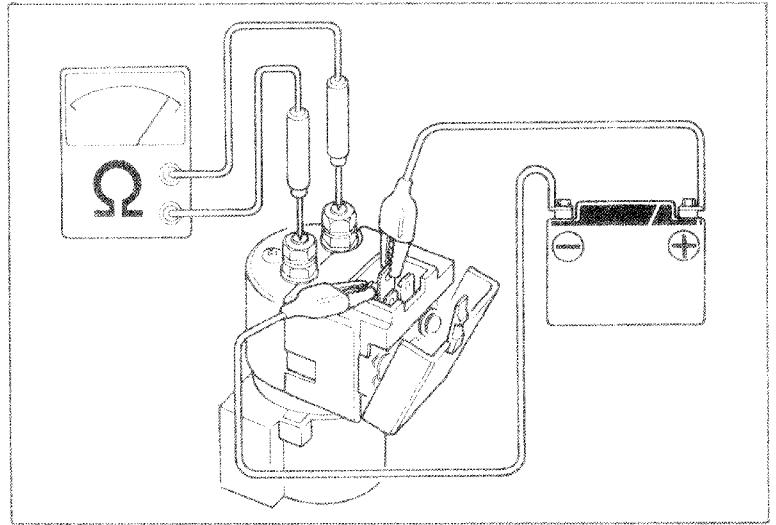

SILICONE RECTIFIER

INSPECTION

Remove the left side cover and remove the silicone rectifier from the wire harness. Check for continuity with an ohmmeter.

NORMAL DIRECTION: CONTINUITY

⊕ probe: Light green/Red (+)

⊖ probe: Green/Red (-)

REVERSE DIRECTION: NO CONTINUITY

⊕ probe: Green/Red (-)

⊖ probe: Light green/Red (+)

NOTE

The test chart is for a positive ground ohmmeter. The test results will be reversed if a negative ground ohmmeter is used.

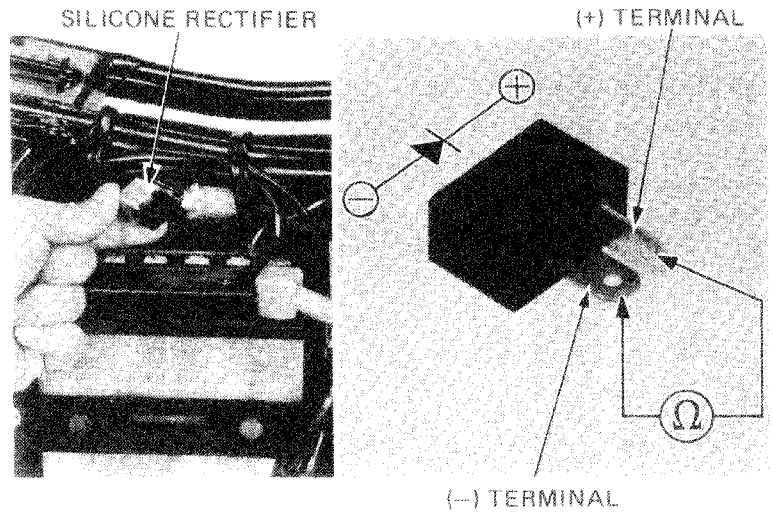



19. LIGHTS/SWITCHES

SERVICE INFORMATION	19-1	CLUTCH SWITCH	19-4
OIL PRESSURE WARNING SWITCH	19-2	IGNITION SWITCH	19-5
BRAKE SWITCHES	19-2	TEMPERATURE GAUGE	19-7
NEUTRAL SWITCH	19-2	AUXILIARY VOLTAGE REGULATOR INSPECTION	19-7
HANDLEBAR SWITCHES	19-3	BULB REPLACEMENT	19-8

SERVICE INFORMATION

GENERAL INSTRUCTIONS

- Some wires have different colored bands around them near the connector. These are connected to other wires which correspond with the band color.
- All plastic plugs have locking tabs that must be released before disconnecting, and must be aligned when reconnecting.
- The following color codes used are indicated throughout this section and on the wiring diagram.

Bu = Blue	G = Green	Lg = Light Green	R = Red
Bl = Black	Gr = Grey	O = Orange	W = White
Br = Brown	Lb = Light Blue	P = Pink	Y = Yellow

- To isolate an electrical failure, check the continuity of the electrical path through the part. A continuity check can usually be made without removing the part from the motorcycle. Simply disconnect the wires and connect a continuity tester or volt-ohmmeter to the terminals or connections.
- A continuity tester is useful when checking to find out whether or not there is an electrical connection between the two points. An ohmmeter is needed to measure the resistance of a circuit, as when there is a specific coil resistance involved, or when checking for high resistance by corroded connections.



OIL PRESSURE WARNING SWITCH

Check for continuity while applying pressure to the switch.

Continuity: Below 20 kPa (0.2 kg/cm², 2.8 psi)

No continuity: Above 20–40 kPa
(0.2–0.4 kg/cm², 2.8–5.6 psi)

Replace the switch if necessary.

Apply a liquid sealant to the switch threads.

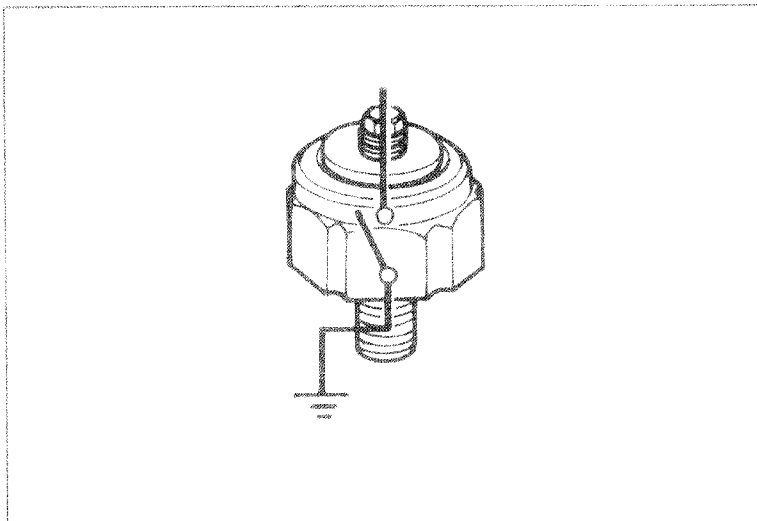

BRAKE SWITCHES

Check the rear brakelight switch for continuity with the rear brake applied.

Check the front brakelight switch for continuity with the front brake applied.

Replace the switches if necessary.

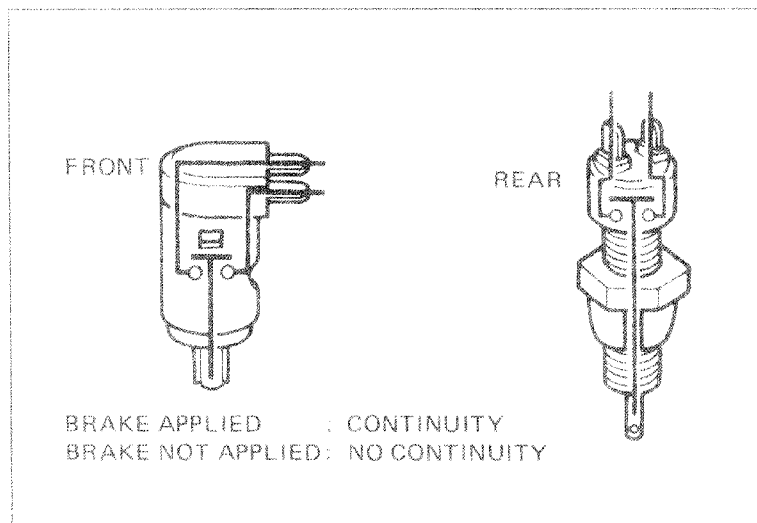

NEUTRAL SWITCH

NOTE

Refer to page 8-4, for neutral switch removal.

Check the neutral switch for continuity between the top and bottom terminals. The switch is normal if there is continuity.

Check for shorts between the top terminal and body ground. Replace the switch if there is continuity.

Inspect the neutral switch wire.

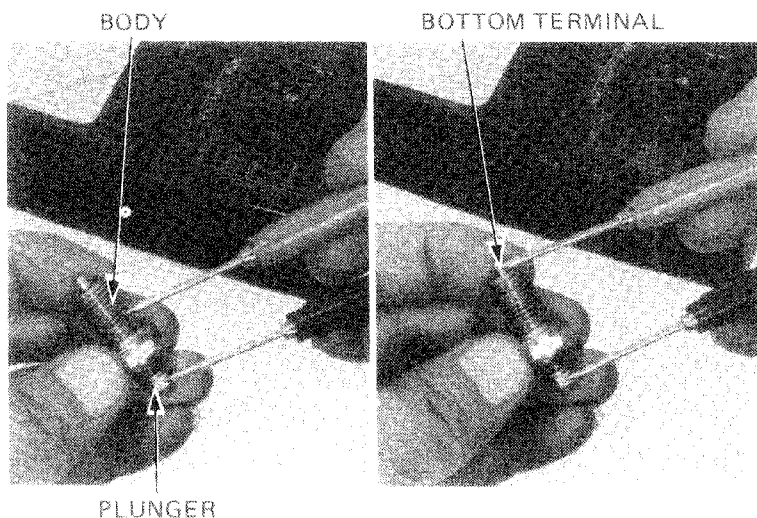



HANDLEBAR SWITCHES

The handlebar cluster switches (lights, turn signals, horn) must be replaced as assemblies.
Continuity tests for the components of the handlebar cluster switches follow:
Continuity should exist between the color coded wires on each chart.

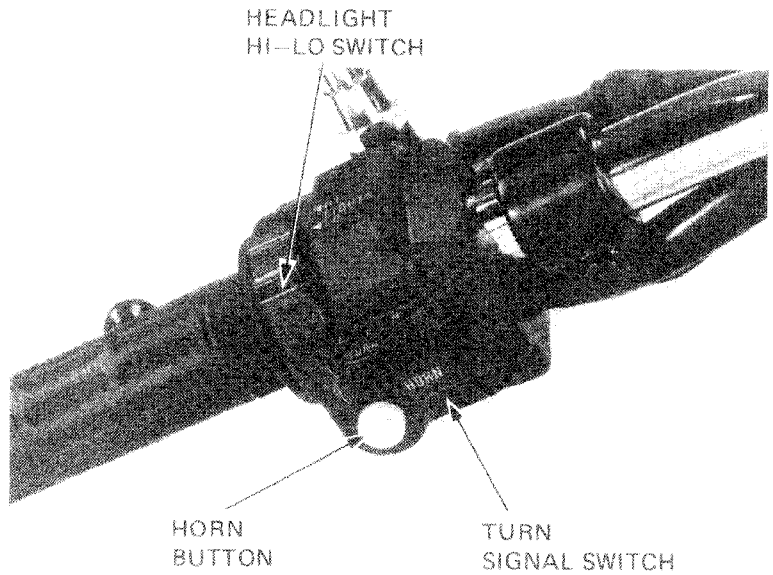

HEADLIGHT HI-LOW SWITCH

HI: L/W or L
MIDDLE (N): L/W to W to L
LO: L/W to W

Headlight Hi-Low Switch

	HL	HI	Lo
Hi	○	○	
(N)	○	○	○
Lo	○		○
Code color	L/W	L	W

TURN SIGNAL SWITCH

LEFT: Gr to O, Br/W to Lb/W
OFF: No continuity
RIGHT: Gr to Lb, Br/W to O/W

Turn Signal Switch

	W	L	R	TLI	PR	PL
LEFT	○	○		○	○	
OFF				○	○	○
RIGHT	○		○	○		○
Code color	Gr	O	Lb	Br/W	Lb/W	O/W

HORN BUTTON

Lg to G with button depressed
No continuity with button released

Horn Button

	Ho	E
Code color	Lg	G

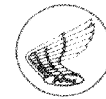

LIGHTS/SWITCHES

STARTER BUTTON

B to Y/R with button depressed

Starter Button

	BAT ₂	ST	BAT ₃	HL
FREE			○ — ○	
START	○ — ○			
Code color	B	Y/R	B/R	L/W

ENGINE STOP SWITCH

RUN: B to B/W
OFF: No continuity

Engine Stop Switch

	BAT ₂	IG ₂
OFF		
RUN	○ — ○	
OFF		
Code color	B	B/W

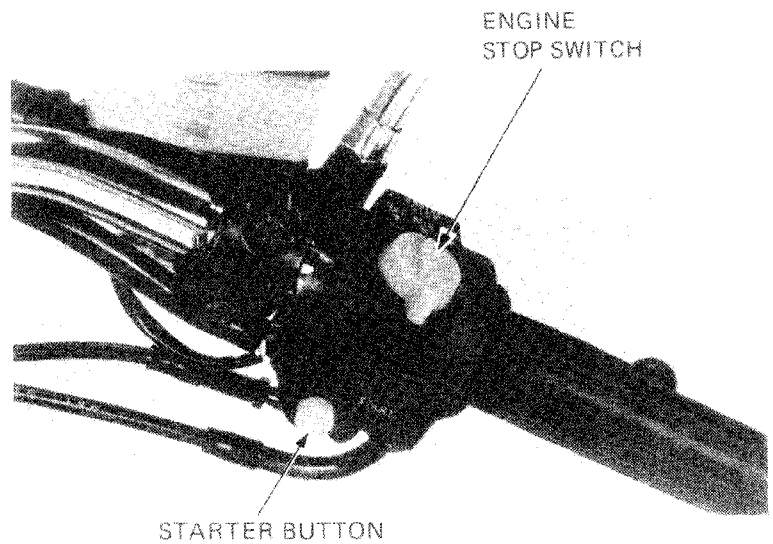

CLUTCH SWITCH

Check continuity of the clutch lever (safety) switch with the clutch released and applied.
Replace if necessary.

CLUTCH APPLIED: CONTINUITY
CLUTCH RELEASES: NO CONTINUITY

REMOVAL

Unplug the wires and remove the clutch lever and cable.

Remove the switch.

NOTE

The switch case has a small protrusion that must point toward the handlebar when installed.

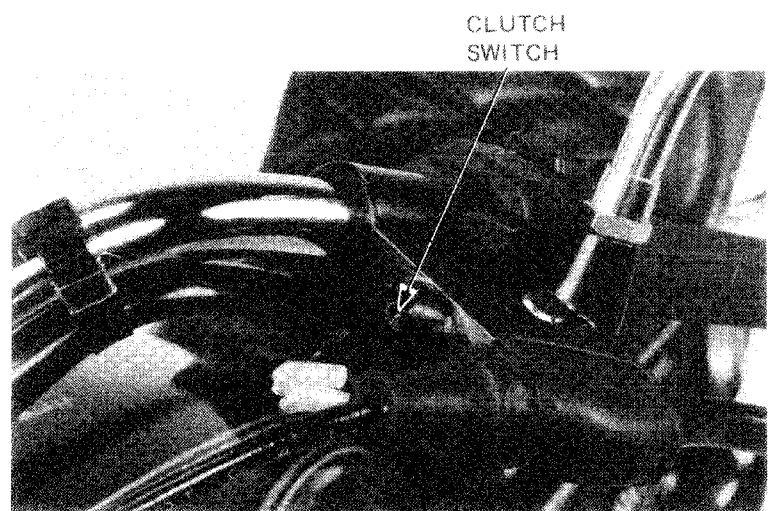



IGNITION SWITCH

Remove the headlight case and instrument cluster. Disconnect the coupler and remove the ignition switch.

NOTE

Identify the wire colors at the connector. There are no colors on the switch.

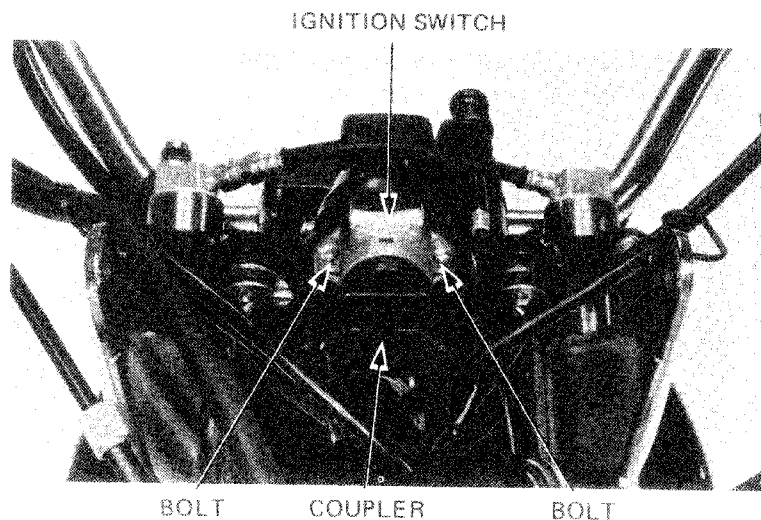

Check continuity of terminals on the ignition switch in each switch position.

SWITCH POSITION

LOCK: No continuity
 OFF: No continuity
 ACC: BAT₁ to ACC
 ON: BAT₁ to IG₁, ACC
 TL₁ to TL₂
 P: BAT₁ to ACC, P

	BAT ₁	IG ₁	ACC	TL ₁	TL ₂	P
LOCK						
OFF						
ACC	○	—	○			
ON	○	○	○	○	○	
P	○	—	○			○

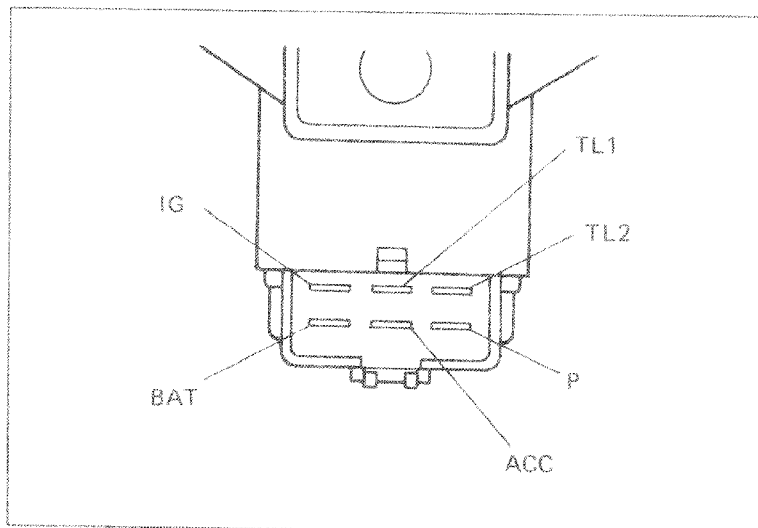



LIGHTS/SWITCHES

IGNITION SWITCH DISASSEMBLY

Insert the key and position it in the middle of "ACC" position.

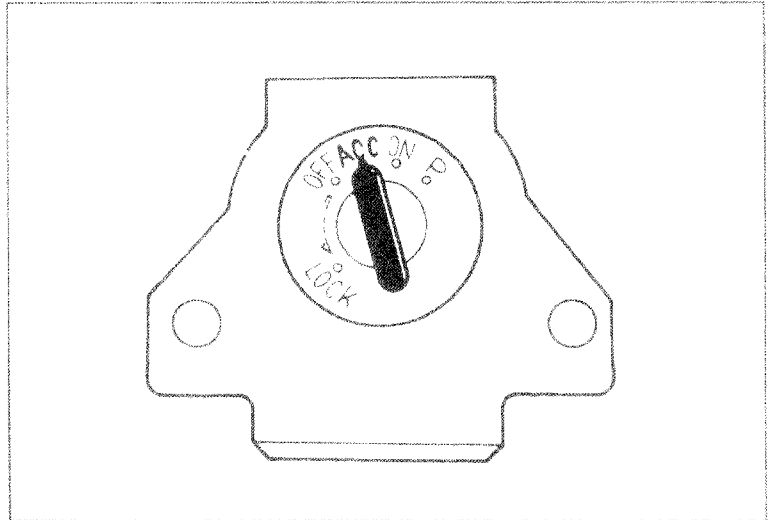

Push the lugs from the slots and remove the contact base.
Assembly is the reverse of removal.

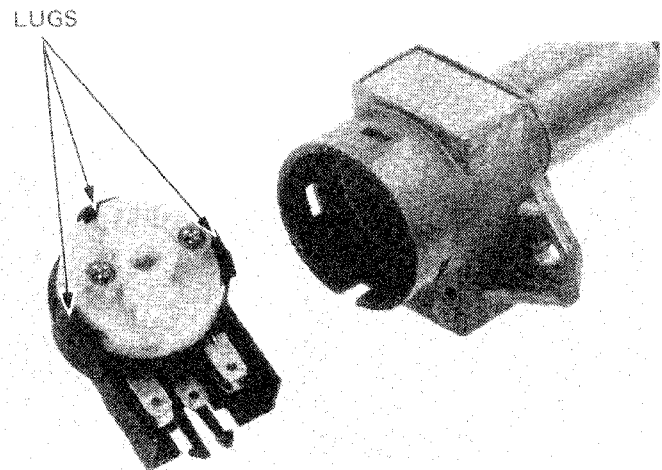
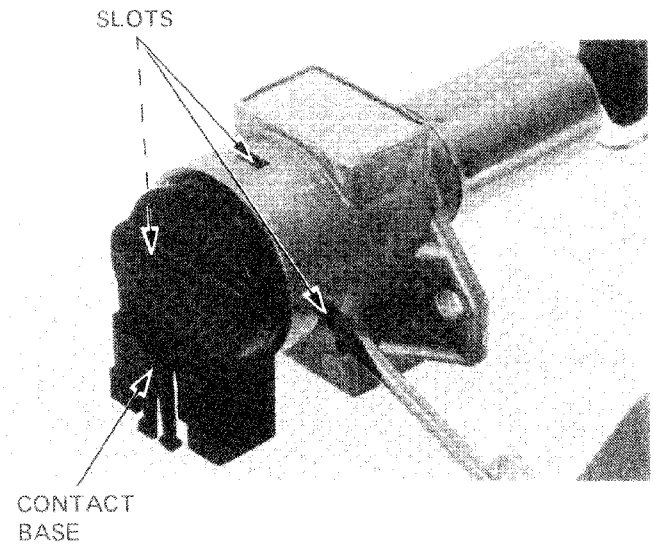



TEMPERATURE GAUGE

Connect a tested sensor and auxiliary voltage regulator as shown to the gauge to be tested.

CAUTION

The temperature gauge operates on 7 volts. Do not apply 12 volts directly to the gauge.

Suspend the sensor in a pan of oil.

Do not let the sensor or thermometer touch the pan or false readings will result.

Compare the gauge readings to the thermometer readings as the oil heats.

NOTE

Refer to page 9-4, for temperature unit inspection.

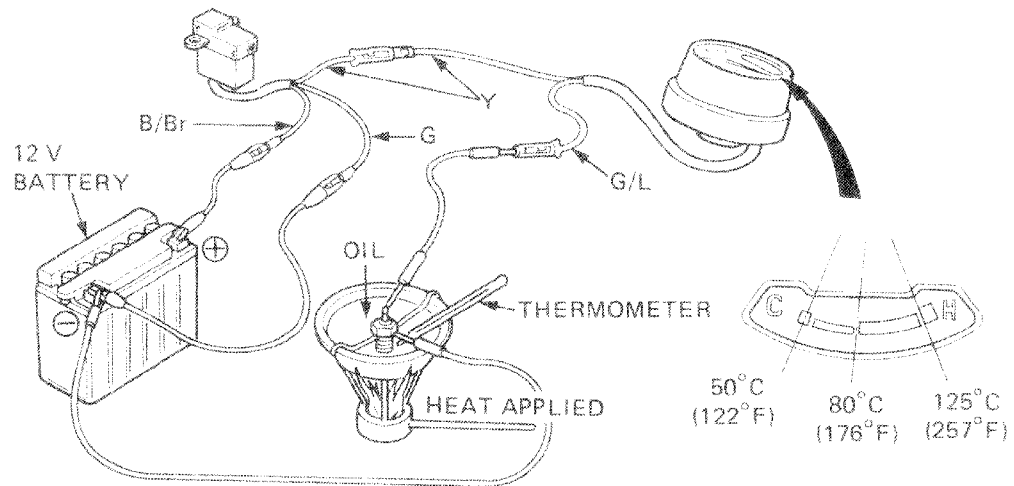

AUXILIARY VOLTAGE REGULATOR INSPECTION

Remove the auxiliary voltage regulator from the rear of the speedometer.

Test the regulator with a battery and voltmeter as shown.

Regulator output voltage should be 7 volts.

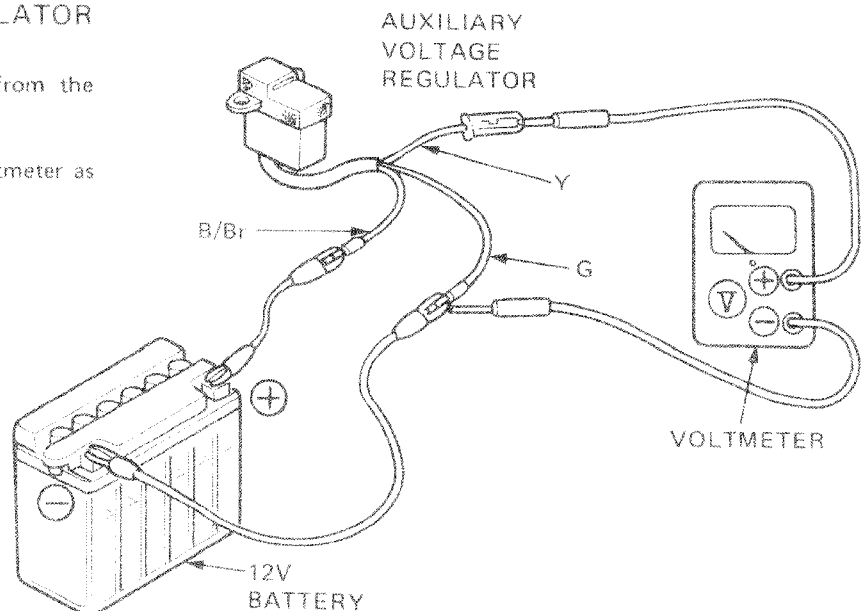



LIGHTS/SWITCHES

BULB REPLACEMENT

INDICATOR BULB

Remove the indicator light panel screws and panel.
Replace the bulb.
If the replacement bulb does not light, check for loose connections, a short or open circuit.

INDICATOR LIGHT PANEL

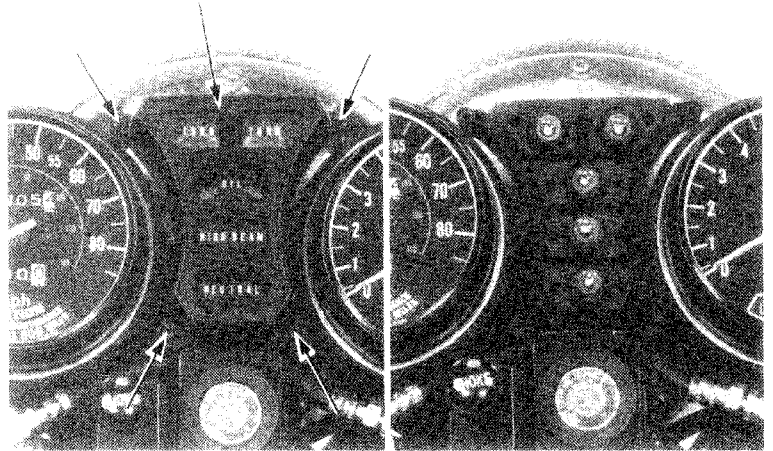

METER ILLUMINATION BULB

Disconnect the meter cable.
Remove the meter mounting nuts and meter.
Remove the bulb socket and replace the bulb.

MOUNTING NUTS

BULB

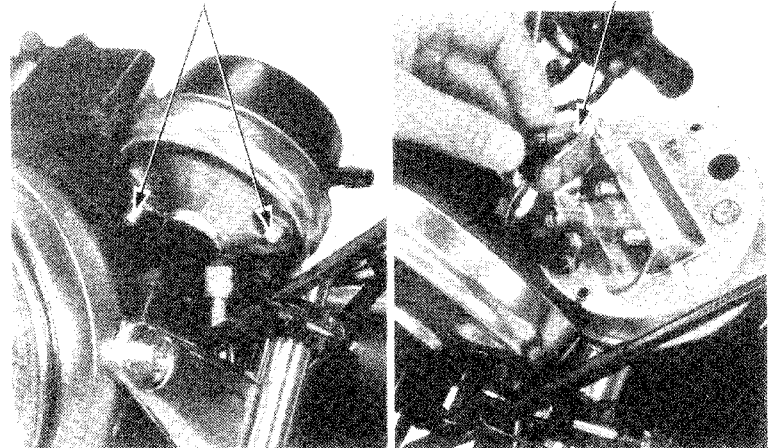

TURN SIGNAL BULB

Remove the turn signal lens to remove the bulb.

CAUTION

Do not overtighten the lens mounting screws to prevent cracking the lens.

LENS MOUNTING SCREWS

BULB

TURN SIGNAL LENS

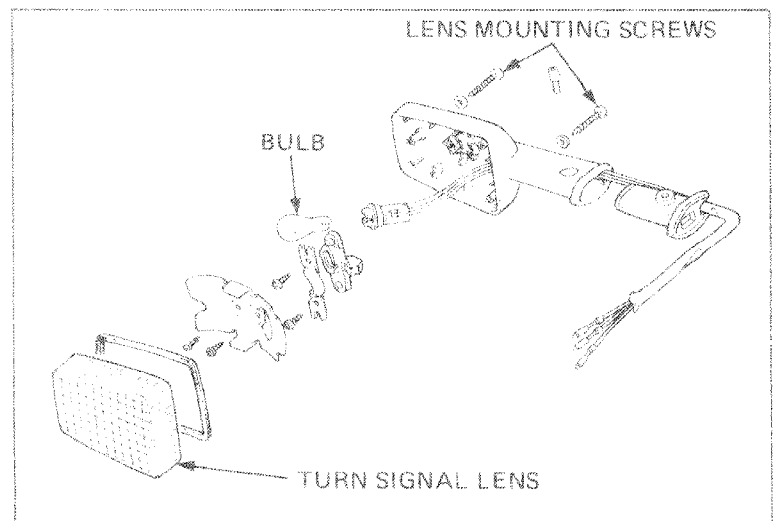



TAILLIGHT

To replace the bulb or any part of the taillight, remove the lens and then remove the part.

CAUTION

Do not overtighten the lens mounting screws to prevent cracking the lens.

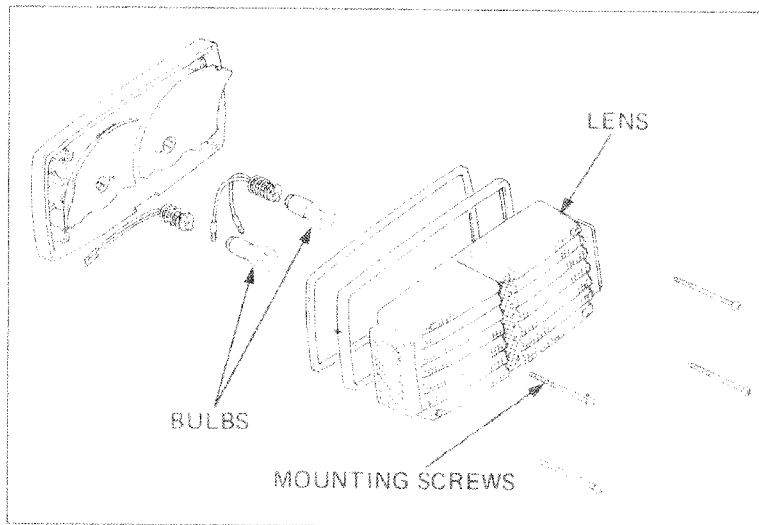

HEADLIGHT

Remove three mounting screws from the headlight case, pull the lamp assembly from the headlight case, and remove the socket from the bulb.

Unfasten the bulb retaining clip and remove the bulb.

Reassemble in the reverse order of disassembly.

CAUTION

Wear clean gloves when installing the halogen bulb. If you touch the bulb with your bare hands, clean it with a cloth moistened with alcohol to prevent its early failure.

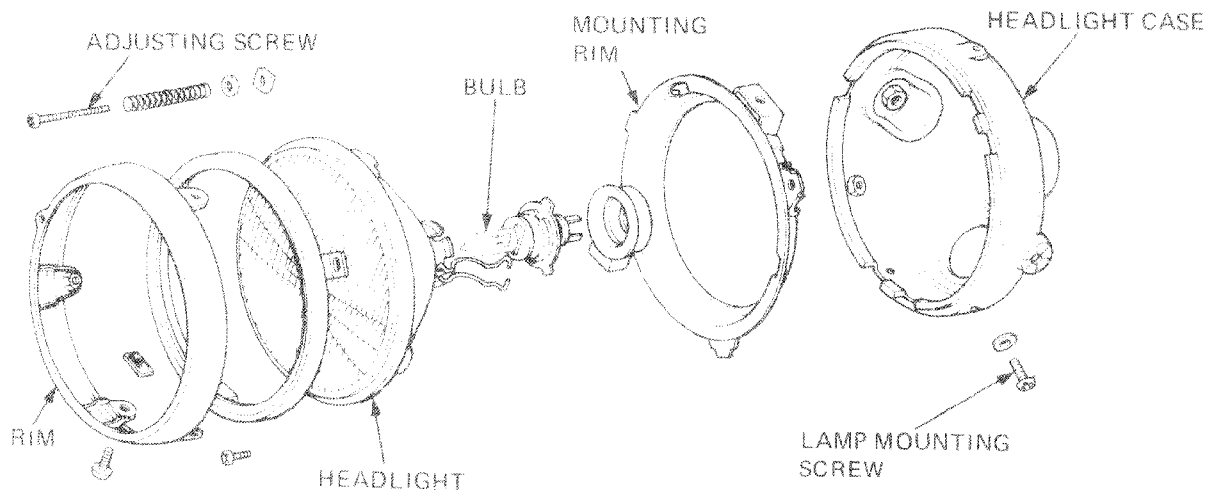
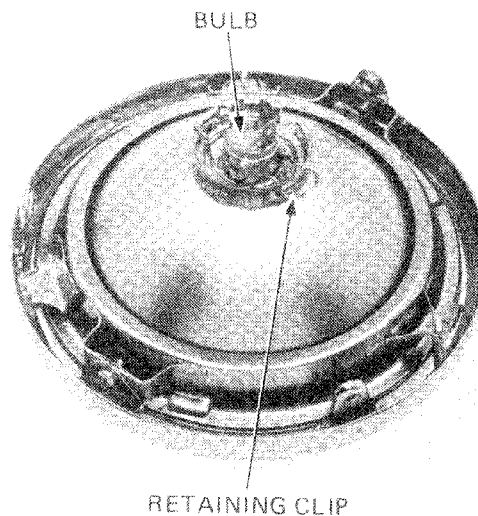



HONDA
GL500
GL500 INTERSTATE

MEMO



SERVICE INFORMATION	20-1
HEADLIGHT	20-2
TURN SIGNAL	20-2
FAIRING AND BRACKET	20-3
ADJUSTMENT	20-5

SERVICE INFORMATION

GENERAL INSTRUCTIONS

- INTERSTATE Cable and harness routing Refer to page 1-6
- INTERSTATE Wiring diagram Refer to page 1-8



INTERSTATE ACCESSORIES

HEADLIGHT

REMOVAL

Loosen the headlight adjusting knob set screw and remove the knob.

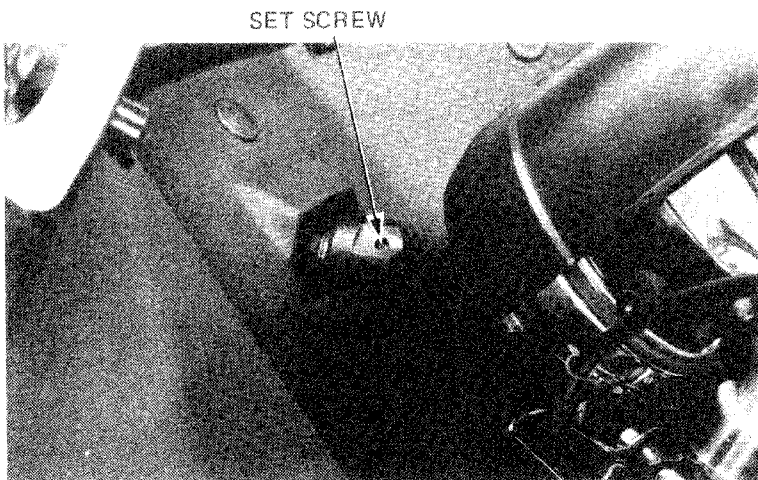

Remove the nut, lockwasher and flat washer and pull off the headlight.

Install in reverse order of removal.

CAUTION

Wear clean gloves when installing the halogen bulb. If you touch the bulb with your bare hands, clean it with a cloth moistened with alcohol to prevent its early failure.

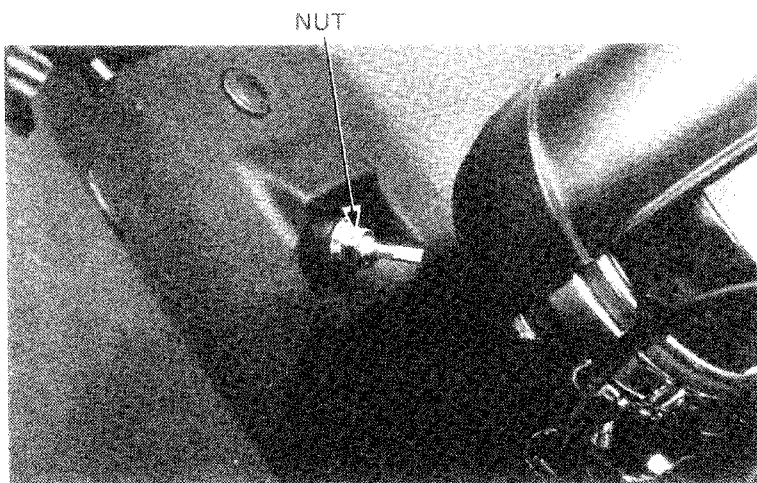

TURN SIGNAL

Remove the turn signal lens to remove the bulb.

CAUTION

Do not overtighten the lens mounting screws to prevent cracking the lens.

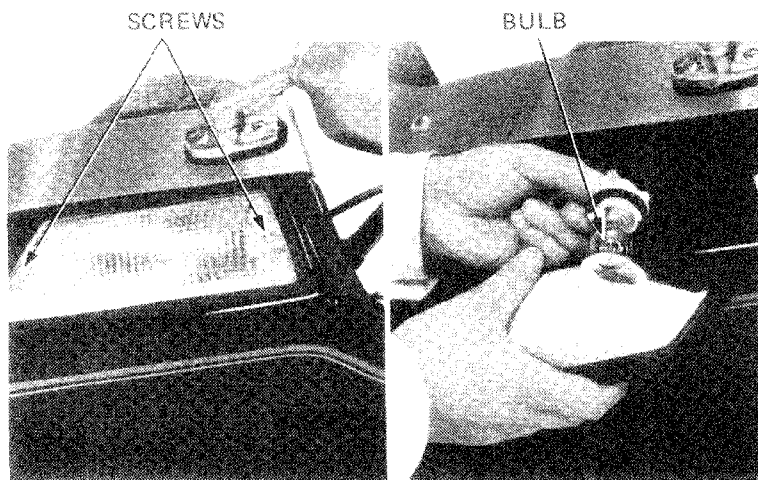



FAIRING AND BRACKET

REMOVAL

Disconnect the fairing wire harness from the main harness at the 9-pin connector on the left side of the fairing.

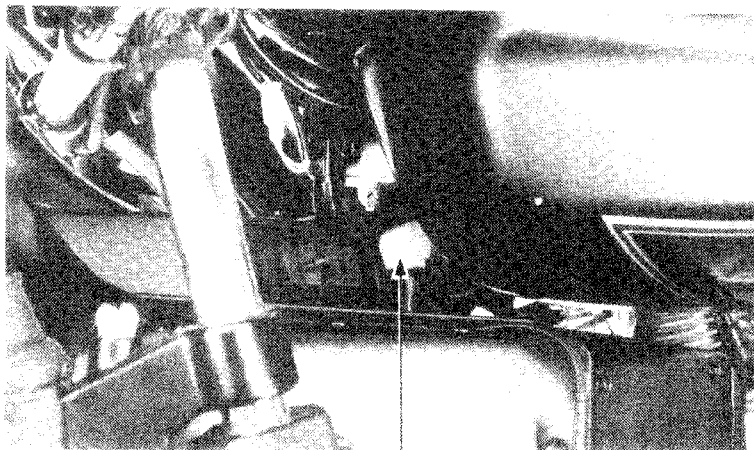

COUPLER

Remove the three screws and collars (each side) and remove the right and left lower fairing panels.

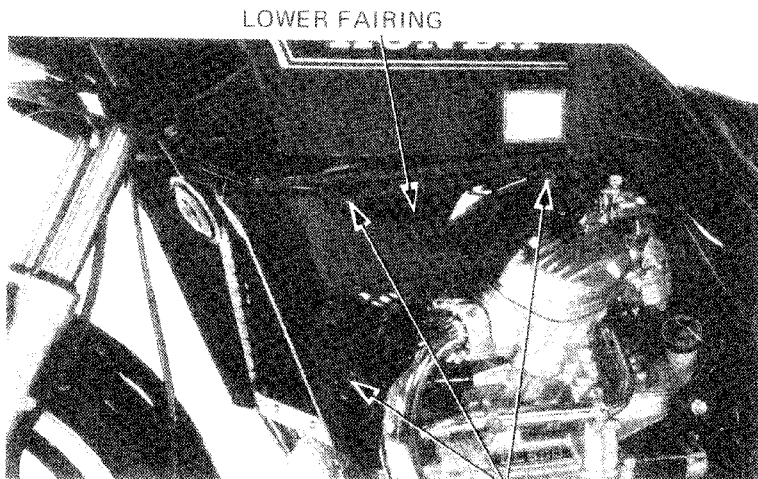

LOWER FAIRING

SCREWS

Remove the four cap nuts, flat washers and lock washers.

Remove the four flange nuts from the fairing studs.

Remove the fairing.

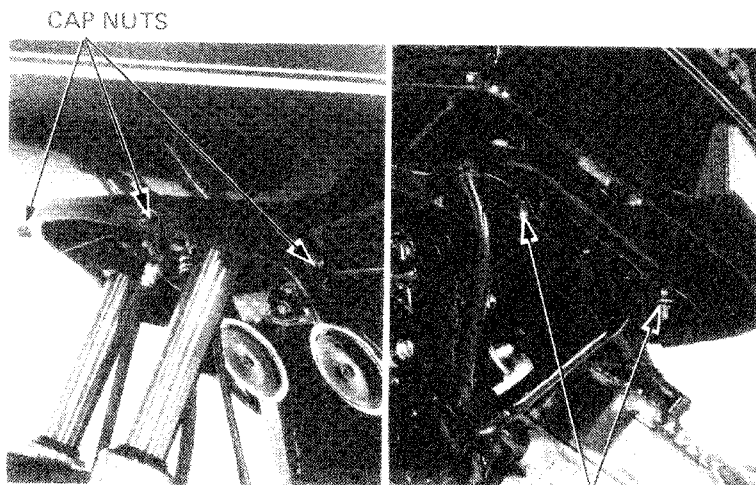

CAP NUTS

FLANGE NUTS



INTERSTATE ACCESSORIES

Disconnect the horn wires, remove the retaining bolts and remove the horns from the bracket.

Remove the front cowl brackets.
Remove the 10 mm nuts and 8 mm bolt, then carefully work the bracket out of the frame.
Install in the reverse order of removal.

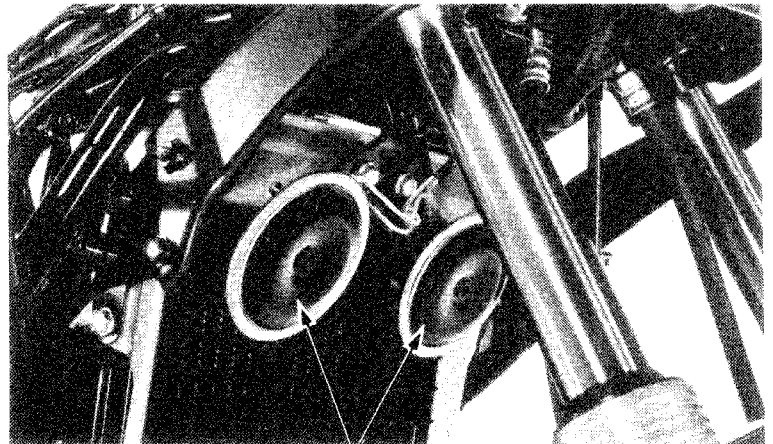

HORNS

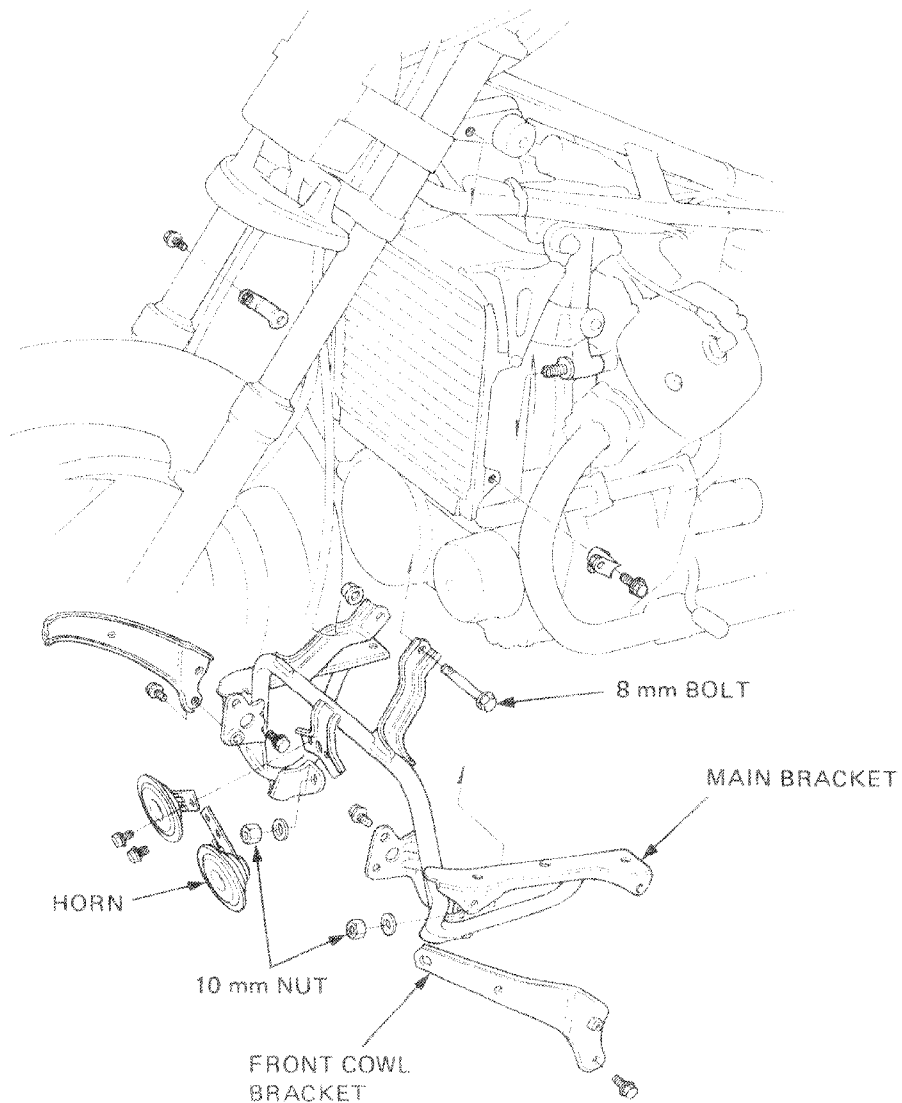



ADJUSTMENT

WINDSHIELD

The windshield height can be adjusted one inch in either direction from the standard position.

To adjust height, loosen the rearview mirror and trim screws in the order shown.

After adjusting tighten the screws in the reverse order.

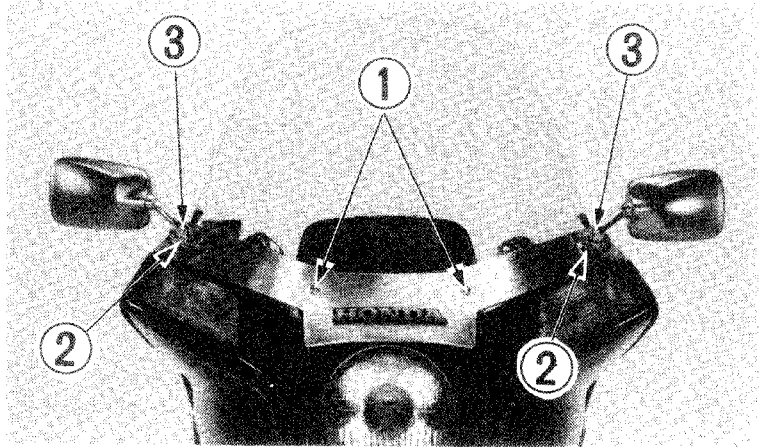

HEADLIGHT

Vertical adjustments can be made with the beam adjusting knob. Horizontal adjustments are made by turning the adjustment screw located on the right side of the headlight.

WARNING

An improperly adjusted headlight may blind oncoming drivers, or it may fail to light the road for a safe distance.

NOTE

Adjust the headlight beam as specified by local laws and regulations.

BEAM ADJUSTING KNOB

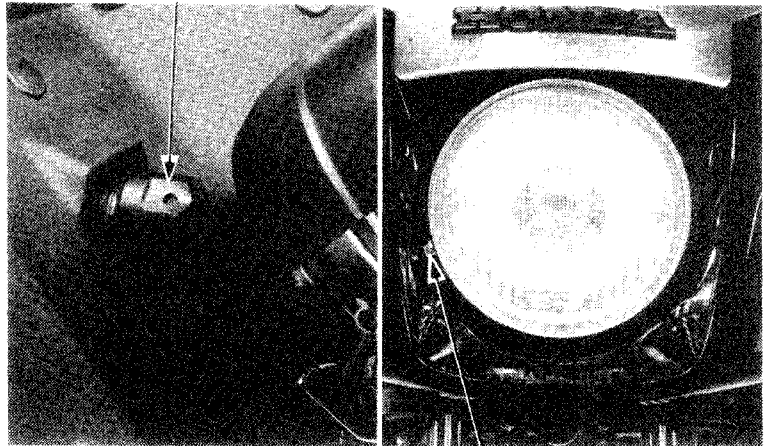

ADJUSTING
SCREW



HONDA
GL500
GL500 INTERSTATE

MEMO



PRO-LINK REAR SUSPENSION

INTRODUCTION

The Pro-Link suspension system is a single shock absorber connected to the swingarm and the lower frame with a shock arm and shock link. The shock absorber and linkage are located in front of the rear tire.

The carefully designed pivoting shock arm and shock link, combined with the shock's matched spring and damping rates, provide what is known as a "progressively rising rate" suspension. This provides relatively soft springing and damping during initial wheel travel and increasing spring and damping rates to meet increasing wheel travel with greater resistance.

This "progressively rising rate" enables the rear wheel to transfer more power to the ground, giving the rider greater comfort as well as the best possible control over rough terrain.

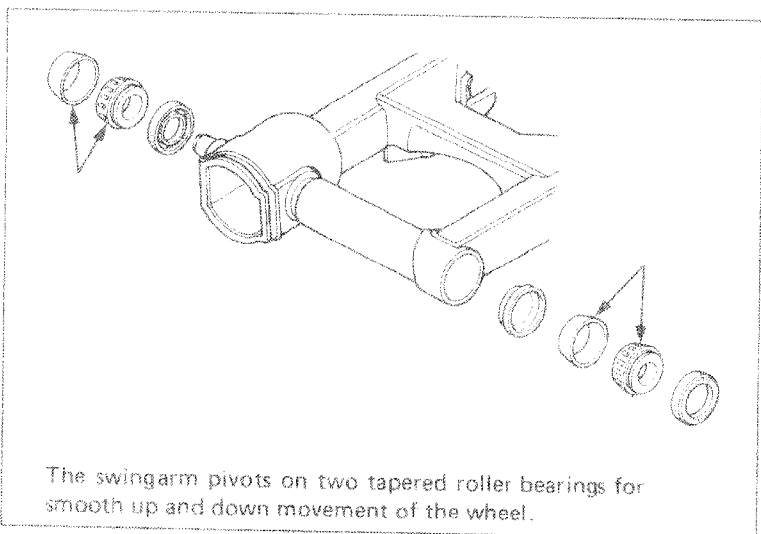
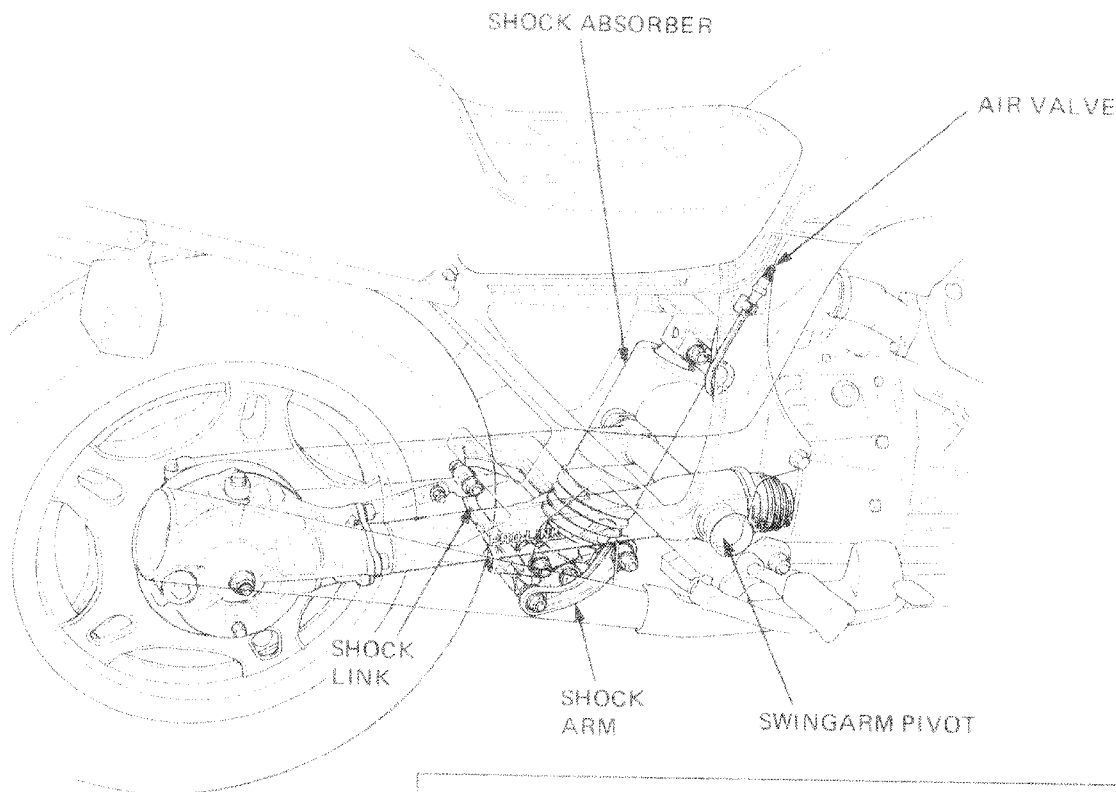



TECHNICAL FEATURES

OPERATION

As the wheel and swingarm are driven up by bumps, the shock absorber is compressed by the shock arm which is held in a precise arc by the shock link. As wheel travel increases the shock arm rises above the swingarm proportionately increasing absorber compression (more shock rod travel per unit of rear wheel travel).

This provides the progressive rise rate; the shock absorber moves only about one-fourth of wheel travel at the beginning and moves about one-third of wheel travel near the end.

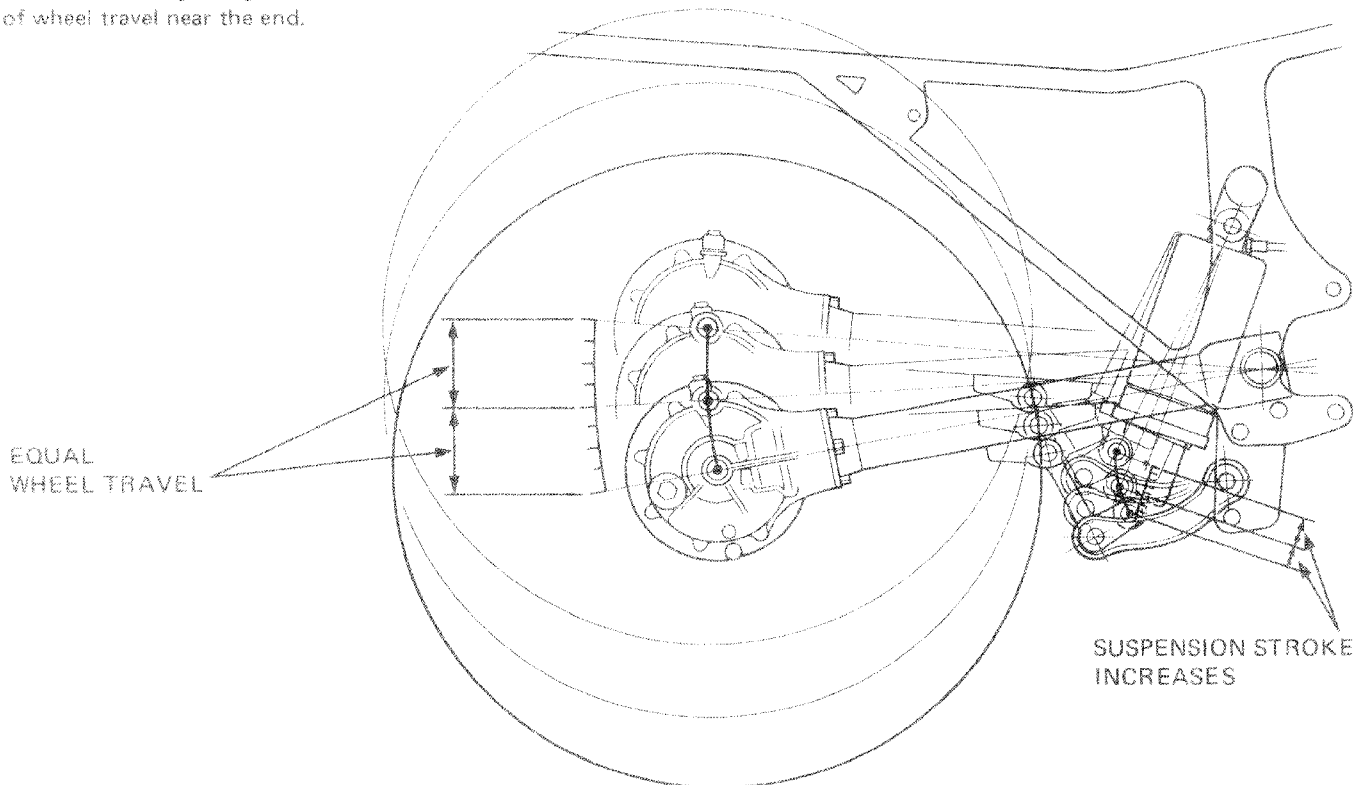

This graph shows the wheel travel/shock travel ratio through the entire stroke of a GL500 Pro-Link system.

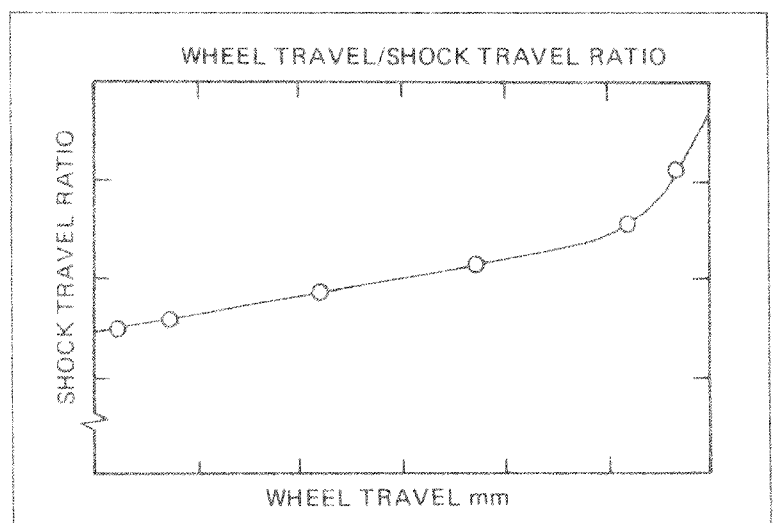



22. TROUBLESHOOTING

ENGINE DOES NOT START OR IS HARD TO START

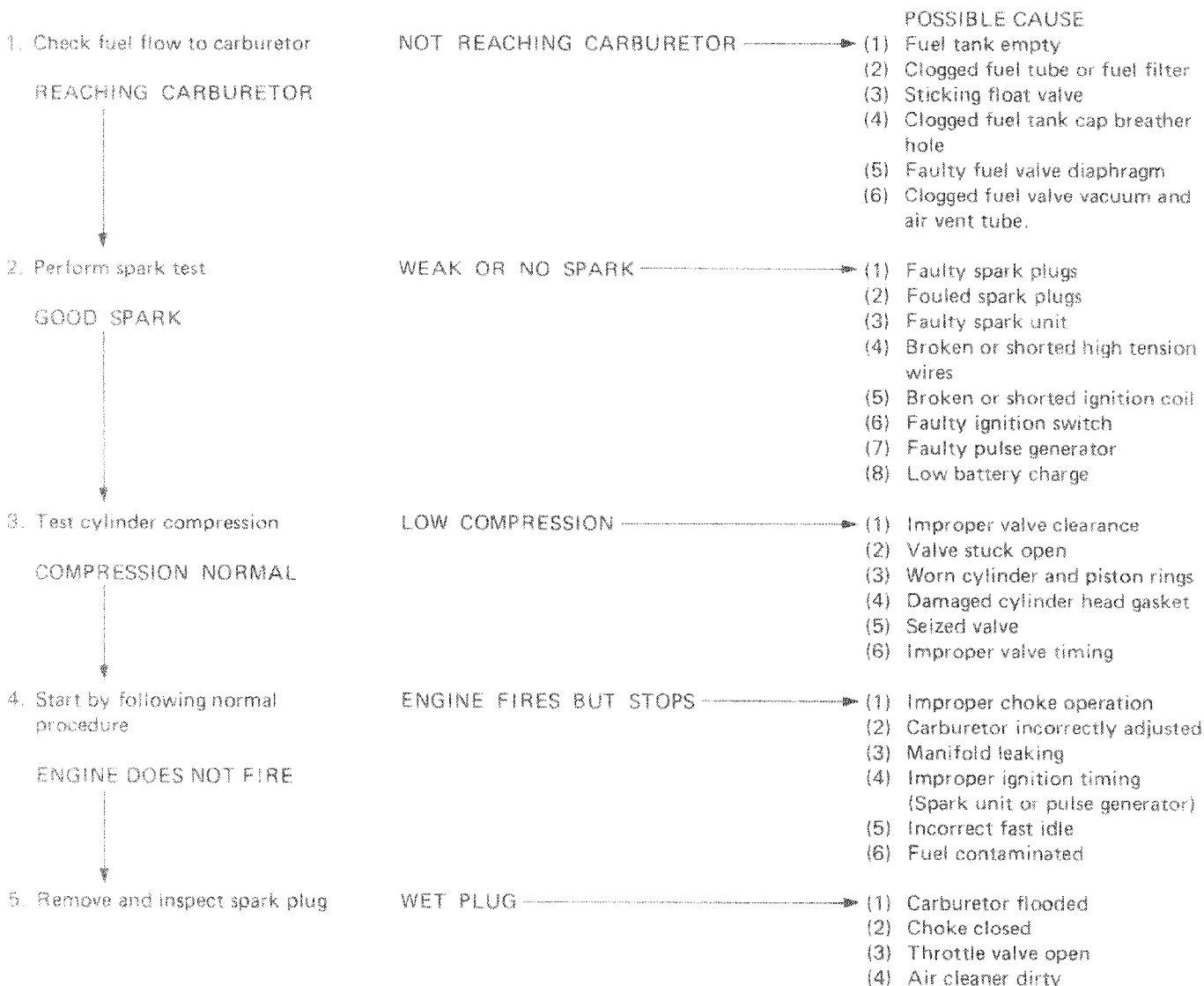



TROUBLESHOOTING

ENGINE LACKS POWER

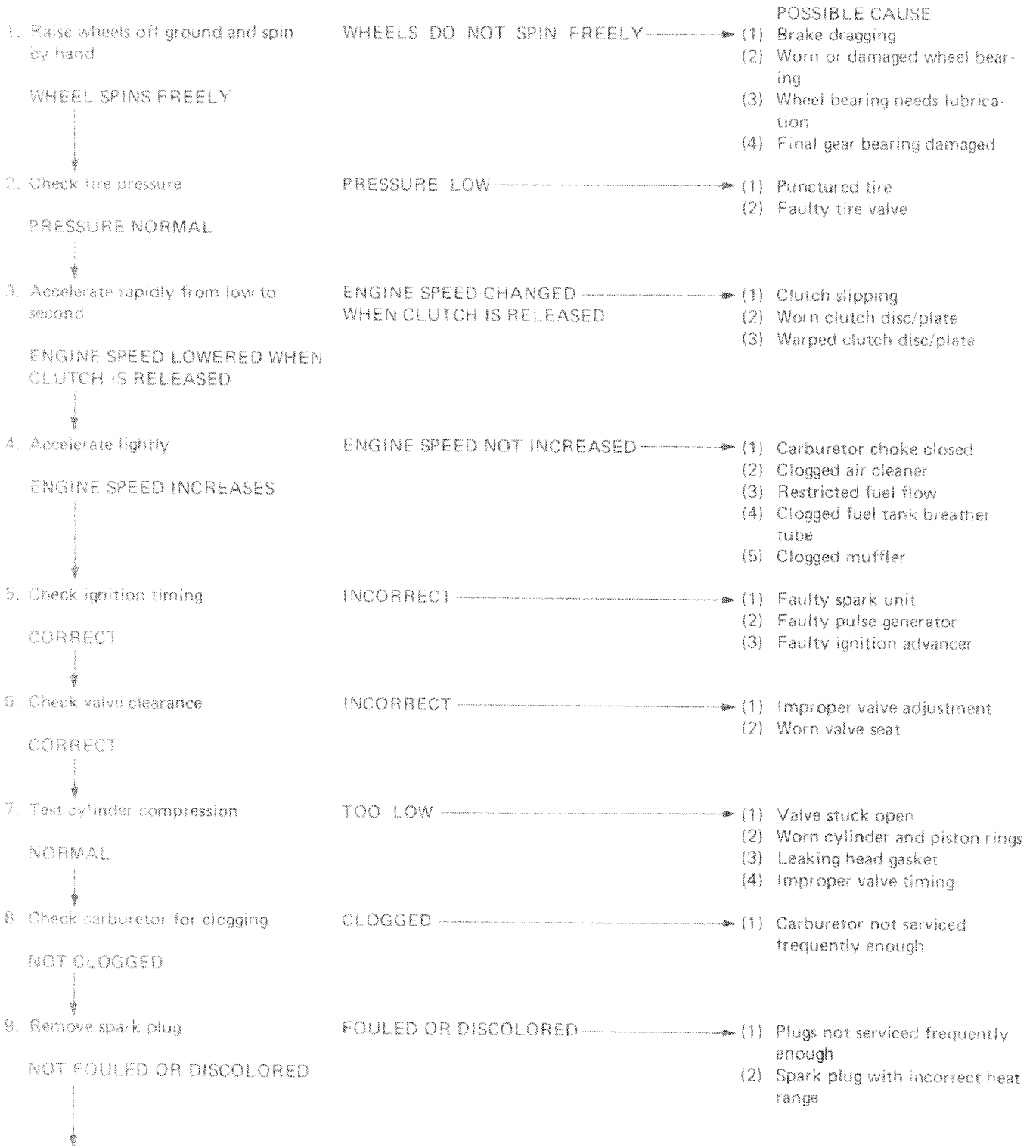



<p>10. Check oil level and condition</p> <p style="text-align: center;">CORRECT ↓</p>	<p>INCORRECT →</p>	<p>(1) Oil level too high (2) Oil level too low (3) Contaminated oil</p>
<p>11. Remove cylinder head cover and inspect lubrication</p> <p style="text-align: center;">VALVE TRAIN LUBRICATED PROPERLY ↓</p>	<p>VALVE TRAIN NOT LUBRICATED PROPERLY →</p>	<p>(1) Clogged oil passage (2) Clogged oil control orifice</p>
<p>12. Check for engine overheating</p> <p style="text-align: center;">NOT OVERHEATING ↓</p>	<p>OVERHEATING →</p>	<p>(1) Excessive carbon build-up in combustion chamber (2) Use of poor quality fuel (3) Clutch slipping</p>
<p>13. Accelerate or run at high speed</p> <p style="text-align: center;">ENGINE DOES NOT KNOCK ↓</p>	<p>ENGINE KNOCKS →</p>	<p>(1) Worn piston and cylinder (2) Wrong type of fuel (3) Excessive carbon build-up in combustion chamber (4) Ignition timing too advanced (Faulty spark unit or advancer)</p>

POOR PERFORMANCE AT LOW AND IDLE SPEEDS

<p>1. Check ignition timing and valve clearance</p> <p style="text-align: center;">CORRECT ↓</p>	<p>INCORRECT →</p>	<p>POSSIBLE CAUSE (1) Improper valve clearance (2) Improper ignition timing (Faulty spark unit or spark advancer)</p>
<p>2. Check carburetor pilot screw adjustment</p> <p style="text-align: center;">CORRECT ↓</p>	<p>INCORRECT →</p>	<p>See Fuel System Section</p>
<p>3. Check for leaking manifold</p> <p style="text-align: center;">NO LEAK ↓</p>	<p>LEAKING →</p>	<p>(1) Deteriorated insulator O-ring (2) Loose carburetor (3) Damaged fuel valve vacuum tube</p>
<p>4. Perform spark test</p> <p style="text-align: center;">GOOD SPARK ↓</p>	<p>WEAK OR INTERMITTENT SPARK →</p>	<p>(1) Faulty, carbon or wet fouled spark plug (2) Faulty spark unit (3) Faulty ignition coil (4) Faulty spark advancer</p>



TROUBLESHOOTING

POOR PERFORMANCE AT HIGH SPEED

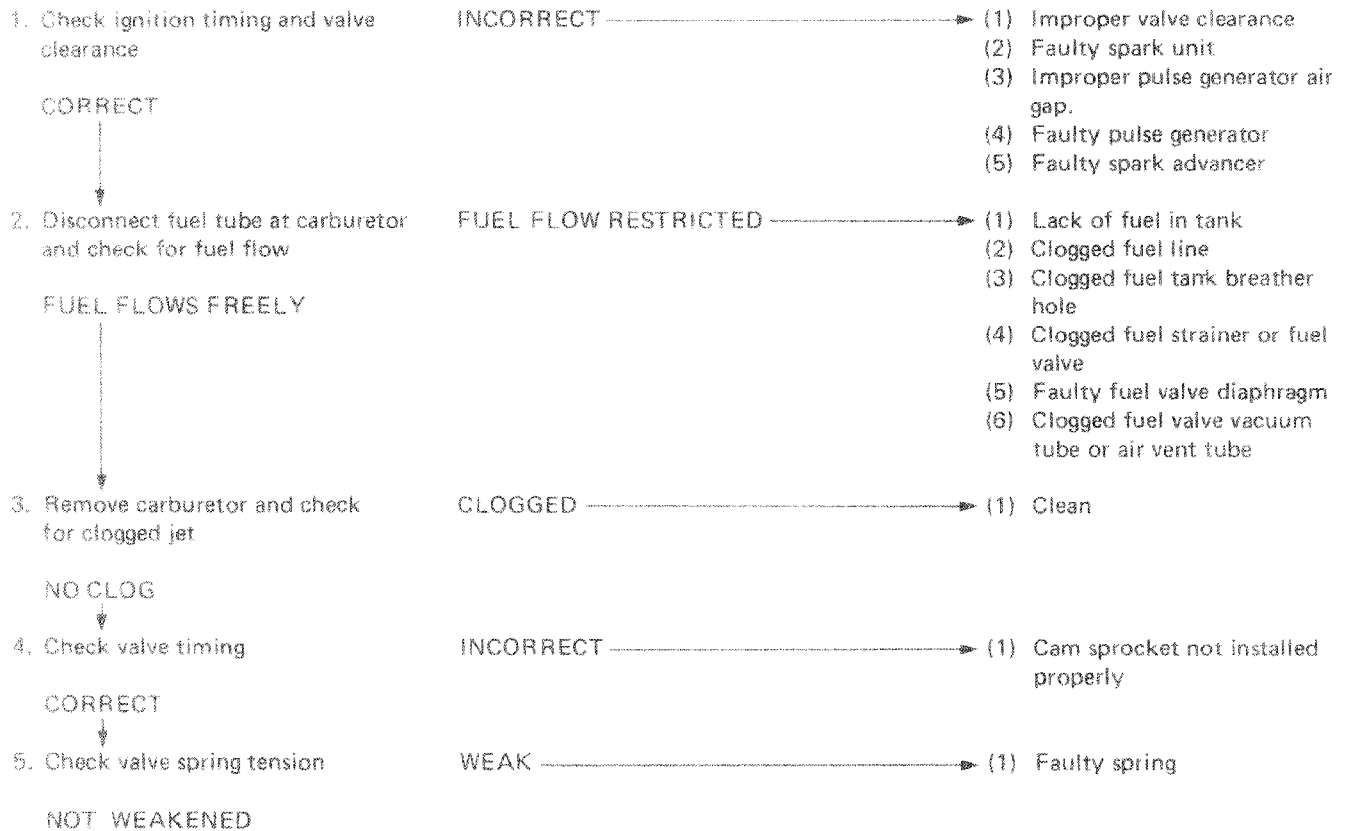

POOR HANDLING ----- Check tire pressure

- | | |
|----------------------------------------------------------------|-------------------------------------------------------------------------------------------------------------------------------------------------------------------------------------------------------------------------------|
| <p>1. If steering is heavy</p> <p>-----></p> | <p>(1) Steering top thread nut too tight
(2) Damaged steering head bearings</p> |
| <p>2. If either wheel is wobbling</p> <p>-----></p> | <p>(1) Excessive wheel bearing play
(2) Distorted rim
(3) Improperly installed wheel hub
(4) Swing arm pivot bearing excessively worn
(5) Distorted frame
(6) Swingarm pivot adjusting bolt too tight</p> |
| <p>3. If the motorcycle pulls to one side</p> <p>-----></p> | <p>(1) Bent frame
(2) Front and rear wheels not aligned
(3) Bent front fork tube or fork bridge
(4) Bent swingarm</p> |

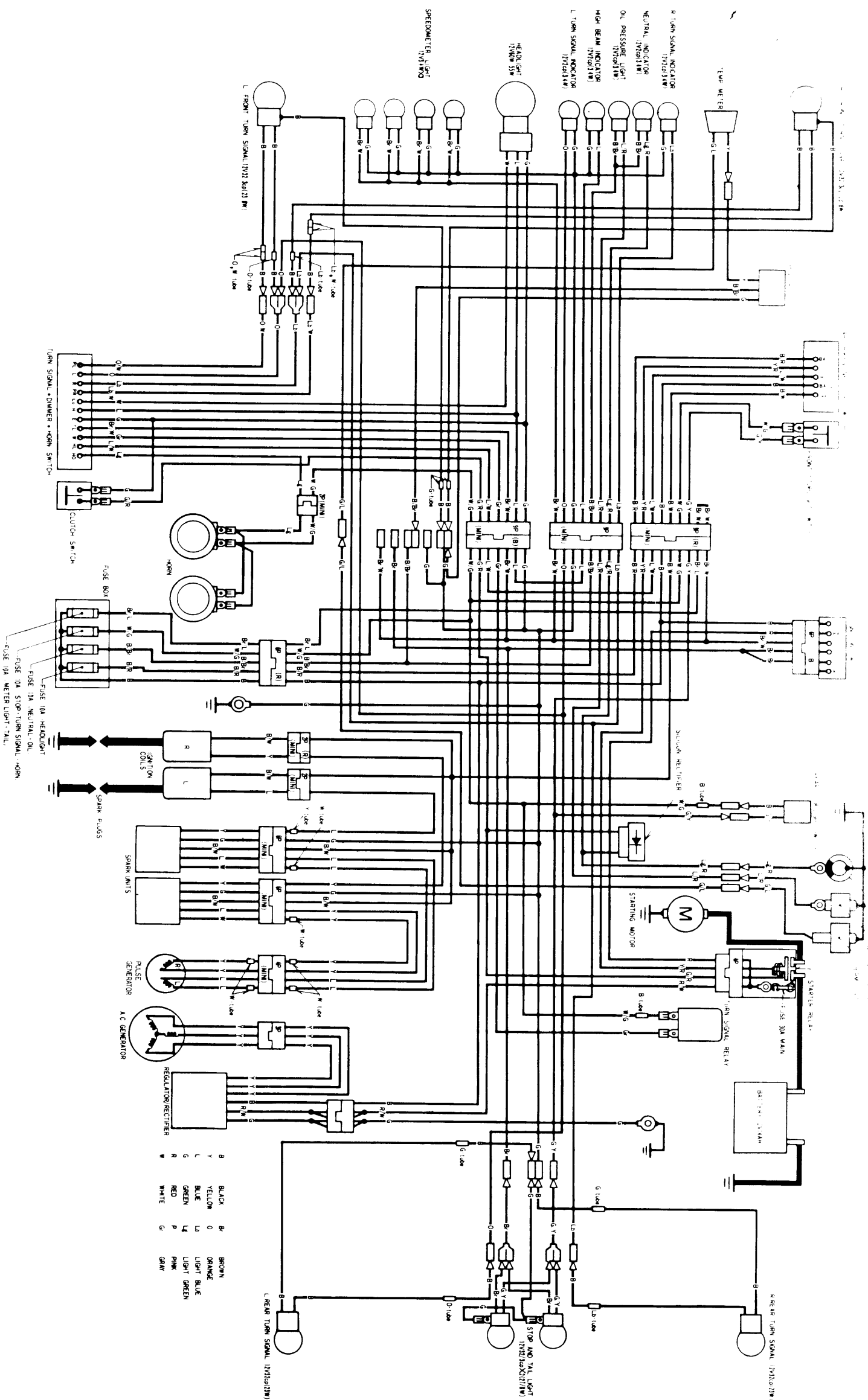

- B BLACK
- Y YELLOW
- G GREEN
- R RED
- W WHITE
- G/L GREEN/BLACK
- B/L BLUE/BLACK
- Y/L YELLOW/BLACK
- R/L RED/BLACK
- W/L WHITE/BLACK
- B/B BROWN
- O ORANGE
- L LIGHT BLUE
- L/L LIGHT GREEN
- P PINK
- G/P GRAY

0030Z-MA1-6700

IGNITION SWITCH

BATT	IG	ACC	T/L	T/L2	P
LOOK					
DEF					
ON					

ENGINE STOP SWITCH

BA7Z	IGZ	BA73	HL	BA7Z	S*
FREE					
PUSH					

TURN SIGNAL SWITCH

R	L	TL	PL	HL	H	L

GL500 INTERSTATE

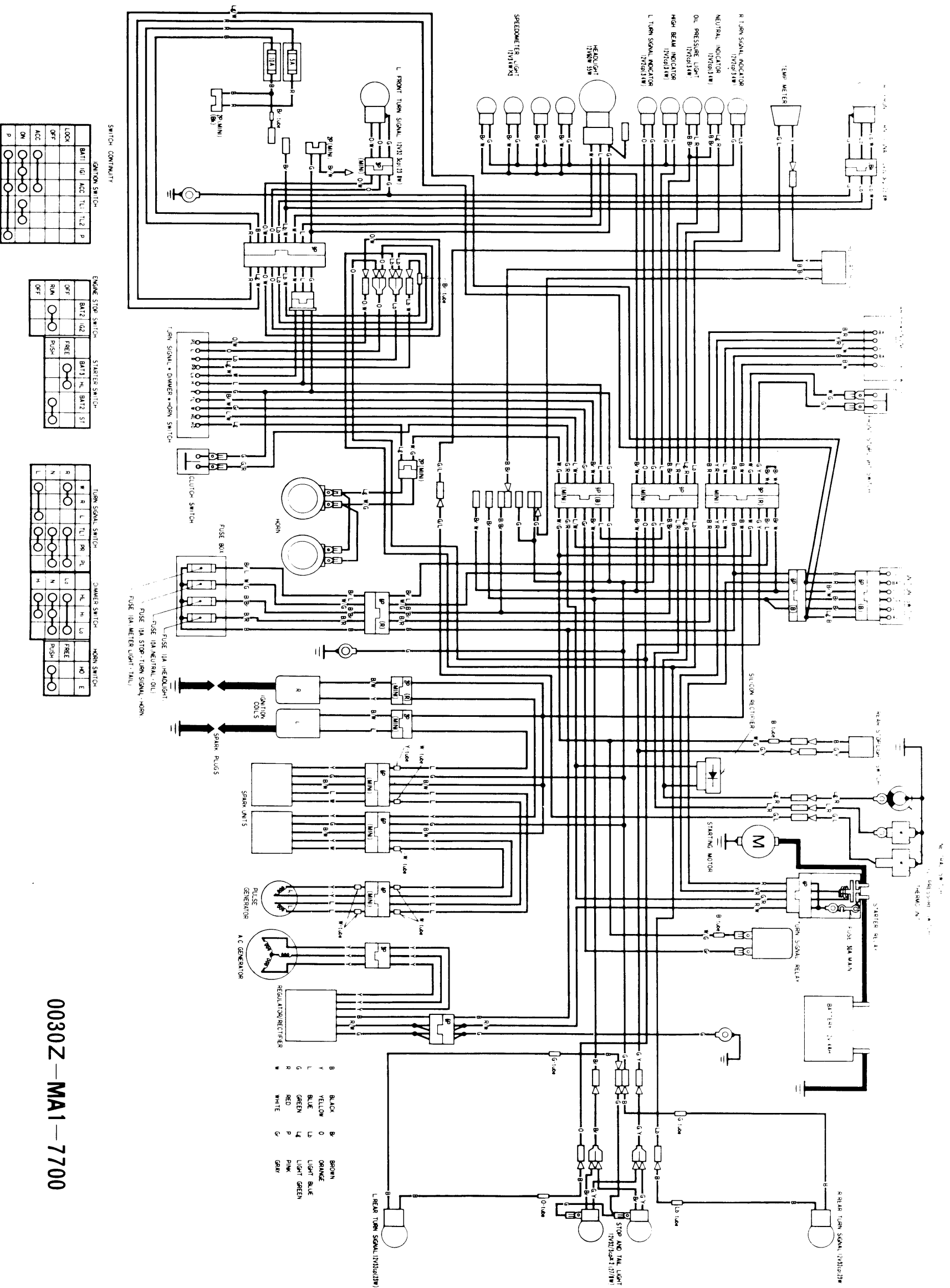

0030Z-MA1-7700



INTRODUCTION

This Addendum contains information for the 1982 GL500/GL500 Interstate. Refer to the base shop manual for service procedures and data not included.

ALL INFORMATION, ILLUSTRATIONS, DIRECTIONS AND SPECIFICATIONS INCLUDED IN THIS PUBLICATION ARE BASED ON THE LATEST PRODUCT INFORMATION AVAILABLE AT THE TIME OF APPROVAL FOR PRINTING. HONDA MOTOR CO., LTD. RESERVES THE RIGHT TO MAKE CHANGES AT ANY TIME WITHOUT NOTICE AND WITHOUT INCURRING ANY OBLIGATION WHATEVER. NO PART OF THIS PUBLICATION MAY BE REPRODUCED WITHOUT WRITTEN PERMISSION.

HONDA MOTOR CO., LTD.
Service Publications Office

CONTENTS

1. MODEL IDENTIFICATION	23-2
2. GENERAL INFORMATION	23-3
Specifications	
Cable & Harness Routing	
3. MAINTENANCE	23-4
Maintenance Schedule	
Oil Recommendation	
Spark Plugs	
Fuel Strainer	
4. WIRING DIAGRAMS	23-7



I. MODEL IDENTIFICATION

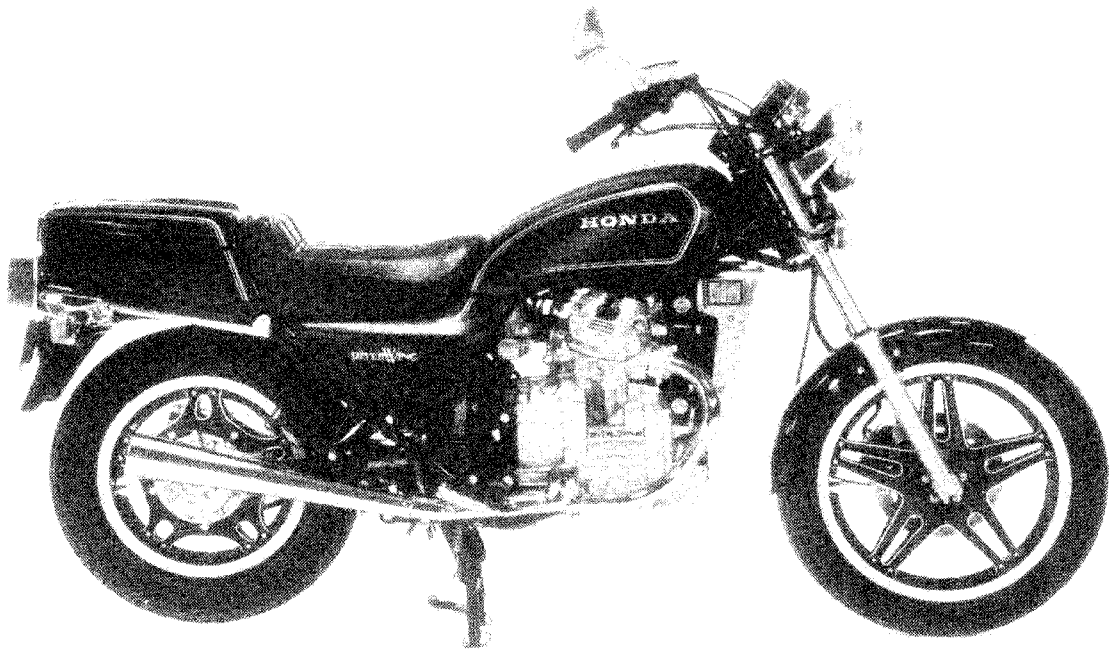

GL500 BEGINNING WITH F/N PC020 * CM100001~

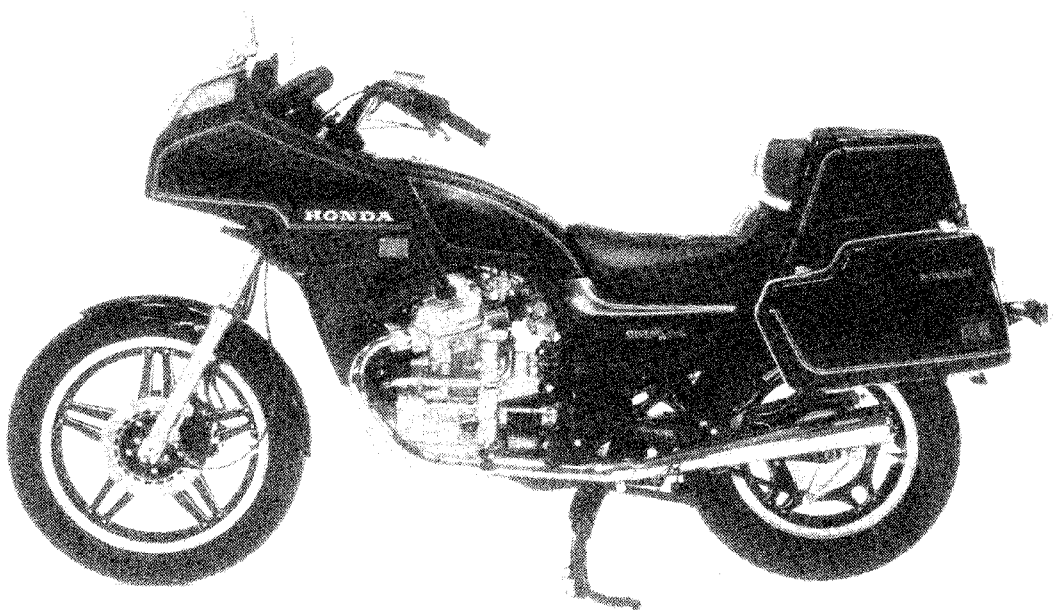

GL500 INTERSTATE BEGINNING WITH F/N PC021 * CM100001~



II. GENERAL INFORMATION SPECIFICATIONS

The specifications listed are new for 1982. Refer to the base manual for specifications not listed here.

ITEM		GL500	GL500 INTERSTATE
DIMENSIONS	Overall width	875 mm (34.4 in)	875 mm (34.4 in)
	Overall height	1,178 mm (46.4 in)	1,504 mm (59.2 in)
	Ground clearance	152 mm (6.0 in)	148 mm (5.8 in)
ENGINE	Engine weight	65 kg (143 lb)	
ELECTRICAL	Spark plug Standard	DR8ES-L (NGK) or X24ESR-U (ND)	
	For extended high speed riding	DR8ES (NGK) or X27ESR-U (ND)	
	Fuse	5 A, 10 A, 30 A (Main fuse)	1 A, 2 A, 5 A, 10 A, 30 A (Main fuse)

CABLE & HARNESS ROUTING

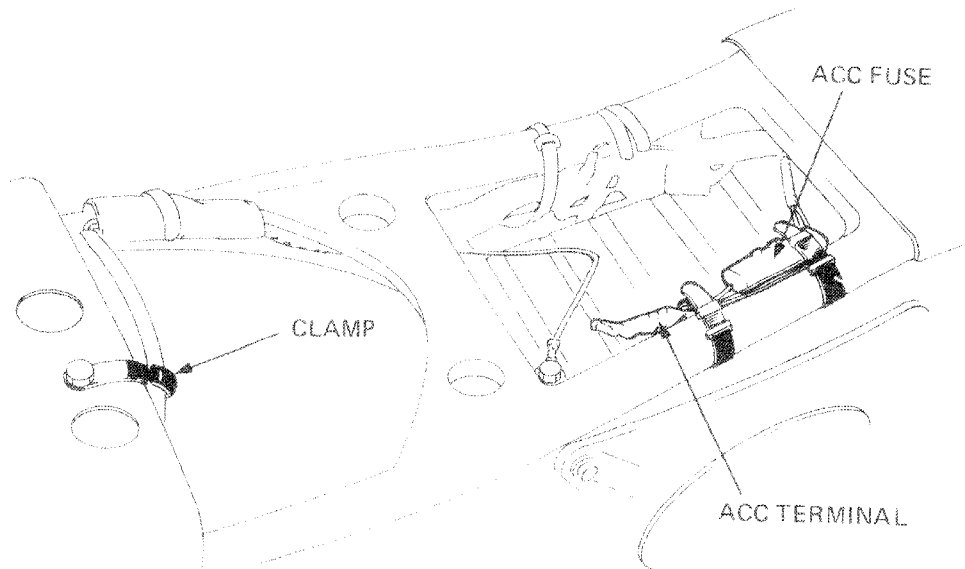



III. MAINTENANCE MAINTENANCE SCHEDULE

Perform the PRE-RIDE INSPECTION in the Owner's Manual at each scheduled maintenance.

- I: INSPECT AND CLEAN, ADJUST, LUBRICATE OR REPLACE IF NECESSARY
- C: CLEAN
- R: REPLACE
- A: ADJUST
- L: LUBRICATE

ITEM	FREQUENCY	WHICHEVER COMES FIRST ↓	ODOMETER READING [NOTE 3]							REFER TO PAGE
			EVERY	600 mi. (1,000 km)	4,000 mi. (6,400 km)	8,000 mi. (12,800 km)	12,000 mi. (19,200 km)	16,000 mi. (25,600 km)	20,000 mi. (32,000 km)	
* FUEL LINES					I		I		I	3- 4
* FUEL STRAINER			C	C	C	C	C	C	C	23- 6
* THROTTLE OPERATION			I		I		I		I	3- 4
* CARBURETOR-CHOKE					I		I		I	3- 5
AIR CLEANER	NOTE 1			C	R	C	R	C	R	3- 5
CRANKCASE BREATHER	NOTE 2			C	C	C	C	C	C	3- 6
SPARK PLUGS				R	R	R	R	R	R	23- 7
* VALVE CLEARANCE			I	I	I		I		I	3- 7
ENGINE OIL	YEAR		R		R		R		R	2- 2
ENGINE OIL FILTER	YEAR		R		R		R		R	2- 2
* CAM CHAIN TENSION			A	A	A	A	A	A	A	3- 9
* CARBURETOR SYNCHRONIZE			I		I		I		I	3- 9
* CARBURETOR IDLE SPEED			I	I	I	I	I	I	I	3-10
RADIATOR COOLANT					I		I		*R	3-10
* RADIATOR CORE					I		I		I	3-10
* COOLING SYSTEM, HOSES			I		I		I		I	3-11
* DRIVE SHAFT JOINT					L		L		L	2- 3
FINAL DRIVE OIL					I		I		R	2- 3
BATTERY	MONTH		I	I	I	I	I	I	I	3-11
BRAKE FLUID (FRONT)	MONTH 2 YEARS *R		I	I	I	I	I	I	*R	3-11
BRAKE SHOE/PAD WEAR				I	I	I	I	I	I	3-12
BRAKE SYSTEM (REAR)			I		I		I		I	3-12
* BRAKE LIGHT SWITCH			I		I		I		I	3-13
* HEADLIGHT AIM			I		I		I		I	3-13
CLUTCH			I	I	I	I	I	I	I	3-14
SIDE STAND					I		I		I	3-14
* SUSPENSION			I		I		I		I	3-15
* NUTS, BOLTS, FASTENERS			I		I		I		I	3-16
** WHEELS			I		I		I		I	3-16
** STEERING HEAD BEARING			I		I		I		I	3-17

* SHOULD BE SERVICED BY AN AUTHORIZED HONDA DEALER, UNLESS THE OWNER HAS PROPER TOOLS AND SERVICE DATA AND IS MECHANICALLY QUALIFIED.

** IN THE INTEREST OF SAFETY, WE RECOMMEND THESE ITEMS BE SERVICED ONLY BY AN AUTHORIZED HONDA DEALER.

- NOTE .
1. Service more frequently when riding in dusty areas.
 2. Service more frequently when riding in rain or at full throttle, or after the motorcycle has been washed or overturned.
 3. For higher odometer readings, repeat at the frequency interval established here.



ENGINE OIL RECOMMENDATION

Use HONDA 4-STROKE OIL or equivalent.
API SERVICE CLASSIFICATION: SE or SF
Viscosity: SAE10W-40

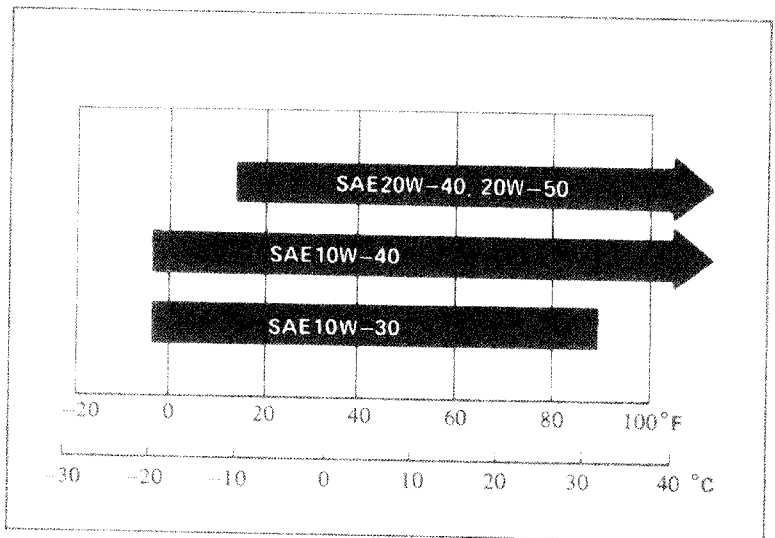

SPARK PLUGS

RECOMMENDED SPARK PLUGS:

	Standard	For extended high speed riding
NGK	DR8ES-L	DR8ES
ND	X24ESR-U	X27ESR-U

Clean any dirt from around the spark plug base.
Disconnect the spark plug caps.
Remove and discard the spark plugs.
Measure the new spark plug gaps using a wire-type feeler gauge.

SPARK PLUG GAP: 0.6–0.7 mm
(0.024–0.028 in)

Adjust by bending the side electrode carefully.
With the plug washer attached, thread the spark plugs in by hand to prevent cross-threading.
Tighten the spark plugs another 1/2 turn with a spark plug wrench to compress the plug washer.
Connect the spark plug caps.

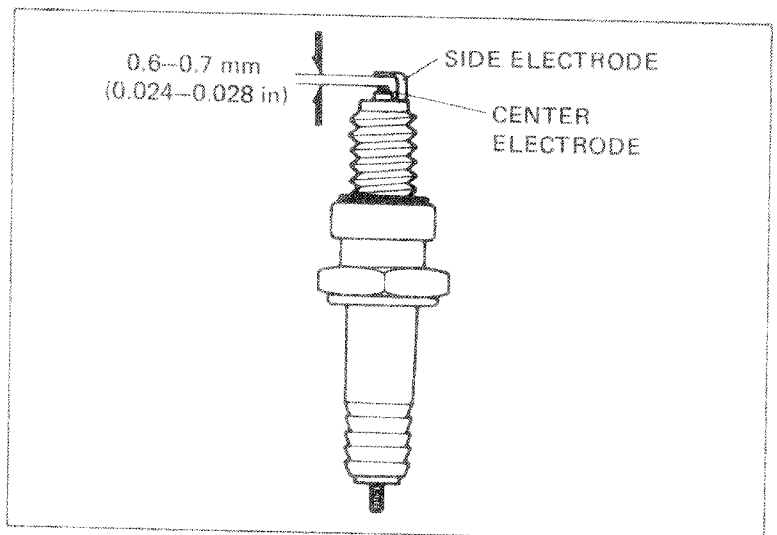



FUEL STRAINER

Turn the fuel valve OFF.

Remove the fuel cup, O-ring and filter screen, draining the gasoline into a suitable container.

WARNING

Gasoline is flammable and is explosive under certain conditions.

Do not smoke or allow flames or sparks near the equipment while draining fuel.

Wash the fuel cup and filter screen in clean non-flammable or high flash point solvent.

Reinstall the filter screen, aligning the index marks on the fuel valve body and the filter screen. Install a new O-ring into the fuel valve body.

Reinstall the fuel cup, making sure the new O-ring is in place.

Finger-tighten the cup, then torque it to specification.

Torque: 3–5 N·m (0.3–0.5 kg·m, 2–4 ft·lb)

After installing, turn the fuel valve ON and check that there are no fuel leaks.

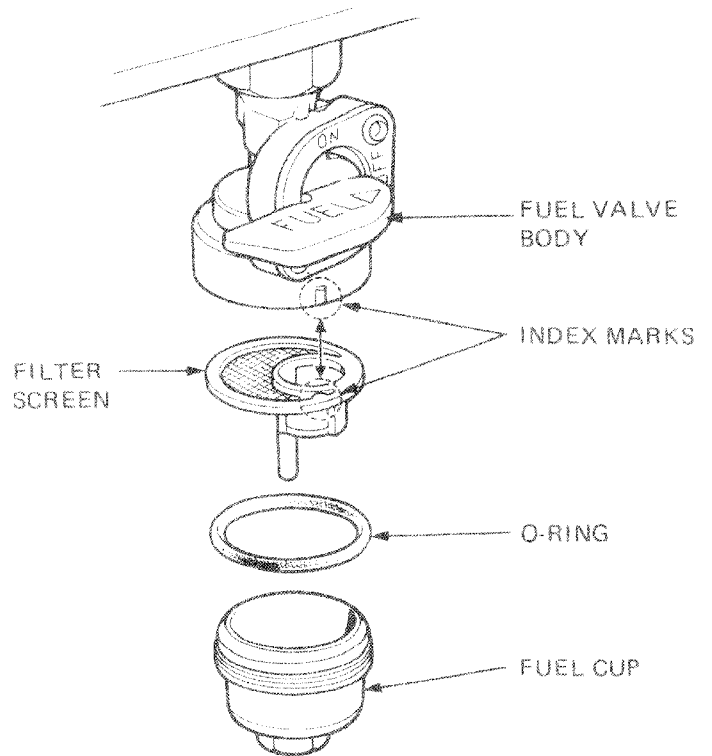

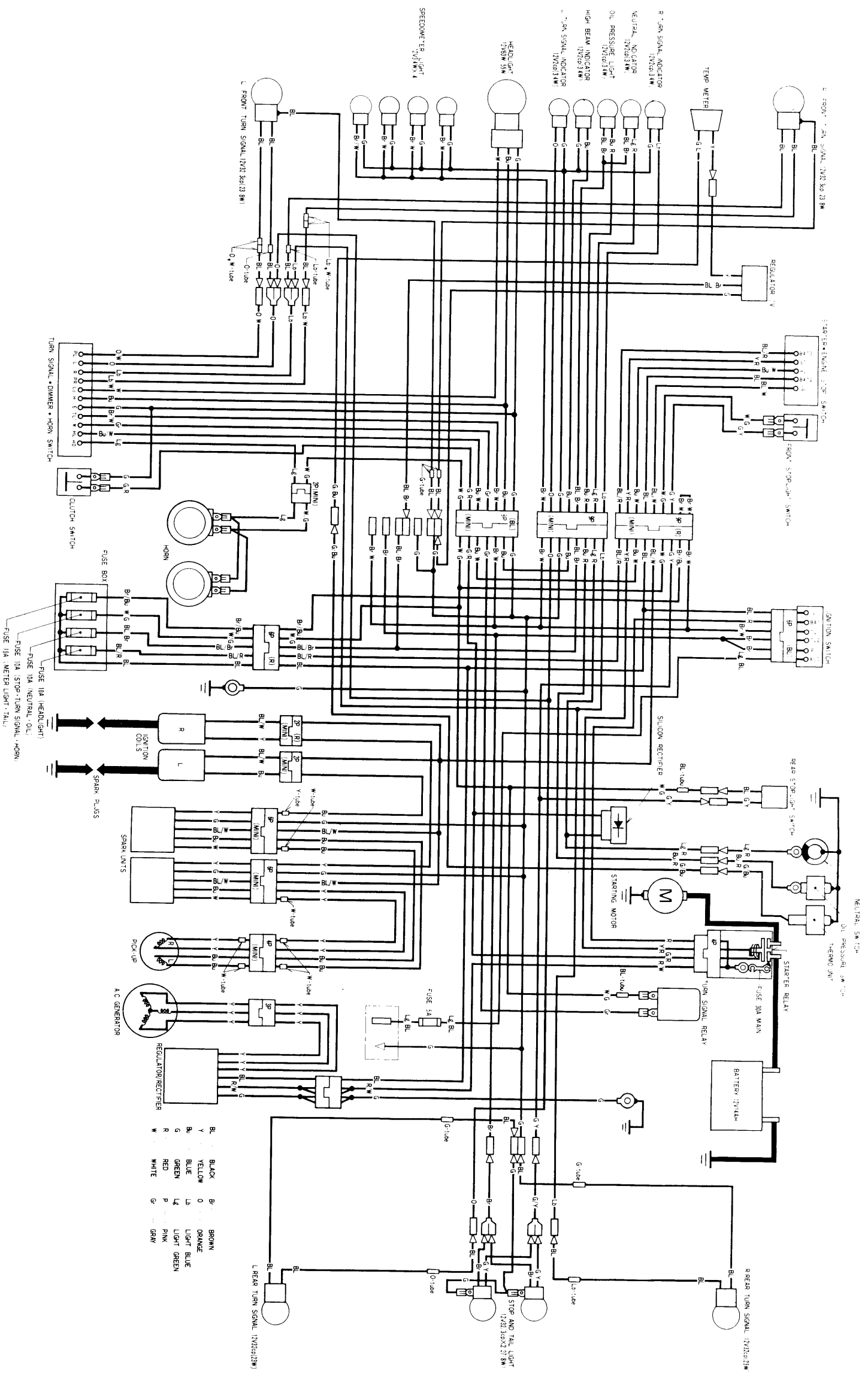

- BL BLACK
- Y YELLOW
- BK BLUE
- G GREEN
- R RED
- W WHITE
- BR BROWN
- O ORANGE
- LB LIGHT BLUE
- LG LIGHT GREEN
- P PINK
- GR GRAY

IGNITION SWITCH

BATT (G)	ACC (TL)	TL2 (R)
LOCK		
OFF		
ON		
P		

STARTER SWITCH

BATT (G)	ACC (TL)	TL2 (R)
LOCK		
OFF		
ON		
P		

TURN SIGNAL SWITCH

W (L)	R (R)	TL (L)	TR (R)	HL (L)	HR (R)	LD (L)	RD (R)
OFF							
ON							
P							

HORN SWITCH

W (L)	R (R)	TL (L)	TR (R)	HL (L)	HR (R)	LD (L)	RD (R)
OFF							
ON							
P							

0030Z—MA1—7300

GL500 INTERSTATE

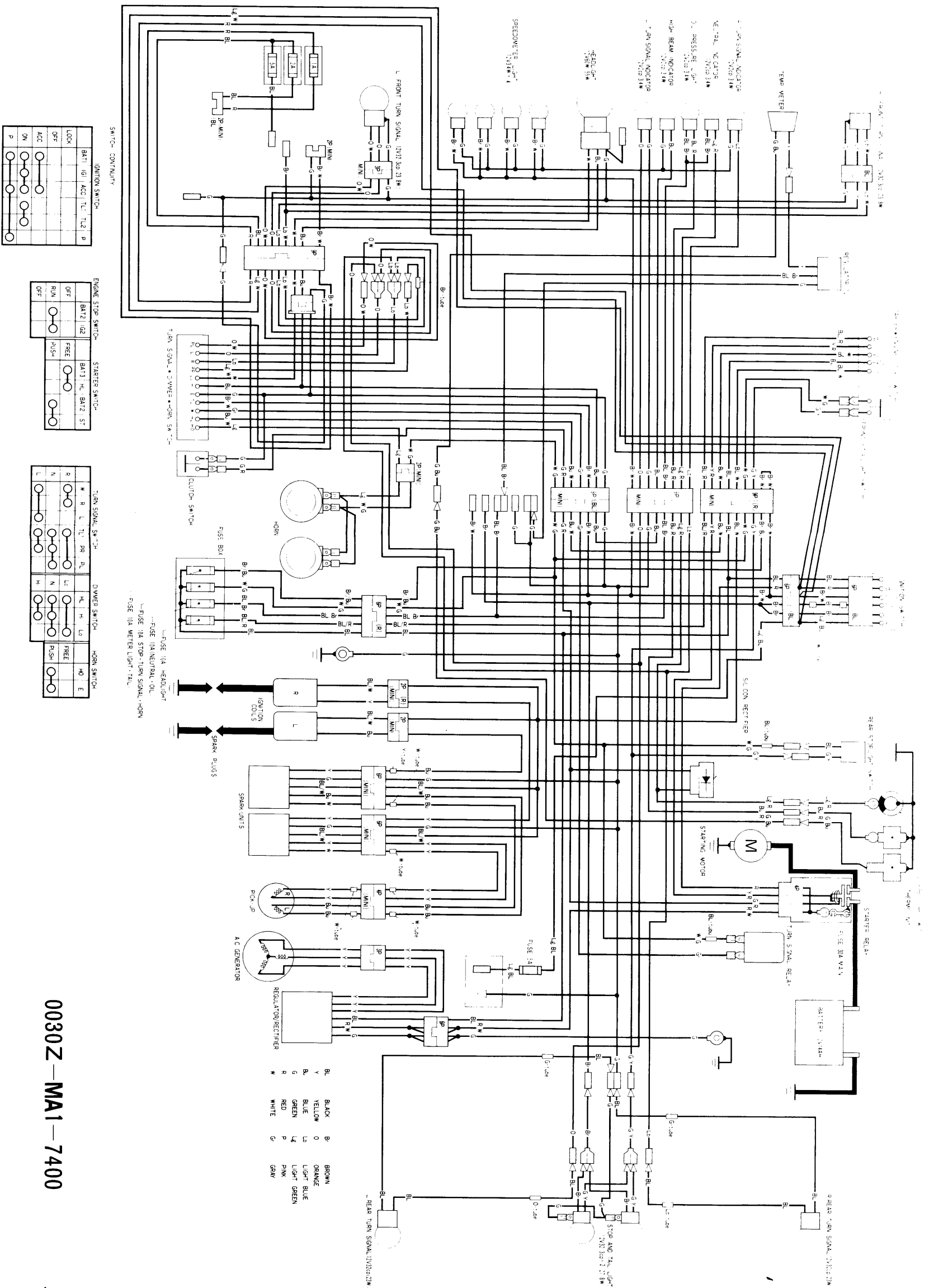

0030Z—MA1—7400



INTRODUCTION

This Addendum contains information for the 1983 GL650/GL650 Interstate.

Refer to the GL500 base shop manual and '82 Addendum for service procedures and data not included.

All information, illustrations, directions and specifications included in this publication are based on the latest product information available at the time of approval for printing. Honda Motor Co., Ltd. reserves the right to make changes at any time without notice and without incurring any obligation whatever. No part of this publication may be reproduced without written permission.

HONDA MOTOR CO., LTD.
Service Publications Office

CONTENTS

- 1. MODEL IDENTIFICATION 24-2
- 2. GENERAL INFORMATION 24-3
- 3. SERVICE DATA 24-7
- 4. LUBRICATION 24-10
- 5. MAINTENANCE 24-11
- 6. FUEL SYSTEM 24-12
- 7. CLUTCH/OIL PUMP 24-20
- 8. COOLING SYSTEM 24-22
- 9. CAM CHAIN 24-27
- 10. TRANSMISSION 24-29
- 11. FRONT WHEEL/SUSPENSION 24-30
- 12. REAR WHEEL 24-32
- 13. SWITCHES 24-33
- 14. WIRING DIAGRAMS 24-34



1. MODEL IDENTIFICATION

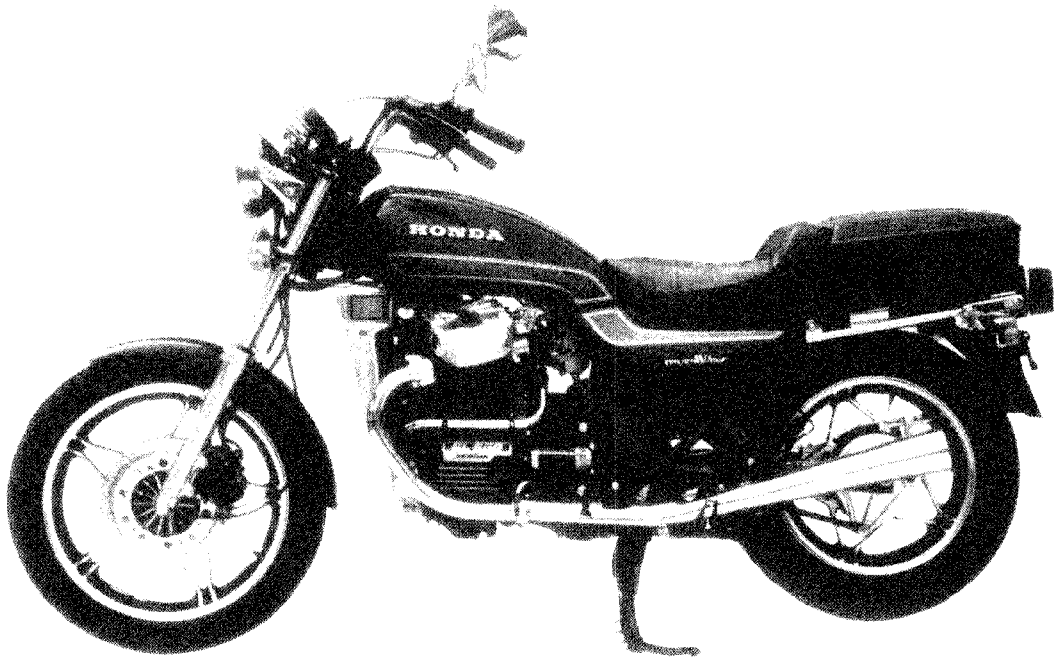

GL650 BEGINNING WITH F/N CR100 + DM00004

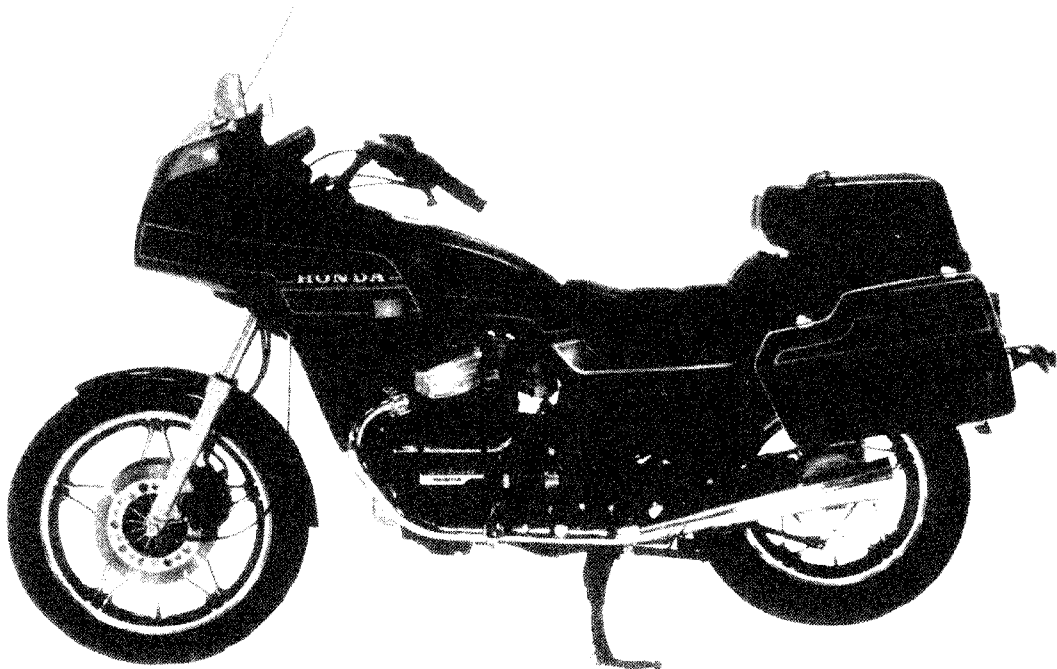

GL500 INTERSTATE BEGINNING WITH F/N RC101 + DM00015



2. GENERAL INFORMATION

SPECIFICATIONS

The specifications listed are new for 1983. Refer to the base manual for specifications not listed here.

	Item	GL650	GL650 INTERSTATE
DIMENSIONS	Overall length	2,215 mm (87.2 in)	2,305 mm (90.7 in)
	Overall width	890 mm (35.0 in)	885 mm (34.8 in)
	Overall height	1,184 mm (46.6 in)	1,480 mm (58.3 in)
	Seat height	775 mm (30.5 in)	770 mm (30.3 in)
	Foot peg height	320 mm (12.6 in)	315 mm (12.4 in)
	Ground clearance	150 mm (5.9 in)	145 mm (5.7 in)
	Dry weight	217 kg (478 lbs)	240 kg (529 lbs)
	Curb weight (Wet)	234 kg (516 lbs)	257 kg (567 lbs)
FRAME	F. suspension, travel	Telescopic, 150 mm (5.9 in)	
	R. suspension, travel	Swing arm, 110 mm (4.3 in)	
	F. suspension air pressure	40-120 kPa (0.4 - 1.2 kg/cm ² , 5.5 - 17 psi)	
	R. suspension air pressure	0 - 500 kPa 100 - 500 kPa	
	Front tire size	3.50 H-19-4PR Tubeless	
	Rear tire size	120/90-16 67H Tubeless	
Cold tire pressures	up to 90 kg (200 lbs) load	Front	225 kPa (2.25 kg/cm ² , 32 psi)
		Rear	225 kPa (2.25 kg/cm ² , 32 psi)
	Up to vehicle capacity load	Front	225 kPa (2.25 kg/cm ² , 32 psi)
		Rear	280 kPa (2.80 kg/cm ² , 40 psi)
	F. brake and lining swept area (dual discs)	Disc brakes 952 cm ² (147.6 sq. in.)	
	Front fork oil capacity	275 cc (9.3 oz) ATF after disassembly ATF after draining	
	Rear shock oil capacity	669 cc (22.6 oz) ATF	
ENGINE	Engine weight	82.5 x 63 mm (3.248 x 2.480 in)	
	Bore and stroke	674 cm ³ (41.3 cu-in)	
	Displacement	9.8:1	
	Compression ratio	3.6 lit (3.8 US qt, 3.1/Imp qt) after disassembly	
	Oil capacity	3.0 lit (3.1 US qt, 2.6/Imp qt) after draining	
	Oil type	SAE 10W-40 SE or SF, Honda 4-stroke oil or equivalent	

TOOLS

Tool Description	Tool #
Fork seal driver	07947 - 3710101

Item		GL650	GL650 INTERSTATE
ENGINE	Valve clearance (cold) IN EX	0.10 mm (0.004 in) 0.12 mm (0.005 in)	
CARBURETION	Carburetor type Identification number Pilot screw	VB type, 35 mm (1.4 in) venturi bore VB2AA See page 24-12	
DRIVE TRAIN	Primary reduction ratio Gear ratio 1st Gear ratio 2nd Gear ratio 3rd Gear ratio 4th Gear ratio 5th Final reduction ratio	2.144 (35/74) 2.500 (16/40) 1.714 (21/36) 1.280 (25/32) 1.036 (28/29) 0.839 (31/26) 3.091 (34/11)	
ELECTRICAL	Spark plug Standard For extended high speed riding	X24EPR-U9 (ND) or DPR8EA-9 (NGK) X27EPR-U9 (ND) or DPR9EA-9 (NGK)	
	Spark plug gap Fuse	0.8 - 0.9 mm (0.031 - 0.035 in) 30A (Main) 15A (Sub)	
LIGHTS	Rear turn signal light Meter light Neutral indicator Turn signal indicator High beam indicator Oil pressure warning light	12V-32 cp No. 1037 12V-2 cp No. 158	



HONDA

GL650
GL650 INTERSTATE

'83 ADDENDUM

CABLE AND HARNESS ROUTING

(GL650)

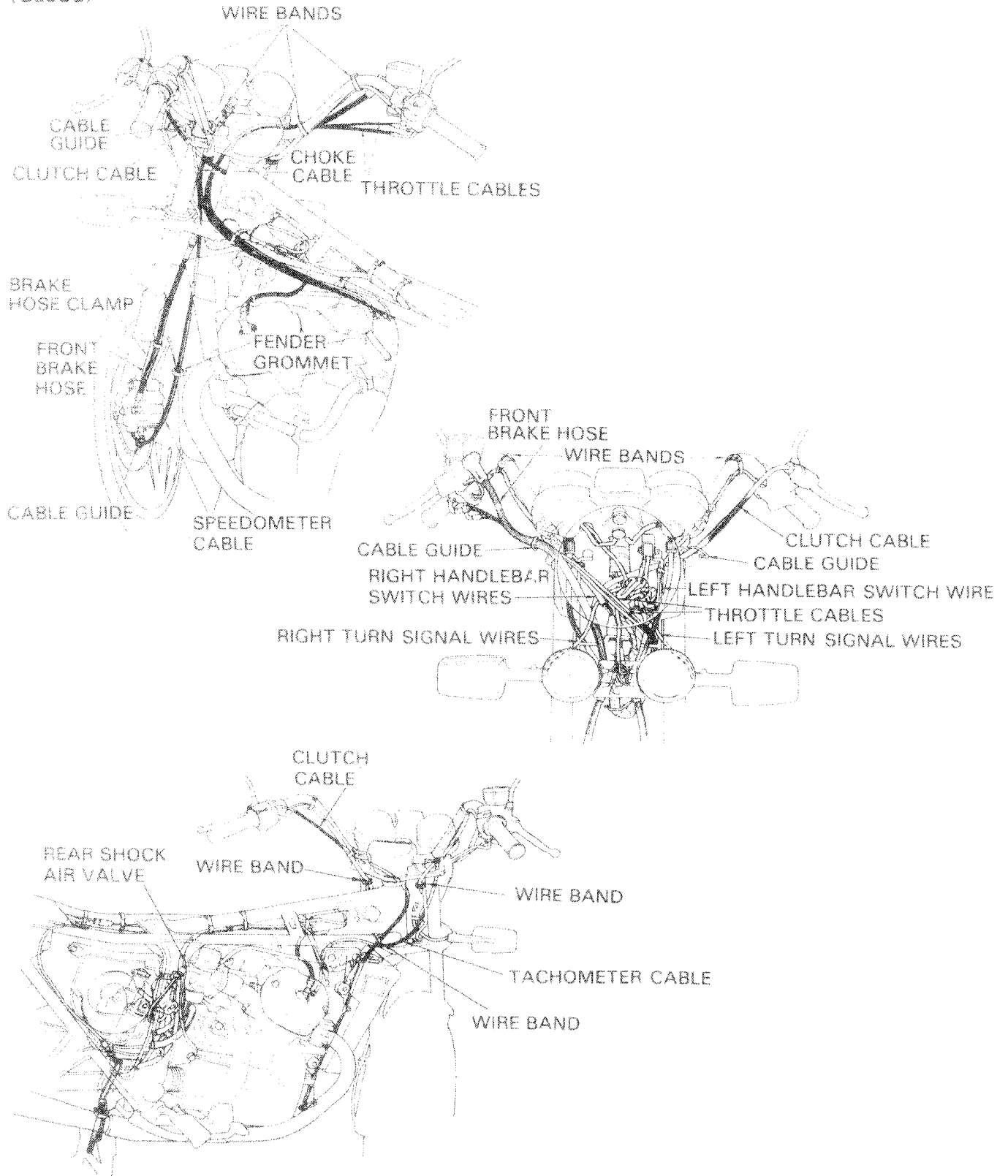



(GL650 INTERSTATE)

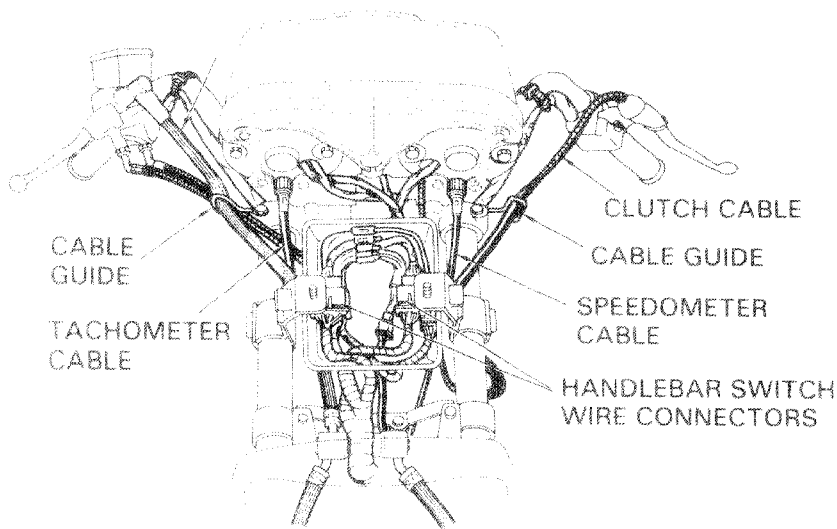
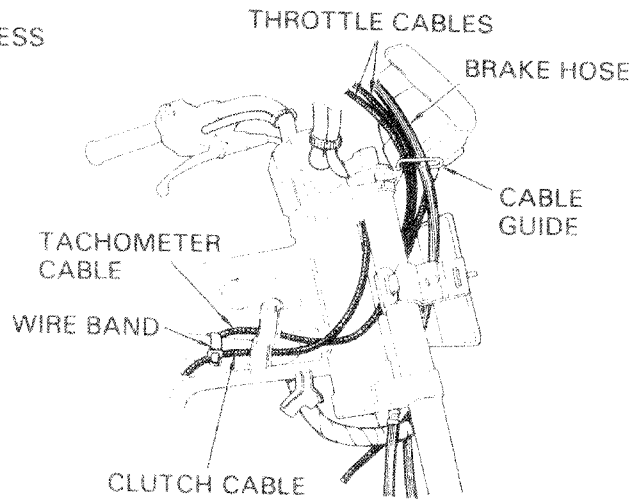
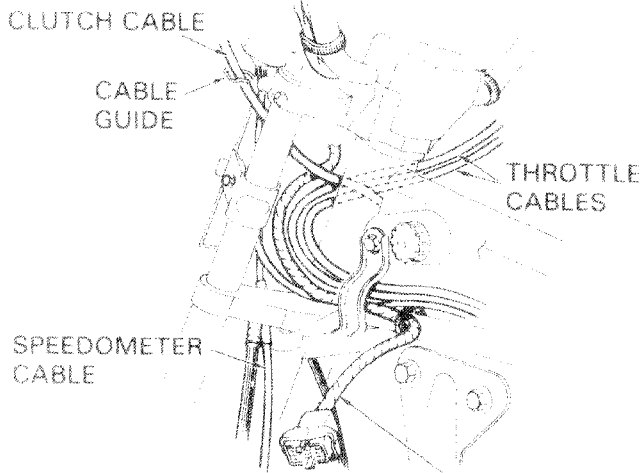



3. SERVICE DATA

Unit: mm (in.)

ITEM		STANDARD	SERVICE LIMIT	
Cylinder compression (cold)		1,200 kpa (1.20 kg/cm ² , 171 psi)	—————	
Rocker arms, shafts, and holders	Rocker arm I.D.	15.00-15.018 (0.5906-0.5913)	15.04 (0.592)	
	Rocker arm shaft O.D.	14.966-14.984 (0.5892-0.5899)	14.95 (0.589)	
	Rocker arm holder I.D.	14.988-15.006 (0.5901-15.908)	15.03 (0.592)	
Valve spring	Free length	Outer (IN)	50.40 (1.984)	
		Inner (IN)	50.30 (1.980)	
		Outer (EX)	50.40 (1.984)	
		Inner (EX)	50.30 (1.980)	
	Assembled length	Outer (IN)	28 kg/39.9 mm (61.71 lbs/1.5709 in)	26.5 kg/39.8 mm (58.4 lbs/1.5670 in.)
		Inner (IN)	11.5 kg/37.9 mm (25.4 lbs/1.4921 in)	10.5 kg/37.9 mm (23.2 lbs/5.4291 in)
		Outer (EX)	28.5 kg/39.9 mm (62.8 lbs/1.5709 in)	26.5 kg/39.8 mm (58.4 lbs/1.5670 in)
		Inner (EX)	11.5 kg/37.9 mm (25.4 lbs/1.492 in)	10.5 kg/37.9 mm (23.2 lbs/1.4921 in)
Valves and valve guides	Stem O.D.	(IN)	6.580-6.590 (0.2591-0.2594)	
		(EX)	6.550-6.560 (0.2579-0.2583)	
	Guide I.D.	(IN)	6.600-6.620 (0.2598-0.2606)	
		(EX)	6.600-6.620 (0.2598-0.2506)	
	Stem-to-guide clearance	(IN)	—————	
		(EX)	—————	
Cylinder head	Valve seat width	1.1-1.3 (0.04-0.05)	2.0 (0.08)	
	Warpage	—————	0.10 (0.040)	
Clutch	Free play (at lever end)		10-20 (3/8-3/4)	
	Clutch spring	Free length	39.40 (1.551)	
		Tension	23.7-26.3 kg/28.0 mm (52.3-58.0 lbs/1.10 in)	
	Disc thickness	A	2.62-2.78 (0.103-0.109)	
		B	3.5 (0.14)	
	Plate warpage	A	—————	
		B	—————	
	Outer guide I.D.		25.000-25.025 (0.9843-0.9852)	
Outer guide O.D.		31.987-32.000 (1.2593-1.2598)		
Oil pump	Inner-to-outer rotor clearance		—————	
	Outer rotor-to-body clearance		—————	
	Rotor-to-body clearance		—————	
Oil pressure	Relief valve relief pressure		500-600 kpa (5.0-6.0 kg/cm ² , 71-85 psi)	

Unit: mm (in)

ITEM		STANDARD	SERVICE LIMIT
Camshaft	Cam height	IN	37.988 (1.4956)
		EX	38.143 (1.5017)
	Journal O.D.	Front	21.959-21.980 (0.8645-0.8654)
		Rear	25.959-26.980 (1.0220-1.0622)
Rocker arms and shafts	Arm I.D.	14.016-14.027 (0.5518-0.5522)	
	Shaft O.D.	13.982-14.000 (0.5506-0.5512)	
	Camshaft holder I.D.	22.000-22.021 (0.8661-0.8670)	
	Camshaft bearing I.D.	26.000-26.021 (1.0236-1.0244)	
Transmission	M4 and M5 gear I.D.	29.020-29.041 (1.1425-1.1433)	
	C1 gear I.D.	24.020-24.041 (0.9457-0.9465)	
	C2 gear I.D.	31.025-31.050 (1.2215-1.2224)	
	C3 gear I.D.	29.020-29.041 (1.1425-1.1433)	
	C1 gear bushing I.D.	24.985-25.006 (0.9837-0.9845)	
	C1 gear bushing O.D.	28.979-29.000 (1.1409-1.1417)	
	Mainshaft O.D. and Countershaft O.D.	See page 24-29	
	Gear-to-bushing clearance	—————	
Shift drum	O.D.	34.950-34.975 (1.3760-1.3770)	
	I.D.	35.000-35.025 (1.3780-1.3789)	
Shift fork	Claw thickness	5.930-6.000 (0.233-0.236)	
	I.D.	13.000-13.018 (0.5118-0.5125)	
Fork shaft	O.D.	12.966-12.984 (0.5105-0.5112)	
Final shaft spring	Free length	73.0 (2.87)	
Crankshaft	Main journal oil clearance	0.020-0.060 (0.0008-0.0023)	
	Crankpin oil clearance	0.020-0.044 (0.0008-0.0017)	
	Connecting rod side clearance	0.150-0.170 (0.0059-0.0067)	
Cylinder	I.D.	82.500-82.515 (3.2480-3.2486)	
	Warpage	—————	
Piston ring	Ring-to-groove clearance	Top	0.015-0.050 (0.0006-0.0020)
		Second	0.015-0.050 (0.0006-0.0020)
	Ring end gap	Top	0.10-0.25 (0.004-0.010)
		Second	0.10-0.25 (0.004-0.010)
	Oil (side rail)	0.3-0.9 (0.012-0.035)	
Piston/ Piston pin	Piston O.D.	82.460-82.485 (3.2465-3.2474)	
	Piston pin bore	21.002-21.008 (0.8268-0.8271)	
	Piston pin O.D.	20.994-21.000 (0.8265-0.8268)	
	Small end I.D.	21.020-21.041 (0.8276-0.8284)	
	Piston-to-cylinder clearance	—————	

**HONDA**GL650
GL650 INTERSTATE**'83 ADDENDUM**

Unit: mm (in)

ITEM		STANDARD	SERVICE LIMIT
Axle shaft runout (front)		—————	0.20 (0.008)
Front wheel rim runout	Radial	—————	2.0 (0.08)
	Axial	—————	2.0 (0.08)
Front fork spring free length	Upper	123.6 (4.87)	120.6 (4.75)
	Lower	466.9 (18.38)	451.8 (17.79)
Front fork tube runout		—————	0.20 (0.008)
Front fork oil capacity		275 cc (9.3 oz)	—————
Fork air pressure		40—120 kpa (0.4—1.2 kg/cm ² , 5.5—17 psi)	—————
Axle runout (rear)		—————	0.2 (0.008)
Rear wheel runout	Radial	—————	2.0 (0.08)
	Axial	—————	2.0 (0.08)
Brake lining thickness		4.9—5.0 (0.19—0.20)	2.0 (0.08)
Rear brake drum I.D.		160.0 (6.06)	161 (6.34)
Final drive	Backlash	0.08—0.18 (0.003—0.007)	0.25 (0.010)
	Backlash difference	—————	0.10 (0.004)
	Pinion gear preload	0.4—0.5 N·m (4.0—5.0 kg·cm, 3.48—4.32 in·lb)	—————
	Assembly preload	0.6—0.9 N·m (6.0—9.0 kg·cm, 5.16—7.80 in·lb)	—————
	Final gear oil capacity	160—180 cc (5.4—6.1 oz)	—————
Rear shock absorber oil capacity		669 cc (22.6 oz)	—————
Rear shock absorber air pressure	GL650	0—500 kpa (0—5.0 kg/cm ² , 0—70 psi)	—————
	GL650I	100—500 kpa (1.0—5.0 kg/cm ² , 14—70 psi)	—————
Disc thickness	GL650	6.9—7.1 (0.27—0.28)	6.0 (0.24)
	GL650I	4.9—5.1 (0.19—0.20)	4.0 (0.16)
Disc runout		—————	0.3 (0.01)
Master cylinder I.D.	GL650	15.870—15.913 (0.6248—0.6265)	15.925 (0.6270)
	GL650I	14.000—14.043 (0.5512—0.5529)	14.055 (0.5533)
Master piston O.D.	GL650	15.827—15.854 (0.6231—0.6242)	15.815 (0.6226)
	GL650I	13.957—13.984 (0.5495—0.5506)	13.945 (0.5490)
Caliper piston O.D.		30.148—30.198 (1.1869—1.1889)	30.140 (1.1866)
Caliper cylinder I.D.		30.230—30.280 (1.1901—1.1921)	30.290 (1.1925)
Starter motor	Brush spring tension	0.495—0.605 kg	400 kg
	Brush length	11.0—12.5 (0.43—0.49)	5.5 (0.21)



4. LUBRICATION

OIL STRAINER CLEANING

Drain the engine oil.

Remove the oil pan by removing the eight bolts.

NOTE

Loosen the bolts in an X pattern in two or more steps.

Remove the oil strainer from the engine case.

Clean the oil strainer screen and oil pan thoroughly.

Inspect the O-ring for damage or deterioration. Replace if necessary.

Install the strainer in the oil pan.

NOTE

Align the tabs of the strainer body with the lug in the oil pan.

Install the oil pan on the engine case, inserting the end of the strainer into the oil pump inlet.

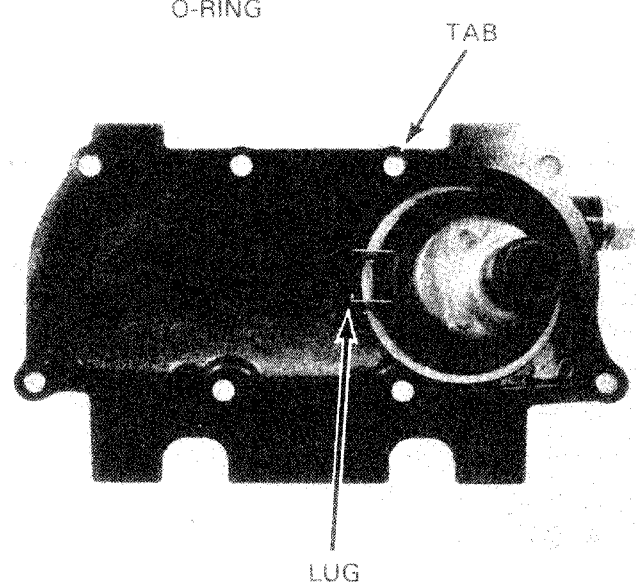
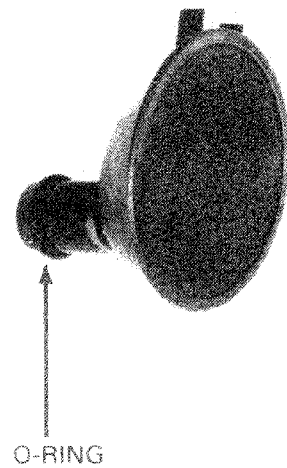
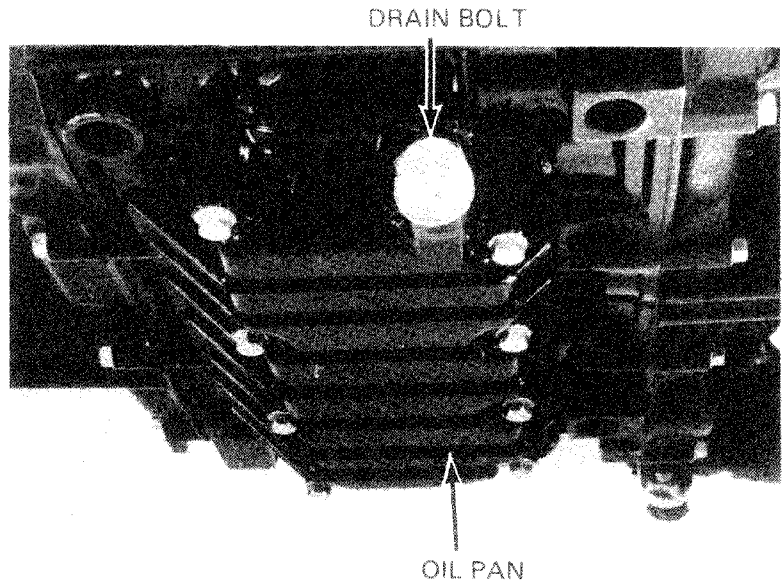



5. MAINTENANCE

MAINTENANCE SCHEDULE

Perform the Pre-ride Inspection in the Owner's Manual at each scheduled maintenance period.

I : INSPECT AND CLEAN, ADJUST, LUBRICATE, OR REPLACE IF NECESSARY.

C : CLEAN

R : REPLACE

A : ADJUST

L : LUBRICATE

	ITEM	FREQUENCY	WHICHEVER COMES FIRST EVERY	ODOMETER READING (NOTE 3)								Refer to page
				600mi (1,000km)	4,000mi (6,400km)	8,000mi (12,800km)	12,000mi (19,200km)	16,000mi (25,600km)	20,000mi (32,000km)	24,000mi (38,400km)	38,400mi (61,600km)	
EMISSION RELATED ITEMS	* FUEL LINES					I		I		I	3-4	
	* FUEL STRAINER			C	C	C	C	C	C	C	23-6	
	* THROTTLE OPERATION			I		I		I		I	3-4	
	* CARBURETOR-CHOKE					I		I		I	3-5	
	AIR CLEANER	NOTE 1			C	R	C	R	C	R	3-5	
	CRANKCASE BREATHER	NOTE 2			C	C	C	C	C	C	3-6	
	SPARK PLUGS				R	R	R	R	R	R	23-7	
	* VALVE CLEARANCE			I	I	I		I		I	3-7	
	ENGINE OIL	YEAR		R		R		R		R	2-2	
	ENGINE OIL FILTER	YEAR		R		R		R		R	2-2	
	* CARBURETOR-SYNCHRONIZE			I		I		I		I	3-9	
	* CARBURETOR-IDLE SPEED			I	I	I	I	I	I	I	3-10	
	RADIATOR COOLANT					I		I		*R	3-10	
	* RADIATOR CORE					I		I		I	3-10	
* COOLING SYSTEM, HOSES & CONNECTIONS			I		I		I		I	3-11		
NON-EMISSION RELATED ITEMS	* DRIVESHAFT JOINT					L		L		L	2-3	
	FINAL DRIVE OIL					I		I		R	2-3	
	BATTERY	MONTH		I	I	I	I	I	I	I	3-11	
	BRAKE FLUID (FRONT)	MONTH I 2 YEARS *R		I	I	I	I	I	I	*R	3-11	
	BRAKE SHOE/PAD WEAR				I	I	I	I	I	I	3-12	
	BRAKE SYSTEM (REAR)			I		I		I		I	3-12	
	BRAKE LIGHT SWITCH			I		I		I		I	3-13	
	* HEADLIGHT AIM			I		I		I		I	3-13	
	CLUTCH			I	I	I	I	I	I	I	3-14	
	SIDE STAND					I		I		I	3-14	
	* SUSPENSION			I		I		I		I	3-15	
	* NUTS, BOLTS, FASTENERS			I		I		I		I	3-16	
	** WHEELS			I		I		I		I	3-16	
** STEERING HEAD BEARING			I		I		I		I	3-17		

*SHOULD BE SERVICED BY AN AUTHORIZED HONDA DEALER, UNLESS THE OWNER HAS PROPER TOOLS AND SERVICE DATA AND IS MECHANICALLY QUALIFIED.

**IN THE INTEREST OF SAFETY, WE RECOMMEND THESE ITEMS BE SERVICED ONLY BY AN AUTHORIZED HONDA DEALER.

- NOTES:
1. Service more frequently when riding in dusty areas.
 2. Service more frequently when riding in rain or at full throttle, or after the motorcycle has been washed or overturned.
 3. For higher odometer readings, repeat at the frequency interval established here.

6. FUEL SYSTEM

SPECIFICATIONS

Venturi diameter	35 mm (1.4 in)
I.D. No.	VB 2 AA
Float level	15.5 mm (0.61 in)
Pilot screw initial opening	2
Idle speed	1,100 ± 100 rpm
Vacuum pressure difference between carburetors	40 mm (1.6 in) Hg
Throttle grip free play	2–6 mm ($\frac{1}{8}$ – $\frac{1}{4}$ in)

CARBURETOR SEPARATION

Remove the cotter pin from the accelerator pump rod.

Remove the plain washer, spring and spring collar.

Fold the throttle joint bolt locking washer tabs down.

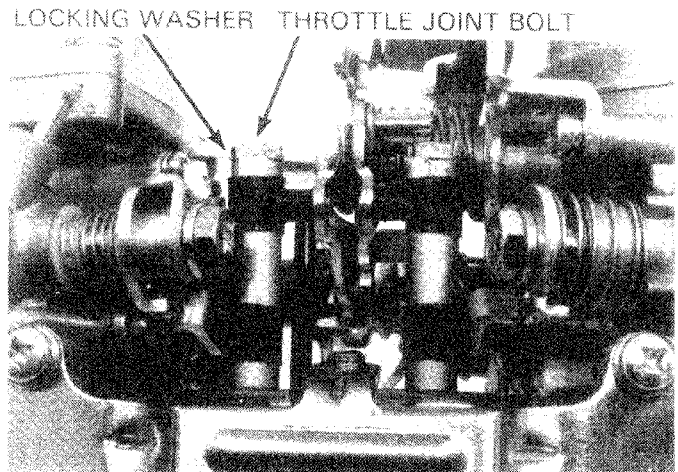
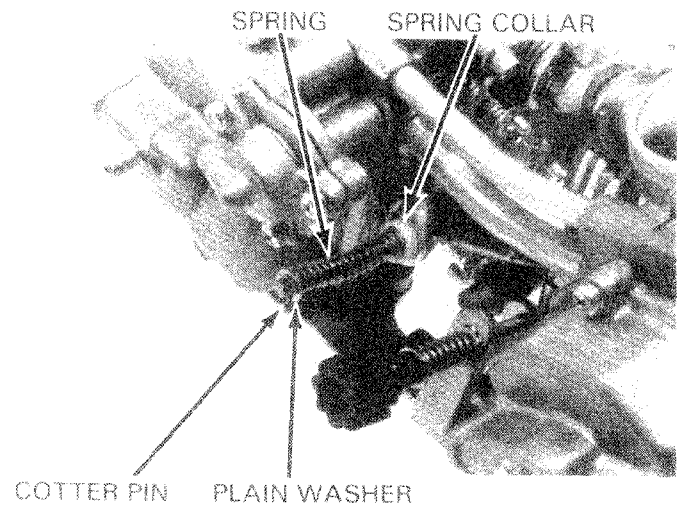



Loosen the throttle joint bolt.

Remove the locking washer and ball joint seat.

Disconnect the ball joint of the throttle link from the throttle joint pipe.

Remove the rod.

Disconnect the throttle joint pipe from the No. 3 carburetor throttle linkage.

Note each part location to insure original assembly.

NOTE

For easy removal, hold the joint pipe and turn the throttle link.

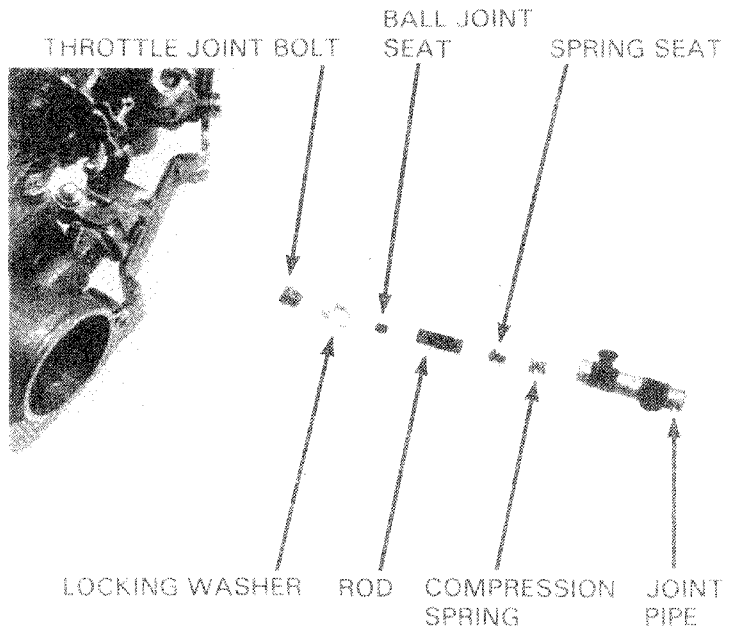

Remove the rear bracket.

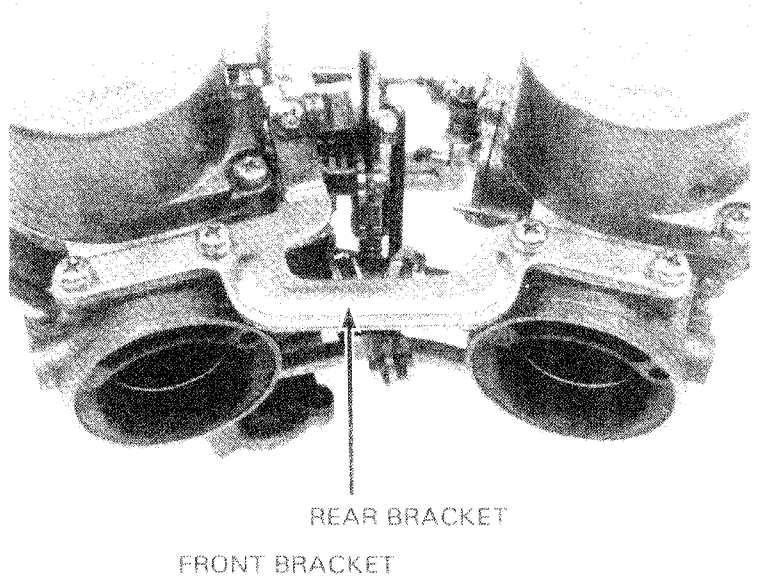

Remove the front bracket.

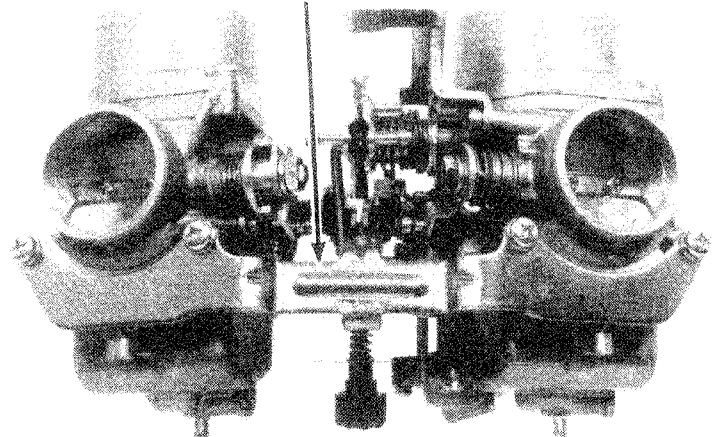

Carefully separate the carburetors.

CAUTION:

Separate the carburetor horizontally to prevent damage to the fuel and air joint pipes and choke links. Then, tilt the right carburetor assembly to clear the Accelerator pump rod.

Do not bend the accelerator pump rod.

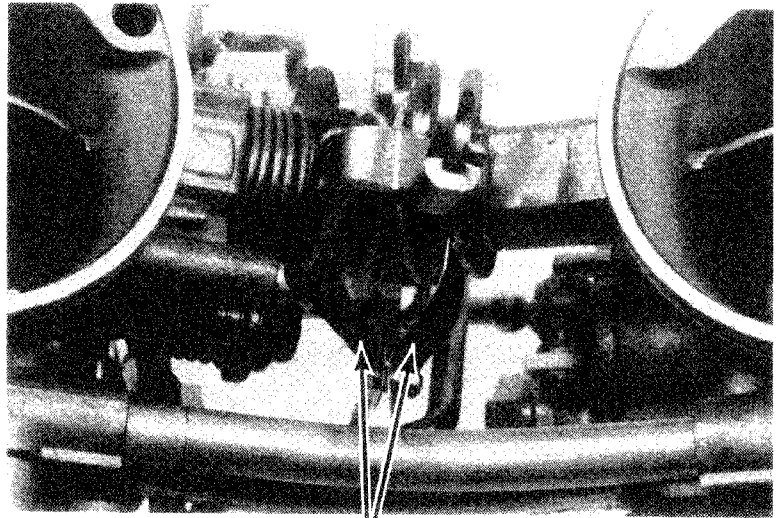

CHOKE LINKS

O-RINGS

Using compressed air, blow through the air and fuel passages to make sure they're clear.

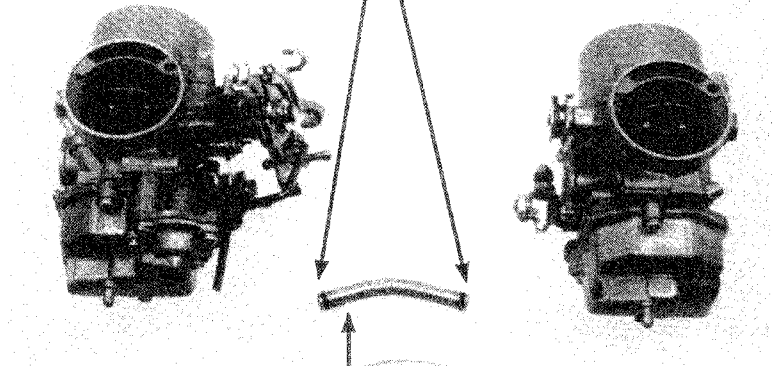

O-RING FUEL JOINT PIPES O-RING



CARBURETOR ASSEMBLY

The assembly sequence is essentially the reverse order of separation.

NOTE

Apply a thin coating of oil to the fuel joint O-rings.

TORQUE

Throttle joint: 2.8–4.2 N·m
(0.28–0.42 kg·m, 2–3 ft·lb)

Front and rear bracket: 2.8–4.2 N·m
(0.28–0.42 kg·m, 2–3 ft·lb)

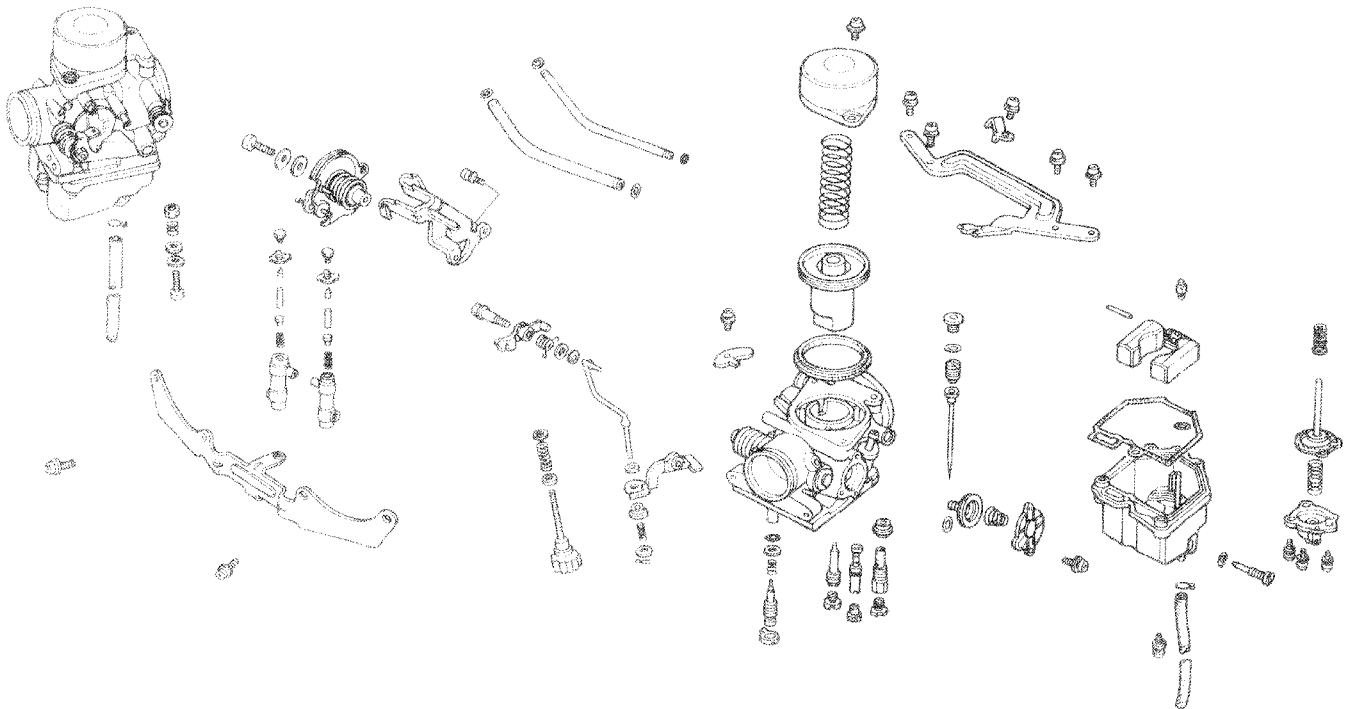

FAST IDLE ADJUSTMENT

FAST IDLE: 1,500–2,500 rpm

If fast idle adjustment is necessary, remove the carburetors. Then, unscrew the throttle stop screw until the throttle valve is completely closed.

Adjust by opening or closing the fork end of the choke link arm until the clearance between the choke link arm and the throttle drum is about 0.8 mm (0.047 in).

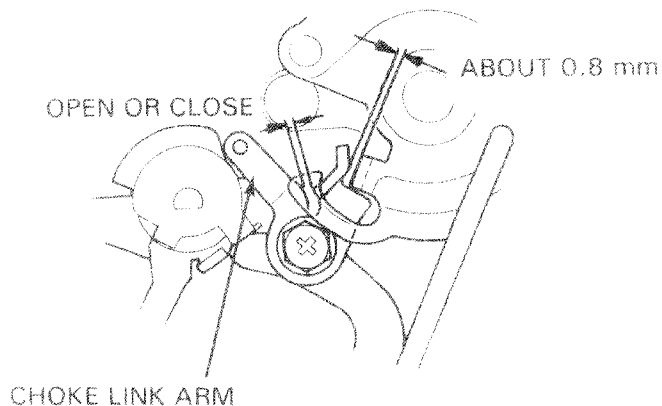

ACCELERATOR PUMP ADJUSTMENT

Loosen the throttle stop screw, until the throttle valve is completely closed.

Measure the clearance between the accelerator pump rod and the choke link arm with the throttle valve closed.

CLEARANCE: 0.1–0.3 mm
(0.004–0.012 in)

Adjust by bending the choke link arm.

Measure the clearance between the choke link arm and stopper on the carburetor.

CLEARANCE: 3.1–3.3 mm
(0.12–0.13 in)

Adjust by bending the choke link arm.

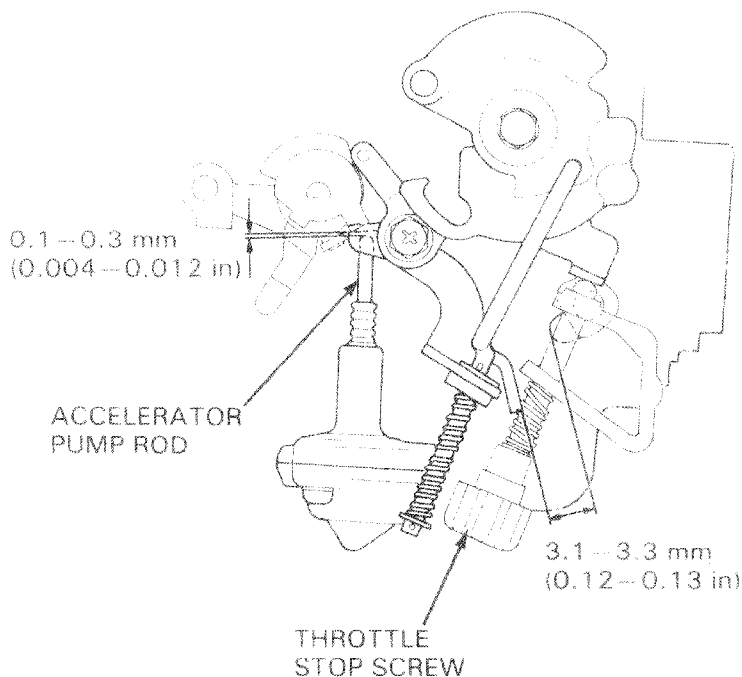

HIGH ALTITUDE ADJUSTMENT (USA ONLY)

When the vehicle is to be operated continuously above 6,500 ft (2,000 m) the carburetors must be readjusted as described below to improve driveability and decrease exhaust emissions.

1. Warm up the engine to operating temperature. Stop and go driving for 10 minutes is sufficient.
2. Turn each pilot screw clockwise 1/4 turn.
3. Adjust the idle speed to 1,100 ± 100 rpm with the throttle stop screw.

NOTE

These adjustments must be made at high altitude to ensure proper high altitude operation.



- Attach the Vehicle Emission Control Information Update label as shown. Refer to service Bulletin SL#132 for information on obtaining the label.

NOTE

Do not attach the label to any part that can be easily removed from the vehicle.

WARNING

Operation at an altitude lower than 5,000 ft (1,500 m) with the carburetors adjusted for high altitudes may cause the engine to idle roughly and stall.

When the vehicle is to be operated continuously below 5,000 ft (1,500 m) turn each pilot screw counterclockwise to its original position against its stop and adjust the idle speed to $1,100 \pm 100$ rpm. Be sure to do these adjustments at low altitude.

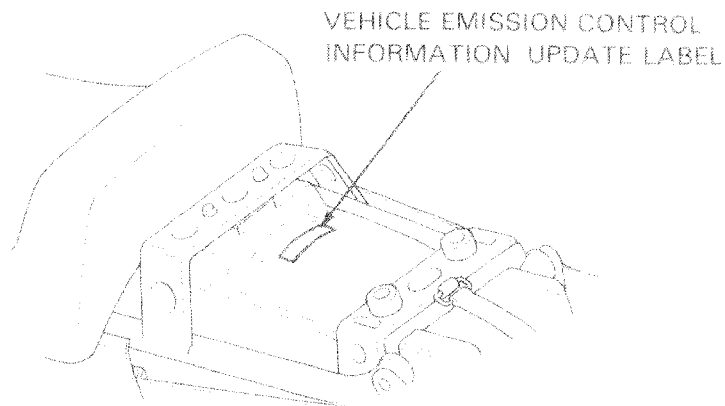

AIR CLEANER CASE REMOVAL

Remove the battery, then remove the 6 mm battery bracket bolt.

Loosen the seal band screw.

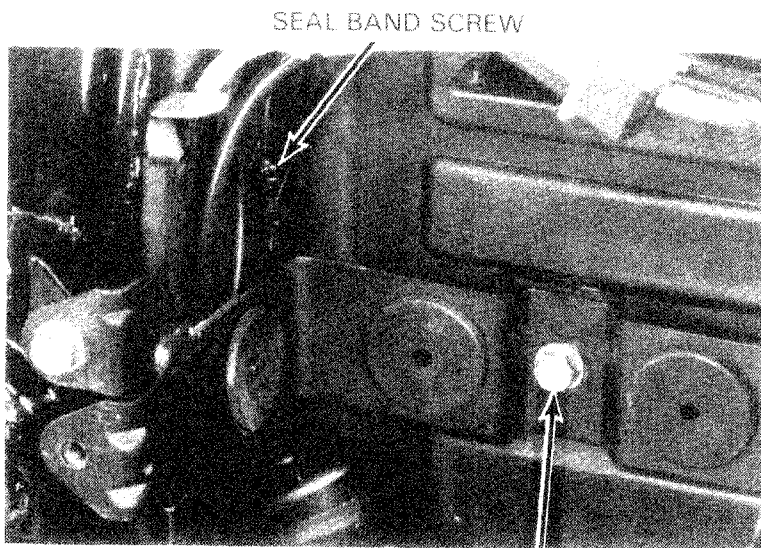

INTAKE TUBE BAND SCREW

Loosen the intake band (air cleaner side) screws.

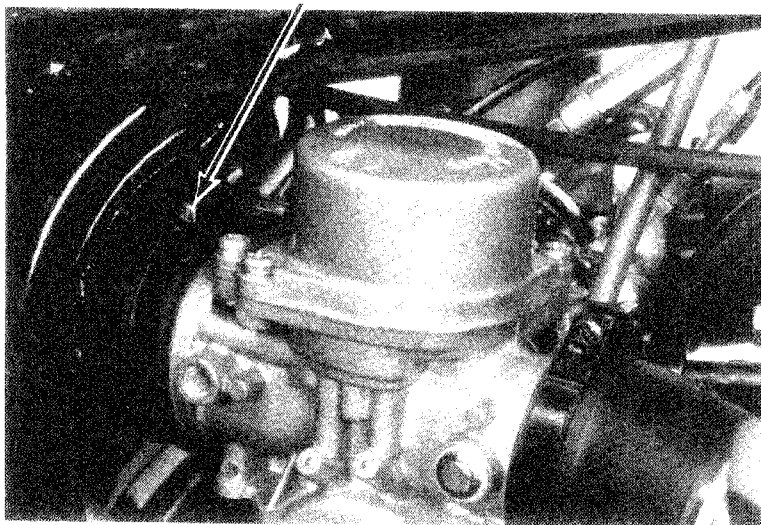

Remove the three 6 mm bolts and air cleaner case bracket.

Disconnect the breather separator tube from the air cleaner case and remove the air cleaner case from the right side.

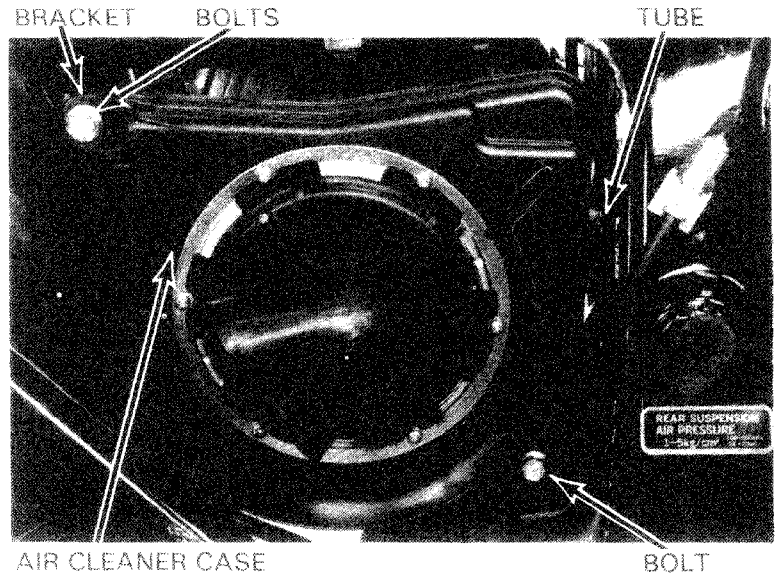

Disconnect the breather tube and drain tube from the breather separator.

Remove the breather separator.

Remove the carburetor plenum / intake tubes.

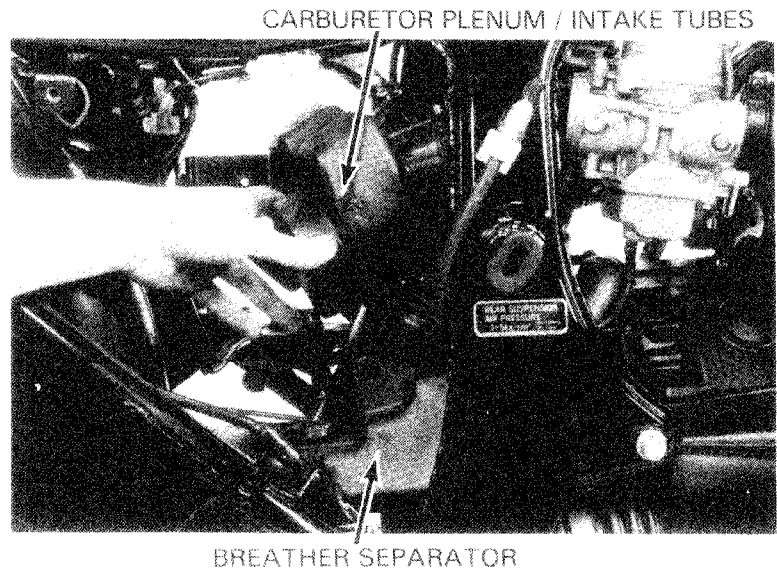

AIR CLEANER CASE INSTALLATION

Installation of the air cleaner case is essentially the reverse order of removal.

NOTE

If you must separate the plenum connector from the air cleaner, apply a sealant when you reassemble.
The arrow on the carburetor intake tubes must point down.

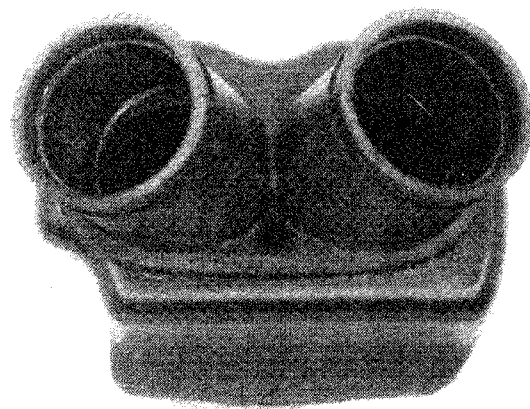



HONDA

GL650
GL650 INTERSTATE

'83 ADDENDUM

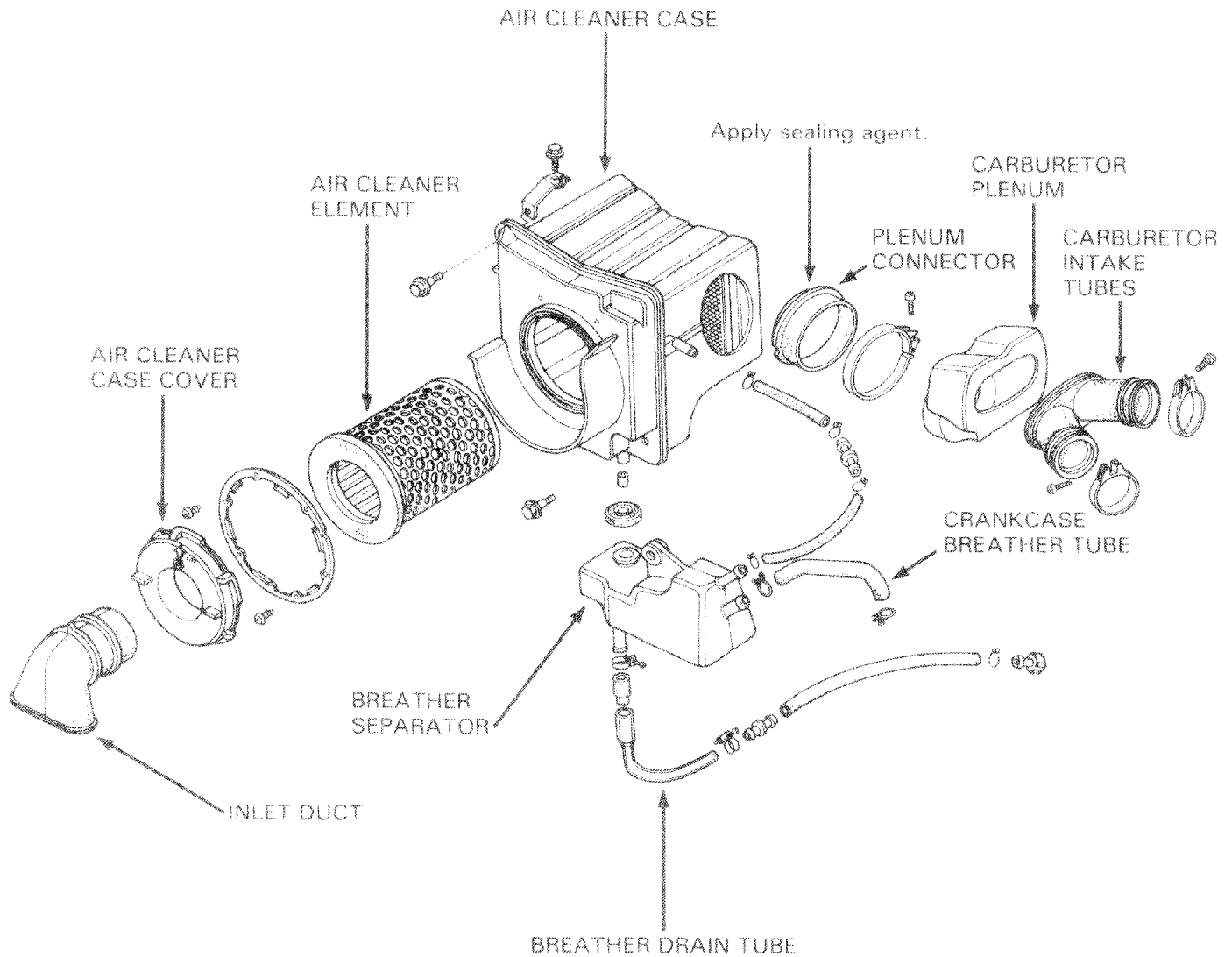



'83 ADDENDUM

**7. CLUTCH/OIL PUMP
CLUTCH OUTER REPLACEMENT
AND INSPECTION**

Remove the clutch cover.

Remove the lifter plate and spring.

Remove the lock nut and lock washer.

Remove the pressure plate, discs, plates and clutch center as a unit.

Remove the clutch outer guide and clutch outer.

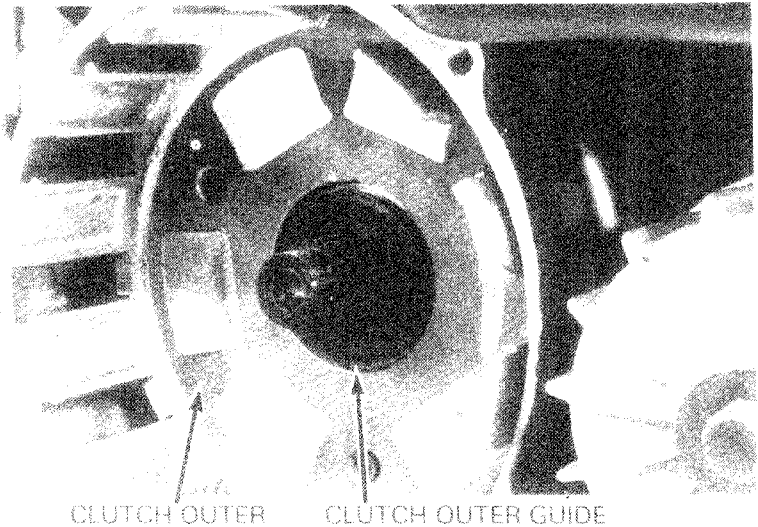

Remove the thrust washer.

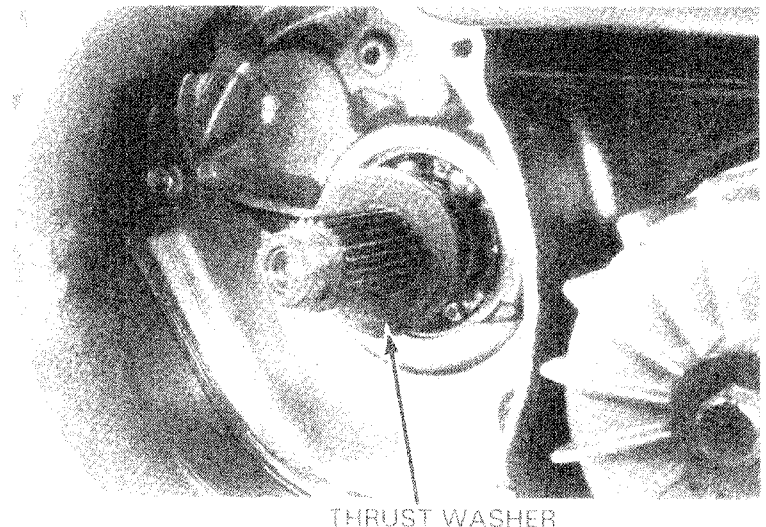

Check the slots in the clutch outer for nicks, cuts or indentations made by the friction discs.

Check the clutch outer needle bearing for damage or excessive play.

If the needle bearing is difficult to remove from the clutch housing, use the following tools:

Driver: 07749-0010000

Attachment, 42 x 47 mm:
07746-0010300

Pilot, 35 mm: 07746-0040800

Measure the O.D. of the outer guide.

SERVICE LIMIT:
31.928 mm (1.2570 in)

Measure the I.D. of the outer guide.

SERVICE LIMIT:
25.07 mm (0.9870 in)

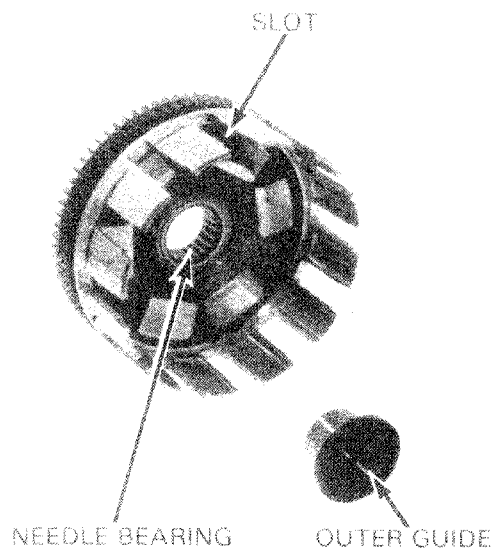



Align the teeth on the sub gear and primary drive gear.

Install the clutch outer in essentially the reverse order of removal.

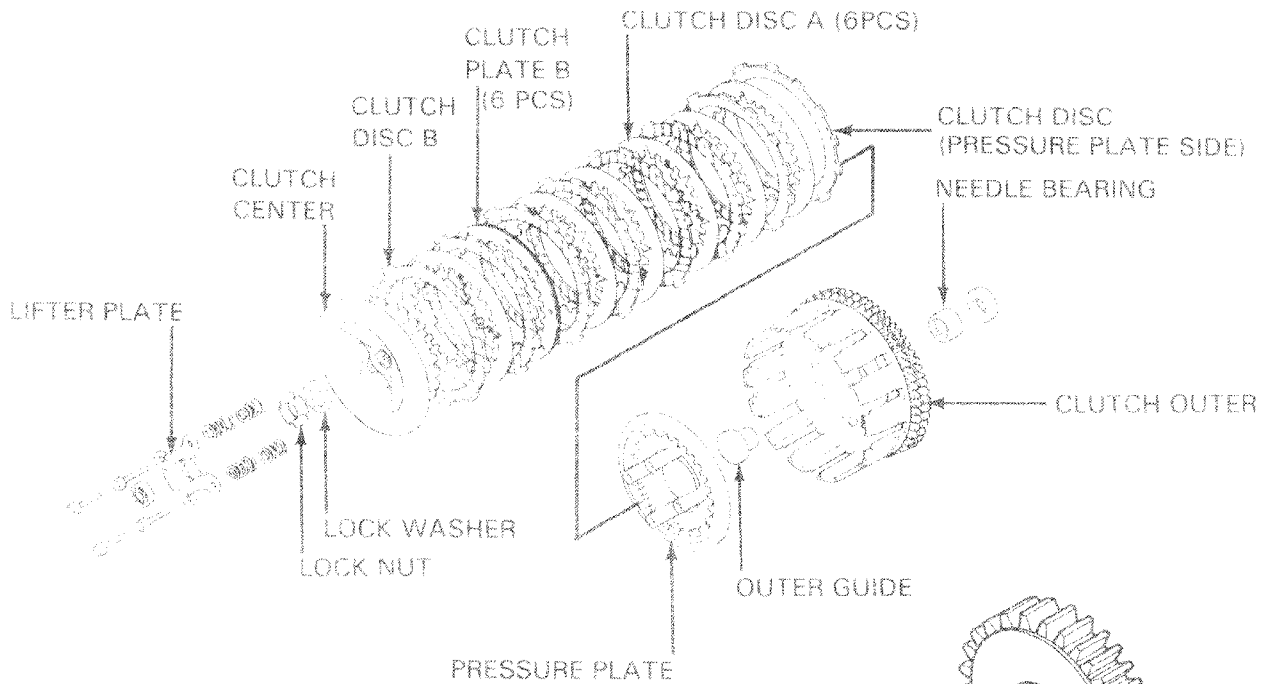
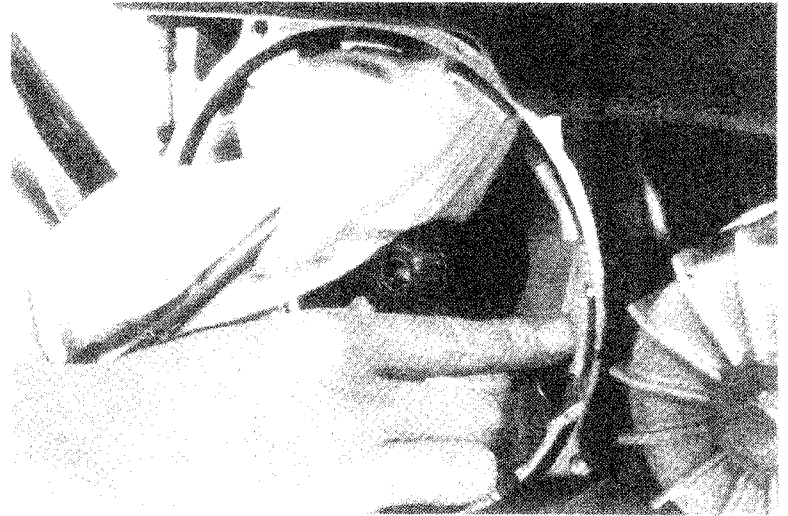

PRIMARY DRIVE GEAR REPLACEMENT

NOTE

Use a GEAR HOLDER (07924-MC70000) to hold the primary drive gear, while you tighten its bolt.

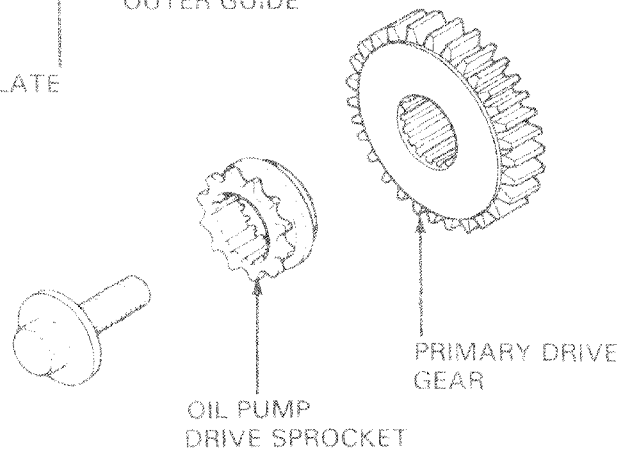



B. COOLING SYSTEM RADIATOR/COOLING FAN REMOVAL

On the Interstate models, remove the fairing.

Remove the seat and fuel tank.

Remove the radiator grille and drain the coolant from the radiator.

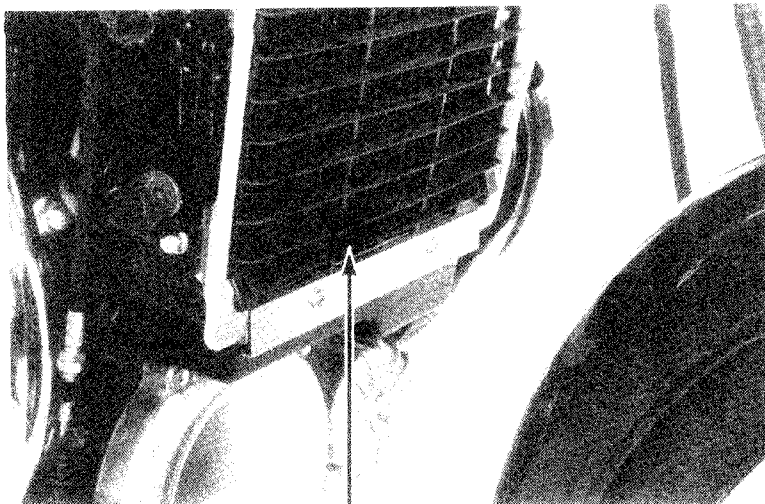

RADIATOR GRILLE

On the Interstate models, remove the following items:

Disconnect the horn wires, remove the retaining bolts and remove the horns from the bracket.

Remove the left side main bracket mounting nut.

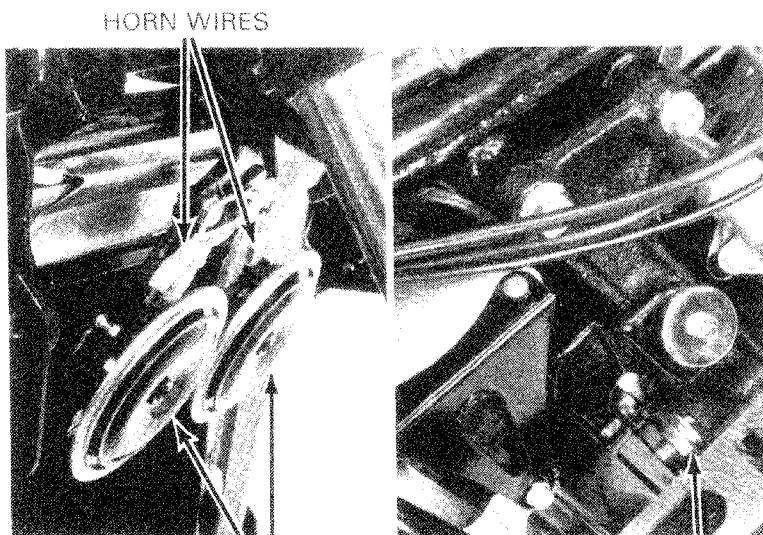

HORN WIRES

HORNS

NUT

WIRE BAND

MAIN BRACKET

Remove the wire band, clutch cable and tachometer cable.

Remove the right side main bracket mounting nuts.

Remove the main bracket.

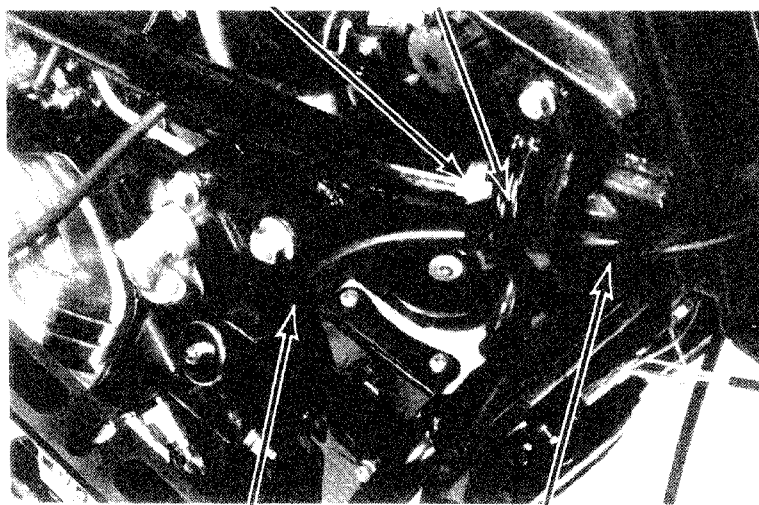

CLUTCH CABLE

TACHOMETER CABLE



Disconnect the overflow tube at the radiator filler neck.

Disconnect the fan motor and the thermostatic switch wire coupler from the wire harness.

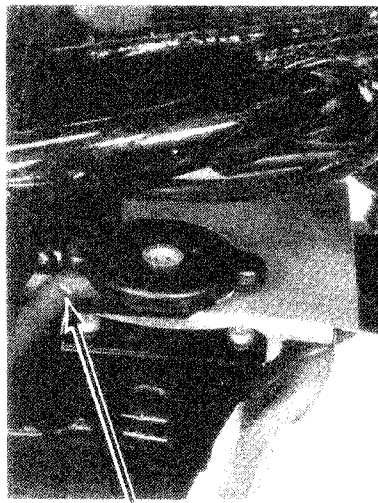

OVERFLOW TUBE

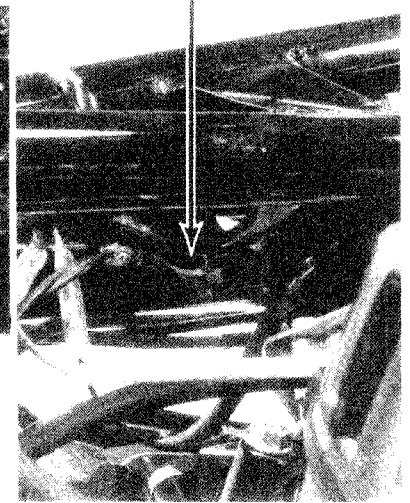

WIRE COUPLER

Remove the right side ignition coil.

Loosen the radiator upper hose band.

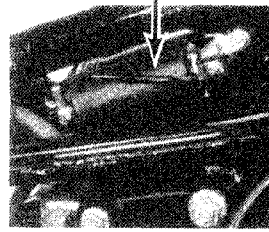

IGNITION COIL



UPPER HOSE BAND

Loosen the radiator's lower hose band.

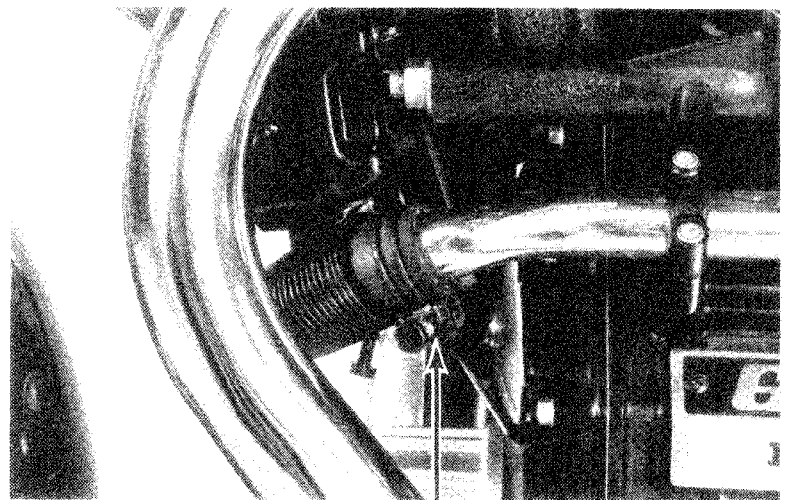

LOWER HOSE BAND



Remove the right and left radiator mounting bolts.

Remove the radiator.

CAUTION:

Do not damage the radiator fins.

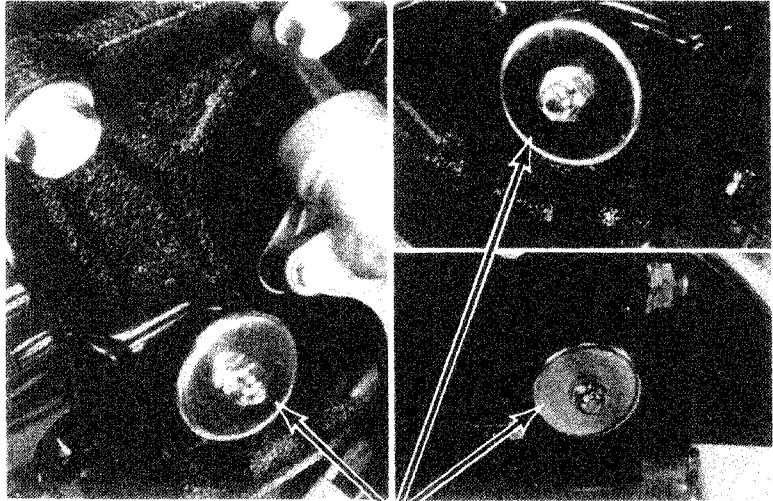

MOUNTING BOLTS

DISASSEMBLY

Remove the radiator's right and left cover bolts.

Separate the cover from the radiator.

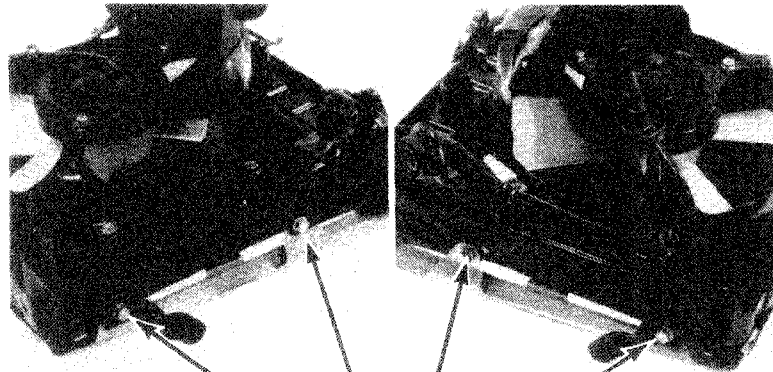

COVER BOLTS

Remove the fan shroud with the fan by removing the four bolts.

Remove the fan attaching screws and remove the fan from the fan shroud.

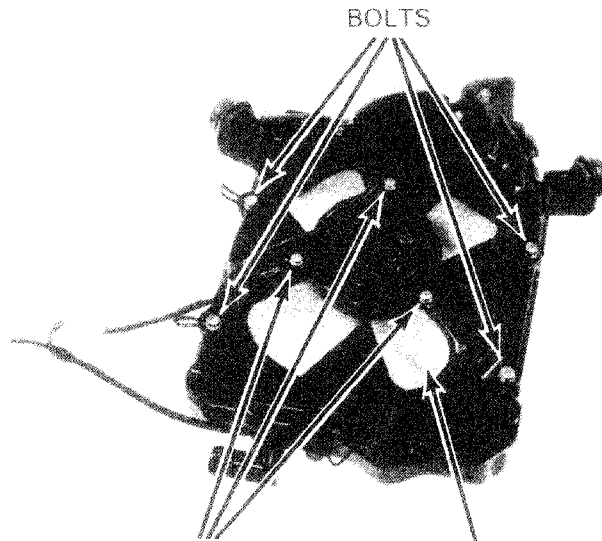

SCREWS

COOLING FAN



Remove the fan attaching nut and pull the fan off the fan motor.

COOLING FAN

NUT

FAN MOTOR

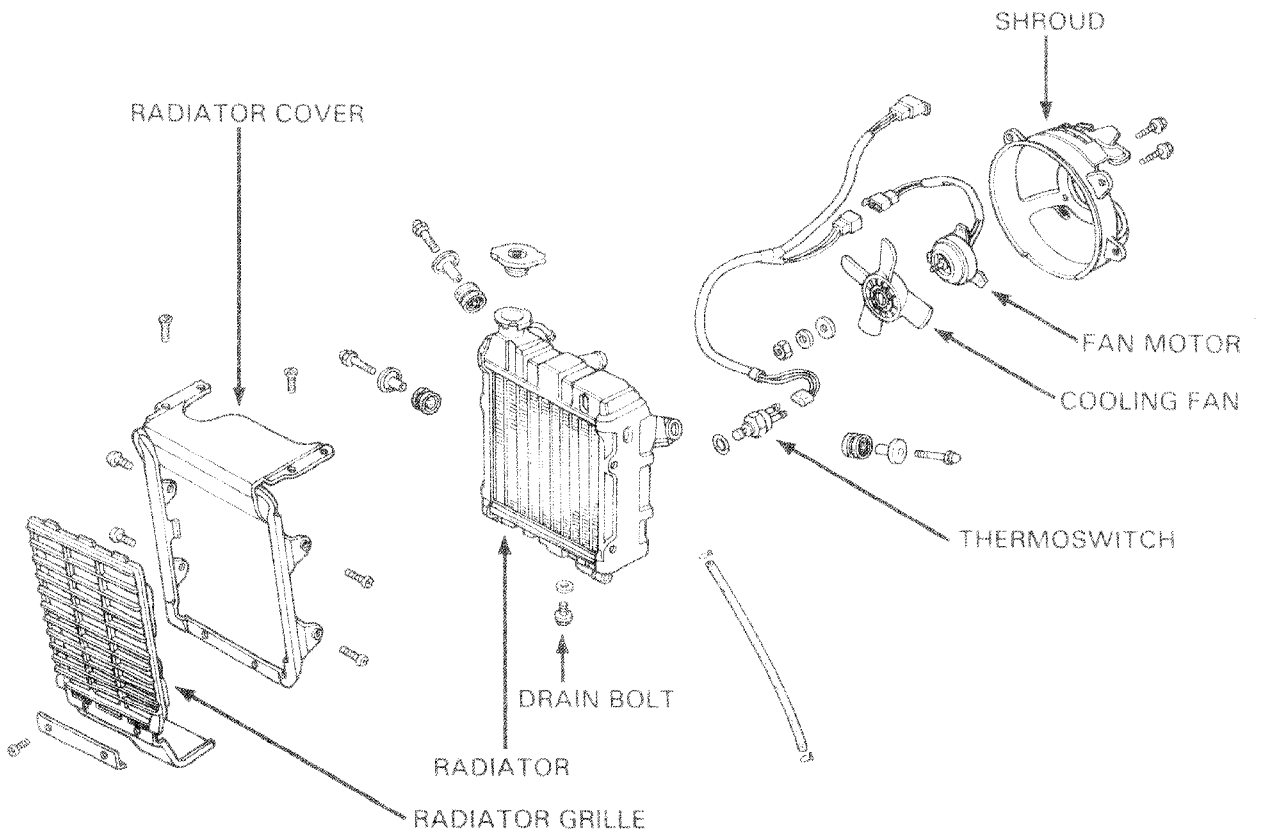
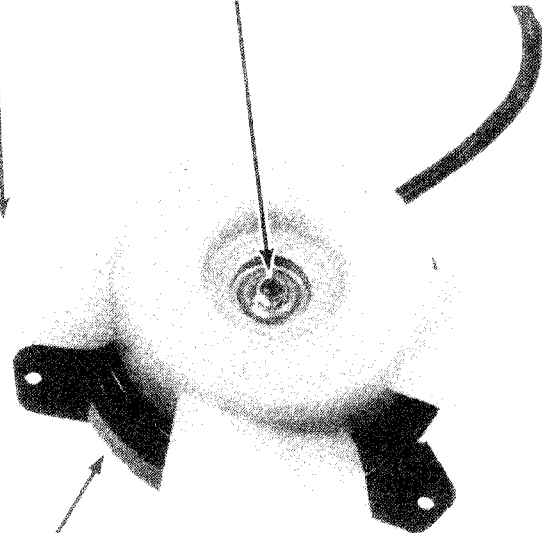



RADIATOR INSPECTION

Inspect the radiator soldered joints and seams for leaks.

Blow dirt out from between core fins with compressed air. If insects, etc., are clogging the radiator, wash them off with low pressure water.

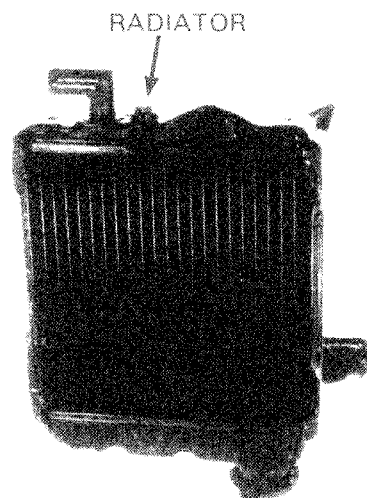

ASSEMBLY/INSTALLATION

Install the fan over the motor shaft.

Apply a locking agent to the fan motor shaft threads, install and torque the plain washer, lock washer and nut.

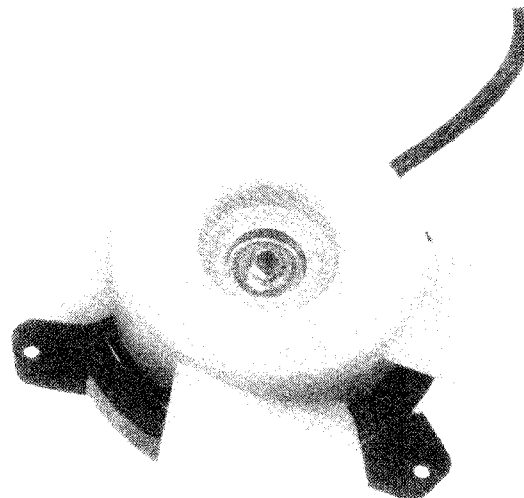

Attach the fan motor to the fan shroud with its TOP mark facing up.

Attach the fan shroud to the radiator.

Install the radiator cover.

Installation of the radiator is essentially the reverse order of removal.

CAUTION:

Do not damage the radiator fins.

After installation, check the radiator and radiator hoses for leaks (page 9-10).

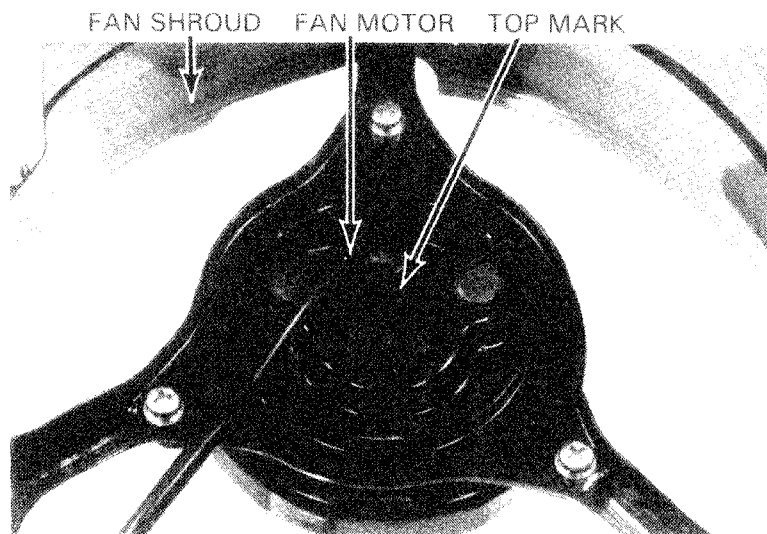



9. CAM CHAIN CAM CHAIN REMOVAL

On Interstate models, remove the fairing (section 20).

Remove the engine (Section 5).

Remove the engine rear cover (Section 8).

Remove the starter reduction gear, fly-wheel and starter driven gear (Section 8).

Remove the chain guide set plate bolts.

Remove the chain guide set plate.

Remove the cam chain tensioner set bolts.

Remove the cam chain tensioner by compressing the push rod while pressing in the steel ball with a flat-end screwdriver as shown.

CAUTION:

The set bolt threads have a special pitch; do not mix this bolt with the normal fasteners. If you install a normal bolt in the set bolt hole, it will ruin the threads.

Remove the chain tensioner slipper.

Remove the cam chain guide.

SET PLATE

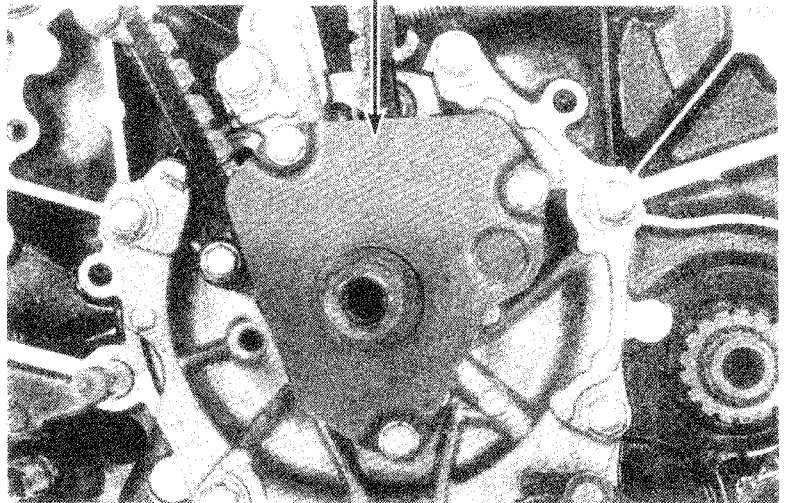

SET BOLT

CAM CHAIN TENSIONER

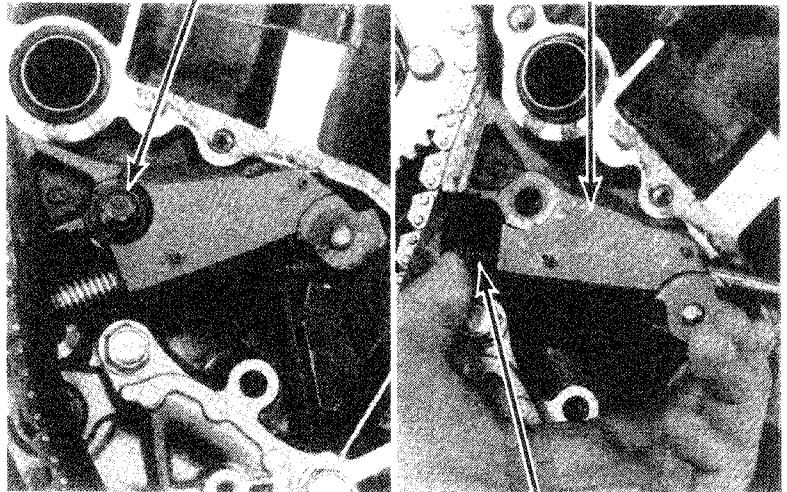

PUSH ROD

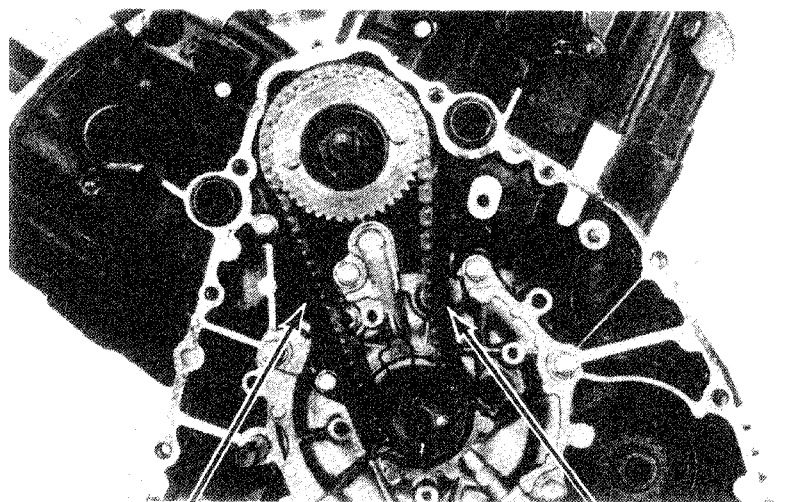

CAM CHAIN GUIDE

CHAIN TENSIONER SLIPPER



Remove the cam sprocket bolts, cam sprocket and cam chain.

CAM SPROCKET SPROCKET BOLTS

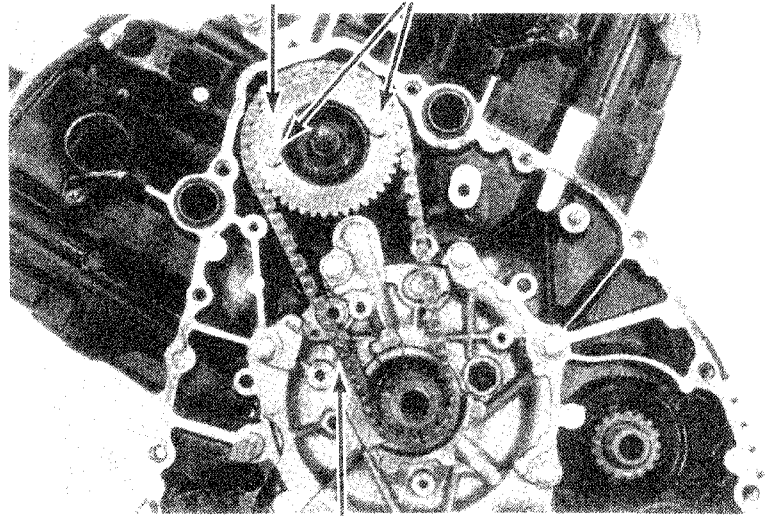

CAM CHAIN

CAM CHAIN/AUTOMATIC CAM CHAIN TENSIONER INSTALLATION

NOTE

After installing the cam chain and cam sprocket, check that the valve timing is correct (page 10-9).

Installation is essentially the reverse order of removal.

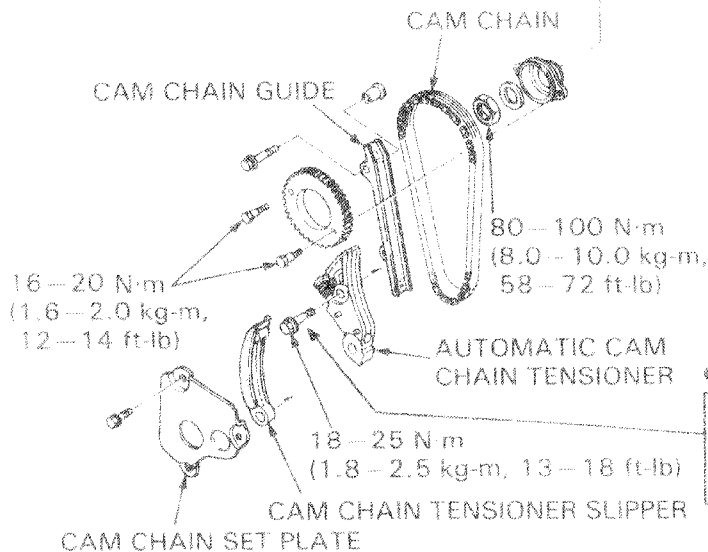
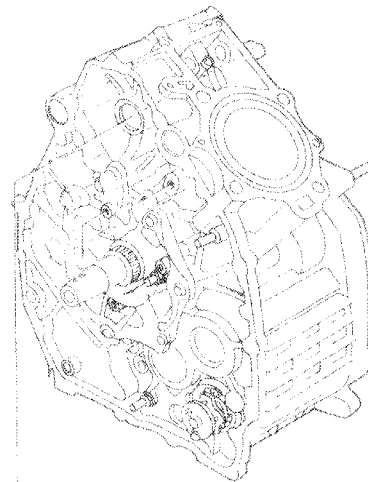

CAUTION:

Be sure to use the correct set bolt. Failure to use the special bolt will ruin the thread hole in the engine case.

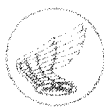

10. TRANSMISSION INSPECTION

Measure and record the O.D. of the mainshaft and countershaft at the locations as shown.

STANDARD SERVICE LIMIT

A: 27.459–27.48 mm (1.0811–1.0819 in)	A: 27.43 mm (1.080 in)
B: 24.959–24.980 mm (0.9826–0.9835 in)	B: 24.93 mm (0.981 in)
C: 19.987–20.000 mm (0.7869–0.7874 in)	C: 19.96 mm (0.786 in)
D: 24.959–24.980 mm (0.9826–0.9835 in)	D: 24.93 mm (0.981 in)
E: 24.991–25.009 mm (0.9839–0.9846 in)	E: 24.96 mm (0.983 in)

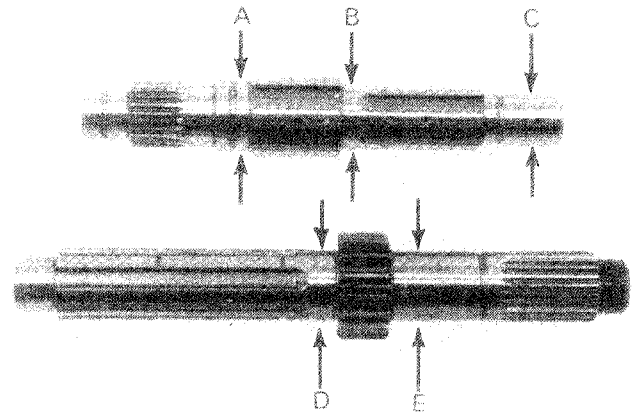

ASSEMBLY

NOTE

Check the gears for freedom of movement or rotation.

Check that all circlips are seated in their grooves.

Lubricate the sliding surfaces of the gears with engine oil.

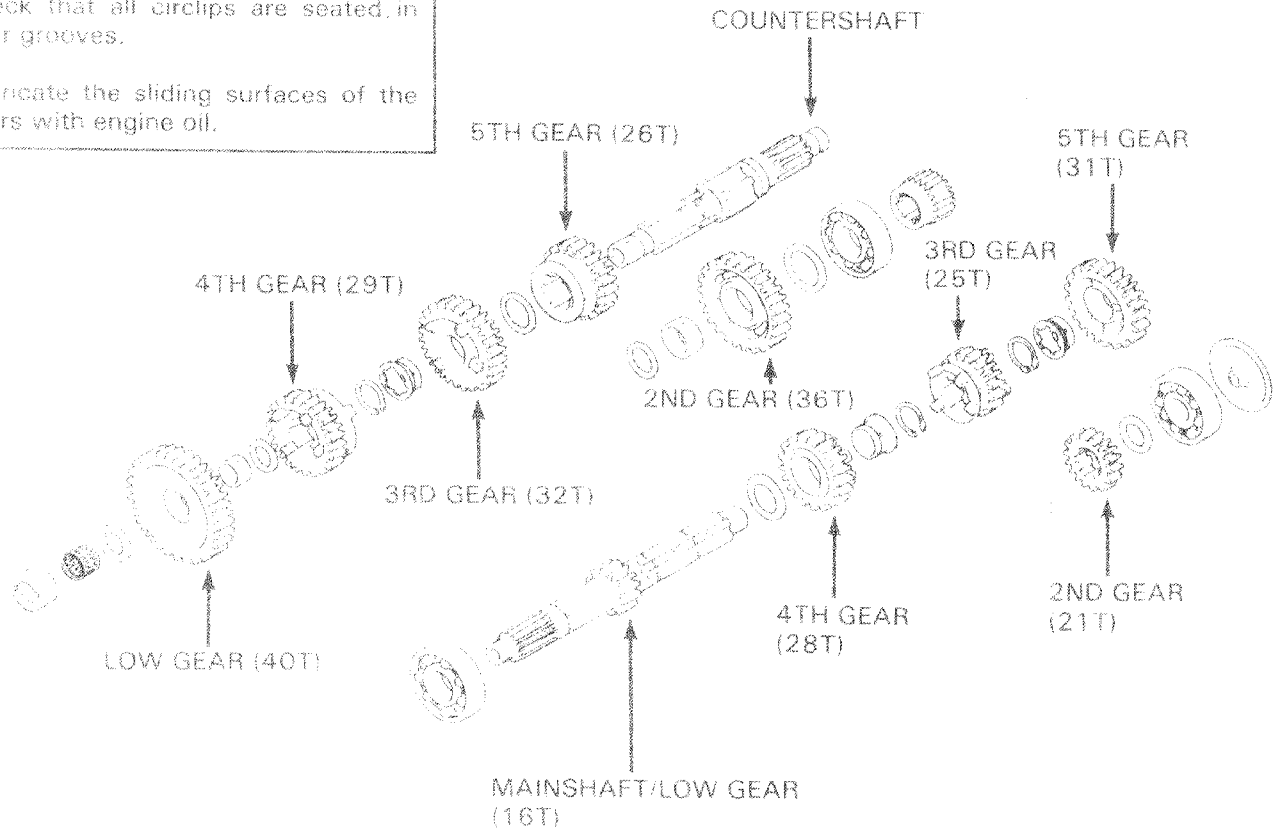



11. FRONT WHEEL/ SUSPENSION

FRONT WHEEL REMOVAL

Raise the front wheel off the ground by placing a block or safety stand under the engine.

Remove the right and left caliper by removing the mounting bolts. Support the calipers so that they don't hang from the brake hoses.

Remove the front axle holder and axle.

NOTE

Do not operate the front brake lever after removing the front wheel. To do so will cause difficulty in refitting the brake disc between the brake pads.

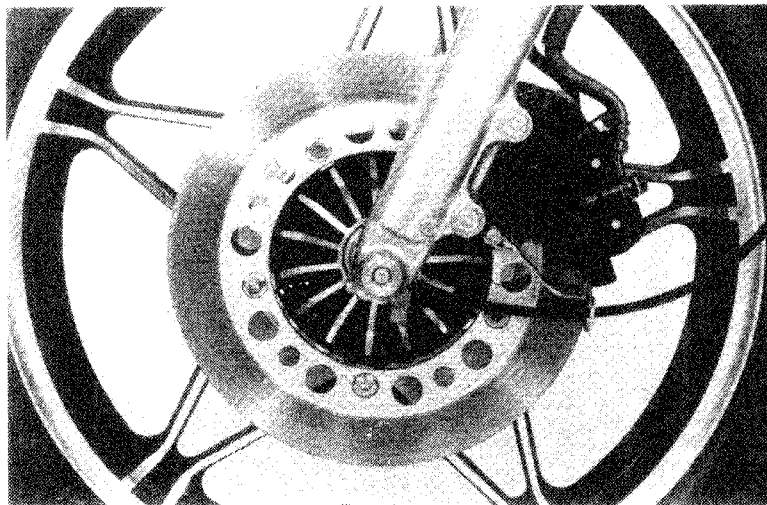

FRONT WHEEL INSTALLATION

Loosely install the axle holder with "ARROW" mark forward.

Insert the axle through the right fork leg and wheel hub, and screw it into the left fork leg.

Make sure the groove on the speedometer gearbox fits into the lug on the left fork leg.

Tighten the axle to specified torque.

**TORQUE: 55–65 N·m (5.5–6.5 kg·m,
40–47 ft·lb)**

Tighten the nuts on the right axle holder to the specified torque starting with the forward nut.

**TORQUE: 18–25 N·m (1.8–2.5 kg·m,
13–18 ft·lb)**

Fit the left caliper over the disc, taking care not to damage the brake pads. Install the caliper mounting bolts and tighten to the specified torque.

**TORQUE: 30–40 N·m (3.0–4.0 kg·m,
22–29 ft·lb)**

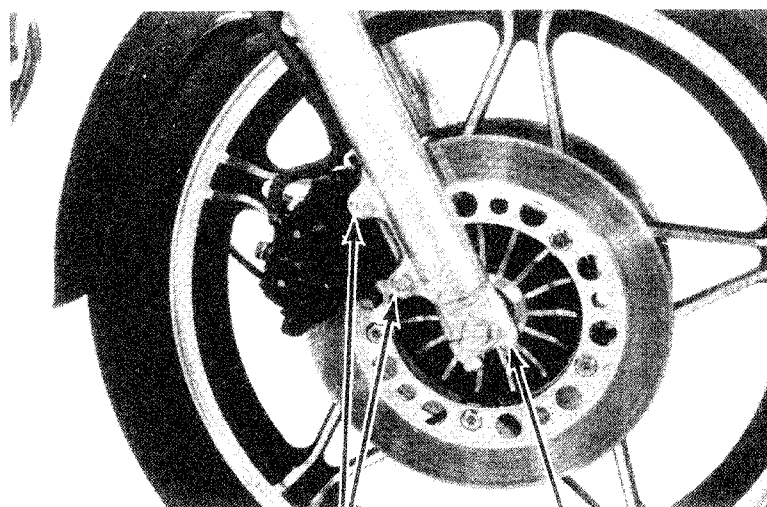

CALIPER MOUNTING BOLTS AXLE HOLDER



Using a 0.7 mm (0.028 in) feeler gauge, measure the clearance between each surface (inside and outside) of the right brake disc and the caliper holder. If the gauge inserts easily, the clearance is correct.

If the feeler gauge cannot be inserted easily, loosen the axle holder nuts and pull the right fork slider outward or push inward until the gauge can be inserted. Then, tighten the holder nuts with the gauge inserted. After tightening, remove the gauge.

Apply the brakes several times, then recheck caliper holder-to-disc clearance.

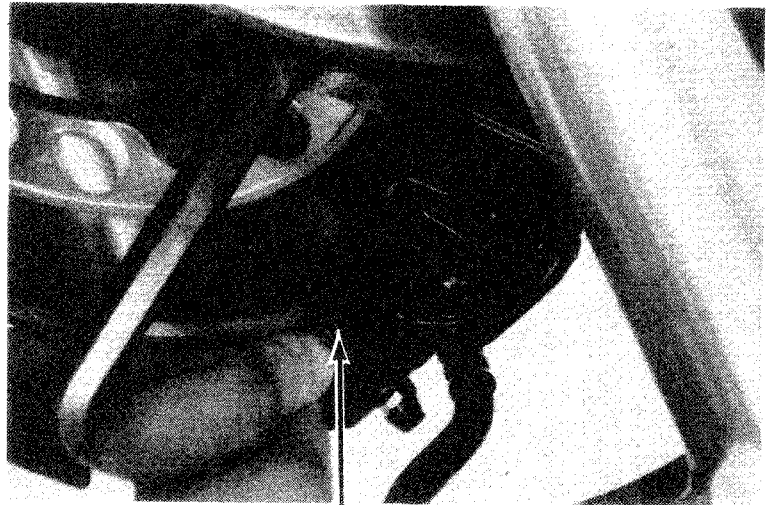

FEELER GAUGE

WARNING

Failure to provide adequate disc-to-caliper holder clearance may damage the brake discs and impair braking efficiency.

FRONT WHEEL ASSEMBLY

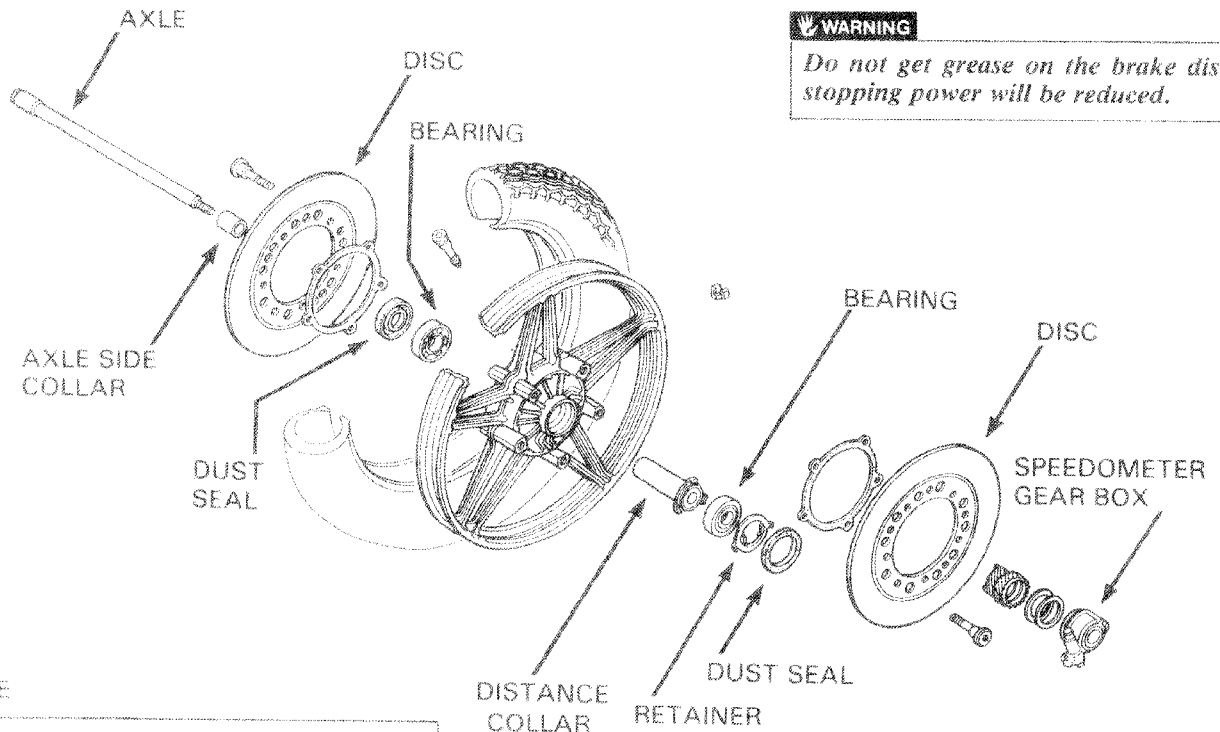

WARNING

Do not get grease on the brake disc or stopping power will be reduced.

NOTE

The cast wheel has no rim band.

The front wheel uses a tubeless tire. For tubeless tire repair, refer to the HONDA TUBELESS TIRE MANUAL.

FORK BRACE

It is necessary to remove the fork brace before removing the front fork.

The front fork and front wheel should be completely assembled, and its bolts tightened, before installing the fork brace. Torque the fork brace socket bolts as specified.

TORQUE: 18–28 N.m (1.8–2.8 kg-m,
13–20 ft-lb)

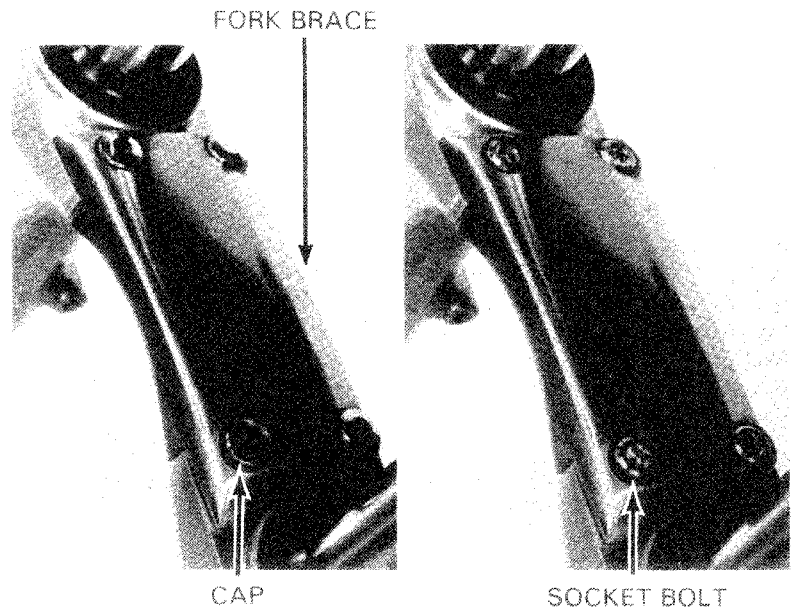

12. REAR WHEEL

REAR WHEEL ASSEMBLY

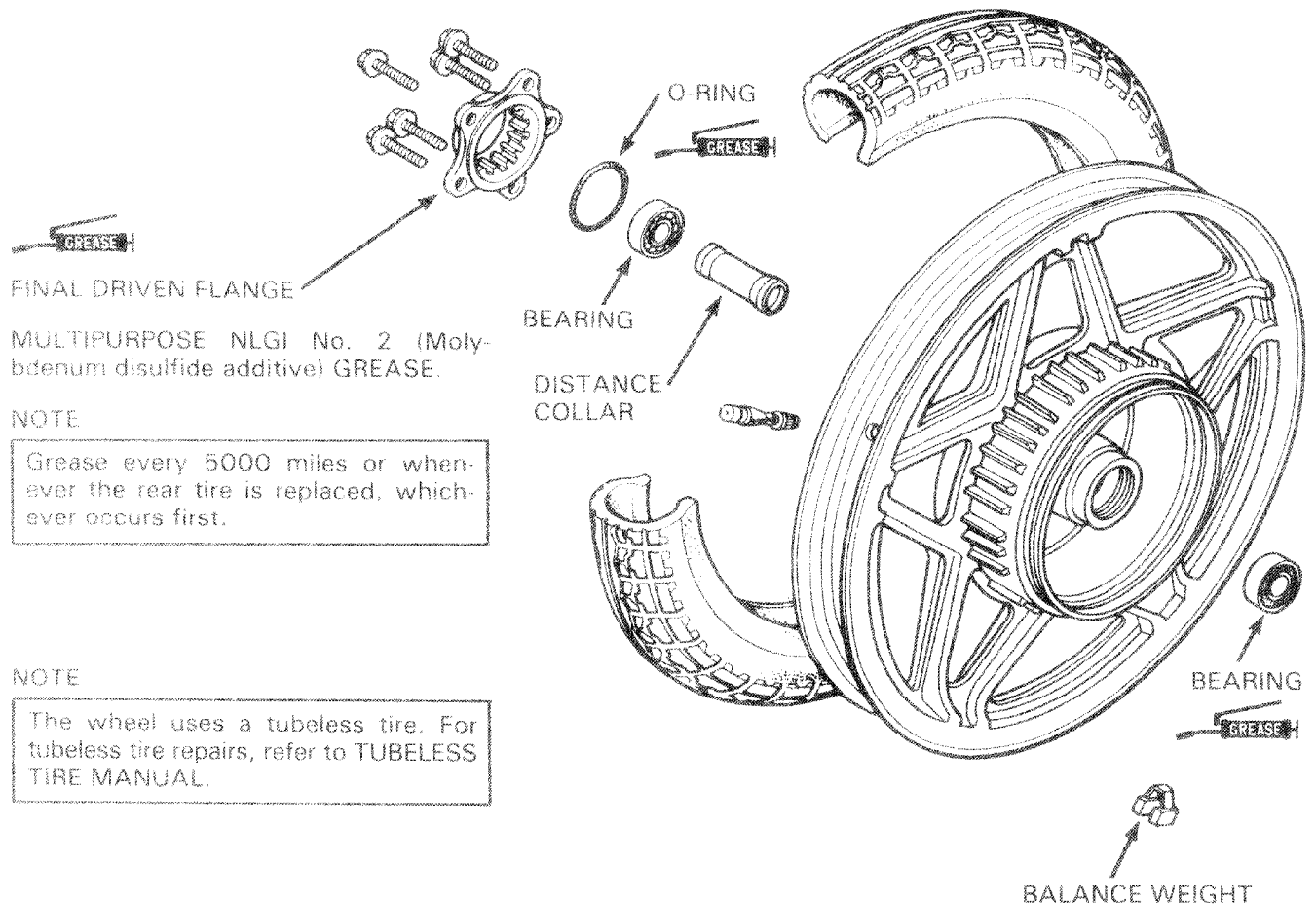

FINAL DRIVEN FLANGE

MULTIPURPOSE NLGI No. 2 (Molybdenum disulfide additive) GREASE.

NOTE

Grease every 5000 miles or whenever the rear tire is replaced, whichever occurs first.

NOTE

The wheel uses a tubeless tire. For tubeless tire repairs, refer to TUBELESS TIRE MANUAL.



13. SWITCHES

THERMOSTATIC SWITCH

The cooling fan motor is actuated by the thermostatic switch.

Run the engine until coolant temperature reaches 88 – 92 °C (191 – 197 °F).

The fan motor should start running. The fan motor should stop when the coolant temperature drops to 83 – 87 °C (182 – 188 °F).

If the fan motor does not start, disconnect the black/blue and green leads from the thermostatic switch and short them together with a jumper wire as shown.

Turn the ignition switch on.

The cooling fan motor should start running.

If it starts, replace the fan thermostatic switch and retest.

If it does not start, check for battery voltage from the black lead (positive) to green (negative) of the fan motor coupler.

If there is no voltage, check for blown or faulty fuse, loose terminals or connectors, or an open circuit.

THERMOSTATIC SWITCH

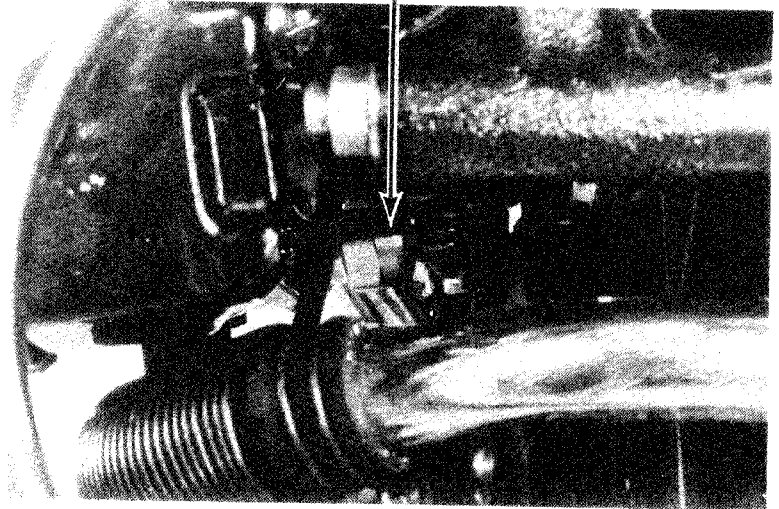

THERMOSTATIC SWITCH LEADS

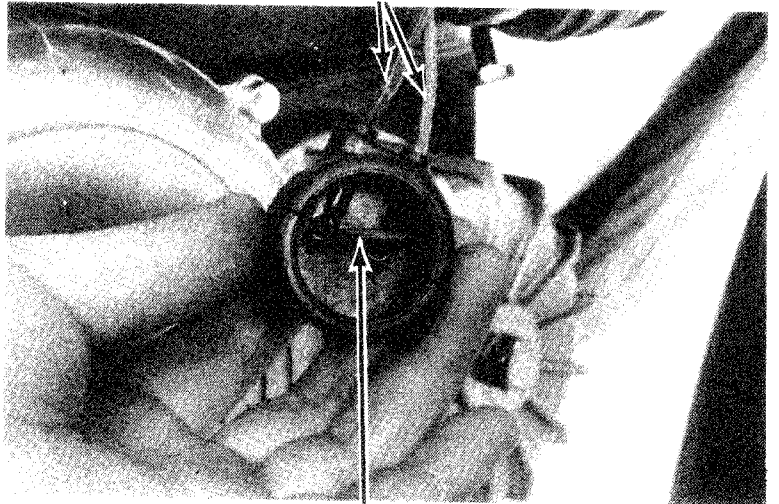

JUMPER WIRE



MEMO

14. WIRING DIAGRAMS

GL650

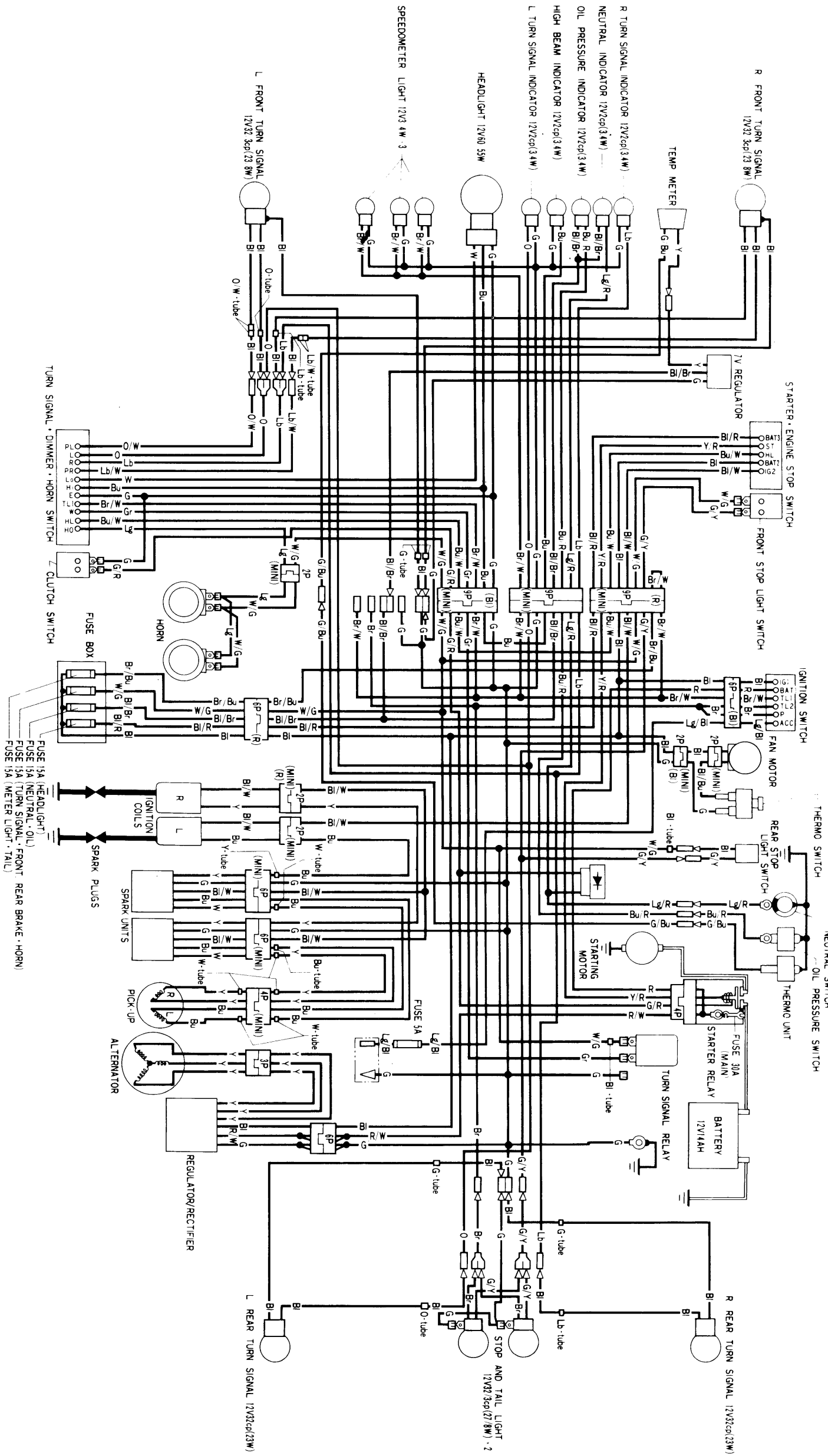

- B BLACK
- Y YELLOW
- Bu BLUE
- G GREEN
- R RED
- W WHITE
- B BROWN
- O ORANGE
- Lb LIGHT BLUE
- Lg LIGHT GREEN
- P PINK
- G GRAY

SWITCH CONTINUITY

IGNITION SWITCH		ENGINE STOP SWITCH		STARTER SWITCH		TURN SIGNAL SWITCH		DIMMER SWITCH		HORN SWITCH										
BATT	IGN	BAT2	IGN2	BAT3	HL	BAT2	ST	W	R	L	TL	PR	PL	HL	H	Lo	Hi	Lo	Hi	E
LOCK	ACC	OFF	OFF	OFF	OFF	OFF	OFF	OFF	OFF	OFF	OFF	OFF	OFF	OFF	OFF	OFF	OFF	OFF	OFF	OFF
ON	ACC	OFF	OFF	OFF	OFF	OFF	OFF	OFF	OFF	OFF	OFF	OFF	OFF	OFF	OFF	OFF	OFF	OFF	OFF	OFF
P																				

0030Z — ME2 — 6700

GL650 INTERSTATE

HONDA
GL650
GL650 INTERSTATE

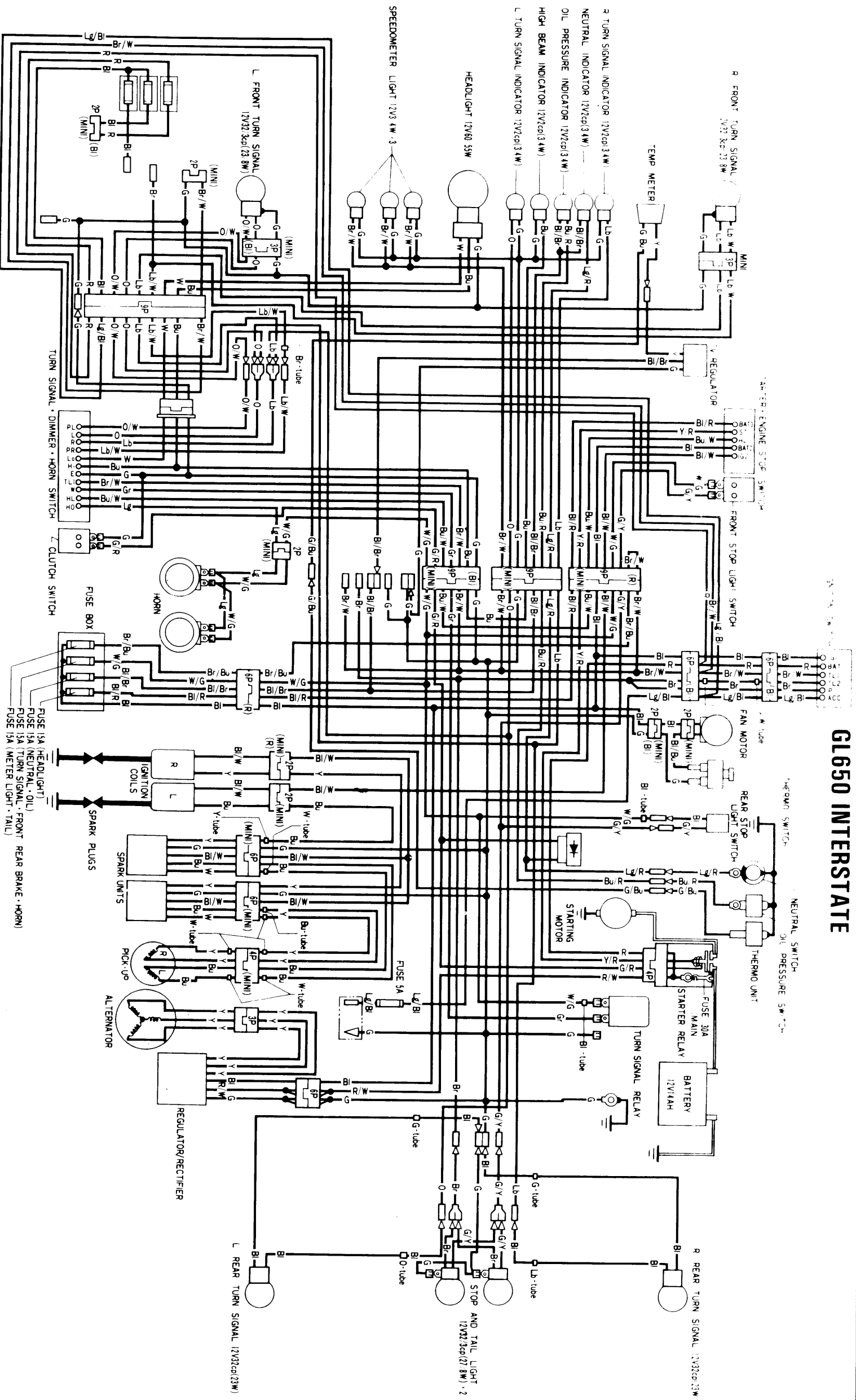

- BI BLACK
- Y YELLOW
- Bu BLUE
- G GREEN
- R RED
- W WHITE
- Br BROWN
- O ORANGE
- Lb LIGHT BLUE
- Lg LIGHT GREEN
- P PINK
- G GRAY

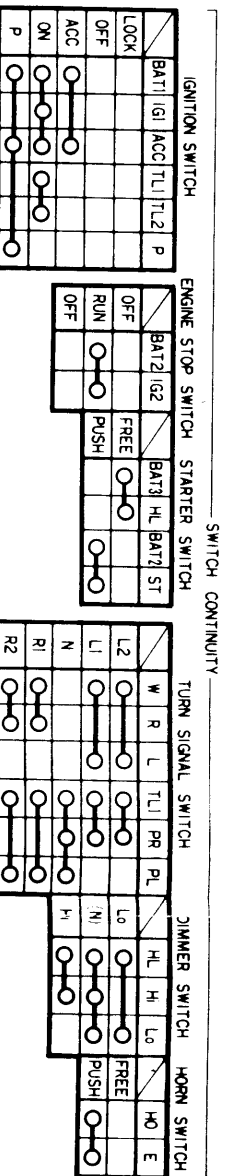

0030Z — ME2 — 7700